

## SURGICAL INSTRUMENTS CATALOGUE

***Raiz & Sajjad Surgical (PVT) LTD.***

*Manufacturers - Exporters & Importers of Surgical, Dental, Laparoscopic,  
Veterinary Instruments & all sort of Scissors*





## INTRODUCTION



*Haji Abdul Islam (late)*

### FOUNDER

Haji Abdul Islam is founder of **Raiz & Sajjad Surgical (Pvt) Ltd.**, he engaged in the business **since 1969** and got good reputation due to excellent services and quality products up-to international standard. Haji Abdul Islam and Haji M. Sarwar were the pioneers to establish this firm and worked hard in this partnership between them erase to success.



*Haji M. Sarwar*

### PRESIDENT

I Haji M. Sarwar & Haji Abdual Islam (late) started manufacturing in 1969 and work hard to achieve the best quality results. Our surgical, Orthopaedic, Laparoscopic, Dental & Veterinary Instruments as well quality scissors of all sort are exporting **Europe, USA, Canada, Latin America, Australia, Africa & Asia.**

My elder son Mr. Intikhab Alam is one of the director of our firm.

We are in position to meet any sort of international market challenges coming a head and we are always ready to meet them in good hand. We have the best quality and best price for our customers around the globe.

Regards

Haji M. Sarwar

E-Mail : [sales@raizent.com](mailto:sales@raizent.com)

# INTRODUCTION



**M.S. Mughal**  
**CHIEF EXECUTIVE**

Being chief executive of our company, I am very much happy to see our company's graph which is always going up. Our old & regular customers are the basic source for referring new customers. Its clear means our customers are much happy with the quality of our products, good prices and delivery times. So definitely there are more liabilities on all of us for more struggles to keep up our company's name always on top ranking and it only could possible with our valuable customers co-operations. Our company is certified with all necessary certifications like **ISO-9001-2008**, **ISO-13485-2003**, **cG.M.P FDA** registered as manufacturer, **CE MARK** registered and so many others from the time of certifications started in Pakistan.

Regards

M.S. Mughal (C.E.O)

E-Mail : [msmughal@raizent.com](mailto:msmughal@raizent.com)



**Ch. M. Intikhab Alam**  
**Q.A & MANAGING DIRECTOR**

*I am pleased to introduce our self as manufacturers exporters & importers of Surgical, Orthopaedic, Laparoscopic, Dental & Veterinary Instruments. Kindly contact us for more information regarding your requirement. We are providing good quality in affordable price. We are also producing RE-USABLE as well DIS-POSABLE instruments.*

*For more information kindly mail us.*

Regards

Ch. Intikhab Alam

E-Mail : [intikhab@raizent.com](mailto:intikhab@raizent.com)



# CERTIFICATION

## Certificate of Registration



The Governing Board of  
Q.A. International Certification Limited  
hereby grants to:

**Raiz & Sajjad Surgical (Pvt) Ltd  
(In Joint Venture With Genevet Ltd-UK)**  
Registration No: QAI/796/154-A

Whose sole/sole director/Company, its right to trade in the Jurisdiction of Registration is a special  
jurisdiction based upon: There is no other jurisdiction for the Registration Company, in or from any other address given  
either in accordance with the audit management power to compliance with ISO 9001:2008

Address to which this Certificate refers

**Jail Road, Sialkot - Pakistan**

Approved Scope to which this Certificate refers:

**Manufacturing of Surgical, Dental, Veterinary, Manicure, Pedicure Instruments, Hollowware  
Products, Sterilizer and Autoclave, Hospital Furniture and Radiological Accessories**  
(Further clarification regarding the Scope of this Certificate and its applicability of  
ISO 9001:2008 requirements may be obtained by contacting the organization)

Signed for and on behalf of the Board

CHAIRMAN  
A. J. Duffell

SCHEME MANAGER  
A. Linn

Certificate Issue Date: 25th September 2007 - Certificate Expiry Date: 26th October 2010  
Date of Initial Registration: 27th October 2007 - Re-assessment Date: 26th October 2011  
The Certificate of Registration is granted subject to the Regulations approved by the Board

### QA INTERNATIONAL

Q.A. International Certification Ltd  
27-28th Floor  
100 Broad Street  
London  
EC2M 2DQ  
UK  
Tel: +44 (0) 20 7543 3000  
Fax: +44 (0) 20 7543 3001  
www.qai.co.uk



## Certificate of Registration



The Governing Board of  
Q.A. International Certification Limited  
hereby grants to:

**Raiz & Sajjad Surgical (Pvt) Ltd  
(In Joint Venture With Genevet Ltd-UK)**  
Registration No: QAI/796/154-B

Whose sole/sole director/Company, its right to trade in the Jurisdiction of Registration is a special  
jurisdiction based upon: There is no other jurisdiction for the Jurisdiction of Company, in or from any other address given  
either in accordance with the audit management power to compliance with the requirements of  
ISO: 13485:2003.

Address to which this Certificate refers

**Jail Road, Sialkot - Pakistan**

Approved Scope to which this Certificate refers:

**Manufacturing of Inert Surgical, Dental, Manicure, Pedicure Instruments and Hollowware**  
(Further clarification regarding the Scope of this Certificate and its applicability of  
ISO: 13485:2003 requirements may be obtained by contacting the organization)

Signed for and on behalf of the Board

CHAIRMAN  
A. J. Duffell

SCHEME MANAGER  
A. Linn

Certificate Issue Date: 25th September 2007 - Certificate Expiry Date: 26th October 2010  
Date of Initial Registration: 27th October 2007 - Re-assessment Date: 26th October 2011  
The Certificate of Registration is granted subject to the Regulations approved by the Board

### QA INTERNATIONAL

Q.A. International Certification Limited  
27-28th Floor  
100 Broad Street  
London  
EC2M 2DQ  
UK  
Tel: +44 (0) 20 7543 3000  
Fax: +44 (0) 20 7543 3001  
www.qai.co.uk

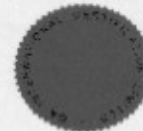

# CERTIFICATION



## Raiz & Sajjad Surgical (Pvt.) Ltd.

JAIL ROAD-P.O.BOX 2947, SIALKOT, 1 - PAKISTAN.

Ph. # +92 52 4274284 / 4293451  
Fax # +92 52 4264284 / 4293450  
msmughal@razient.com  
rsent@brain.net.pk  
www.raizent.com

July 18, 2009

### EC DECLARATION OF CONFORMITY

We,

**RAIZ & SAJJAD SURGICAL (PVT) LTD.**  
**(In Joint Venture With Genevet Ltd-UK)**  
**Jail Road, Sialkot-1, Pakistan.**

Hereby declare that we fall within manufacturers of Class 1 device and the devices produced by us are:

- a) **B3** Dental Instruments Non Active
- b) **H5** Surgical Instruments-non active
- c) **H9** Surgical Instruments and accessories

Meet the essential requirement of Directive No. 93/42/EEC dated June 14, 1993. We prepare and maintain technical documentation for each device as requires by Annex-VII of the directive 93/42/EEC. We shall maintain these documentations for 5 years from the data of their production. The technical documentation can be made available to the competent authority on demand.

Director  
**Intikhab Alam Choudhary**

For  
**RAIZ & SAJJAD SURGICAL (PVT) LTD.**  
**(In Joint Venture With Genevet Ltd-UK)**



4<sup>th</sup> Floor, Zone A  
Sikida House  
87, London Road  
LONDON  
SE1 6LH

Direct Line: 020 2952 2027

SAE 188/V855/10

17/06/2009

DEPARTMENT OF HEALTH

#### CERTIFICATE OF FREE SALE FOR EXPORTATION OF MEDICAL PRODUCTS

It is hereby certified that, on the basis of information provided, the products named below, which are manufactured by: Raiz&Sajjad Surgical Limited, 100A St James Rd, Stratford, London, E15 1RN, United Kingdom, have been affixed with the CE mark under the Medical Devices Directive 93/42/EEC and the UK Medical Devices Regulations 2002 SI No. 616, as amended, and therefore may be freely sold in all member states of the European Economic Area including the United Kingdom.

Where appropriate, Certificates of Free Sale are issued as a service to UK exporters. A Certificate of Free Sale should not be taken as an official endorsement of any product that is referred to on the certificate.

Surgical Instruments - Various



*Tracy Ellis*  
Mrs. Tracy Ellis  
MPI-Business Support  
Manager  
Signed on Behalf of the  
Department of Health



### THE SIALKOT CHAMBER OF COMMERCE & INDUSTRY

P.O. Box 1876, Shah Wali-C-Alwan-E-Sarraf-D-Tajawal, Sialkot - 51310, Pakistan  
Tele: (052) 4261881 - 4264982 - 4261883, Green: Commerce, Fax # +92-052-4264935-4267929  
Website: www.scci.com.pk, E-MAIL: scci@ccscc.com.pk

Ref. DS05805 *05 inf*

Dated: 05.05.2009

#### FREE SALES CERTIFICATE

It is hereby certified that the Surgical and Dental Instruments as per attached catalogue, are manufactured by M/s. Raiz & Sajjad Surgical (Pvt) Limited, Jail Road, Sialkot-Pakistan are lawfully sold or legally distributed in Pakistan and abroad including USA and Europe in accordance with the statutory requirements.







This certificate is issued for custom purpose on specific request of the member firm.

*Tariq Malik*  
Tariq Malik  
Deputy Secretary

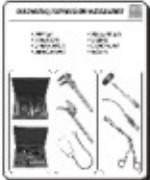

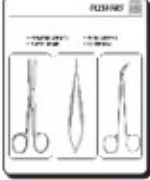
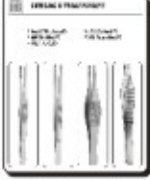









## TABLE OF CONTENTS

S. No.			Page No.
01	<b><i>Diagnostic / Preparation Instruments</i></b>		01
02	<b><i>Scalpel Holders, Amputation &amp; Saws</i></b>		25
03	<b><i>Scissors</i></b>		37
04	<b><i>Dressing &amp; Tissue Forceps</i></b>		95
05	<b><i>Haemostatic Forceps</i></b>		120
06	<b><i>Needle Holders</i></b>		162
07	<b><i>Retractors</i></b>		202
08	<b><i>Cardiovascular &amp; Thoracic Instruments</i></b>		289

# TABLE OF CONTENTS



S. No.			Page No.
09	<i>Intestinal &amp; Rectal Instruments</i>		331
10	<i>Urology Surgery</i>		350
11	<i>Gynecology / Obstetrics</i>		360
12	<i>Neurosurgery Instruments</i>		401
13	<i>Orthopaedics</i>		420
14	<i>Ear, Nose, Throat Surgery</i>		493
15	<i>Hollow Wares</i>		561
16	<i>Surgical Instrument Sets</i>		570





## TABLE OF CONTENTS

S. No.			Page No.
17	<i>Index</i>		584
18	<i>Ophthalmology Instruments</i>	<i>(Separate Catalogue)</i>	
19	<i>Dental Surgery Instruments</i>	<i>(Separate Catalogue)</i>	
20	<i>Beauty Care Instruments</i>	<i>(Separate Catalogue)</i>	
21	<i>Hospital Furniture Products</i>	<i>(Separate Catalogue)</i>	
22	<i>Veterinary Instruments</i>	<i>(Separate Catalogue)</i>	
23	<i>X-Ray (Radiology) Accessories</i>	<i>(Separate Catalogue)</i>	

# DIAGNOSTIC/PREPARATION INSTRUMENTS



- **HAMMERS**
- **STETHOSCOPE**
- **CATHER FORCEPS**
- **LARYNGOSCOPES**
- **DISSECTING KITS**
- **CALIPERS**
- **SUCTION TUBES**
- **TROCARS**

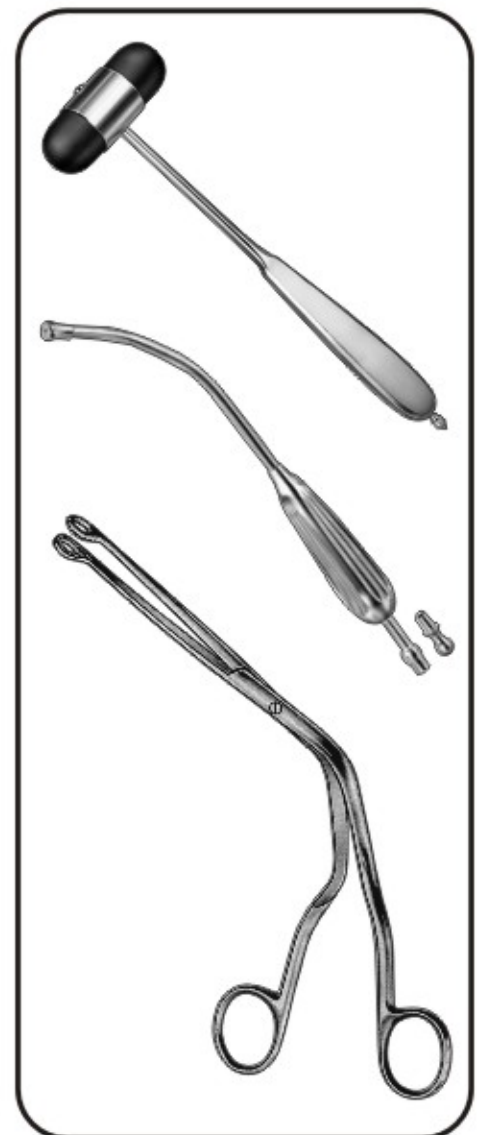
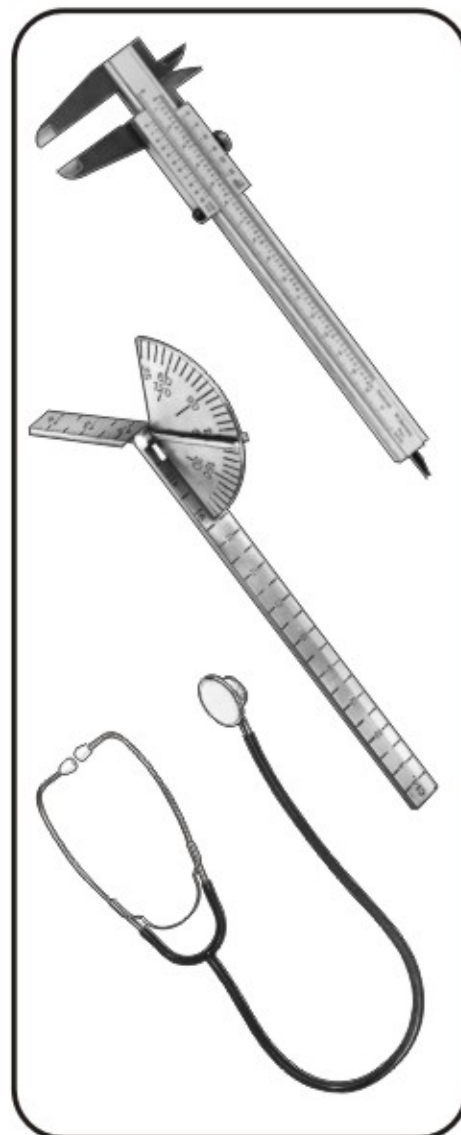



## PERCUSSION HAMMERS

Perkussionshämmer  
Martillos de percusion

Marteaux-percuteurs  
Martelli percussori



**NEURO-DUOFLEX**  
11-001-220  
22 cm, 8 3/4"



**DEJERINE**  
11-002-200  
20 cm, 8"



**DEJERINE**  
11-003-200  
20 cm, 8"



**TROEMNER**  
11-004-245 145 g  
11-005-245 175 g  
11-006-245 235 g  
24.5 cm, 9 3/4"  
spare rubber



**TROEMNER-SIMPLEX**  
11-007-210  
21 cm, 8 1/4"



**BUCK**  
11-008-185  
18.5 cm, 7 1/4"



**BUCK  
HAMMER**  
11-009-180  
18 cm, 7"



**TAYLOR**  
11-010-180 18 cm, 7"  
11-011-200 20 cm, 8"



**TAYLOR**  
11-012-180  
18 cm, 7"

# PERCUSSION HAMMERS



Perkussionshämmer  
Martillos de percusion

Marteaux-percuteurs  
Martelli percussori



**BABINSKY**  
11-013-220  
22 cm, 8 3/4"



**BABINSKY**  
11-014-220  
22 cm, 8 3/4"



**RABINER**  
11-015-255  
25.5 cm, 10"  
with needle & brush



**BERLINER**  
11-016-200  
20.0 cm, 8"



**TRAUBE**  
11-017-160  
16 cm, 6 1/4"



**WARTENBERG**  
11-018-190  
19 cm, 7 1/2"



## STETHOSCOPES

Stethoskope  
Estetoscopios

Stéthoscopes  
Stetoscopi



**DUPLEX**  
11-019-000  
super lightweight



**DUPLEX-BABY**  
11-020-000  
super lightweight



**ANAESTOPHON**  
11-021-000  
super lightweight



**PINARD WOODEN**  
11-022-180  
18 cm, 7"



**PINARD ALUMINIUM**  
11-023-150  
15 cm, 6"



**WEBER**  
11-024-090  
9.0 cm, 3 1/2"  
Aesthesiometer

# CATHETER INTRODUCING FORCEPS

Kathetereinführzangen  
Pinzas para catéteres

Pinces pour introduire les sondes  
pinze per introdurre le sonda



**MAGILL**  
11-025-170  
17 cm, 6 3/4"

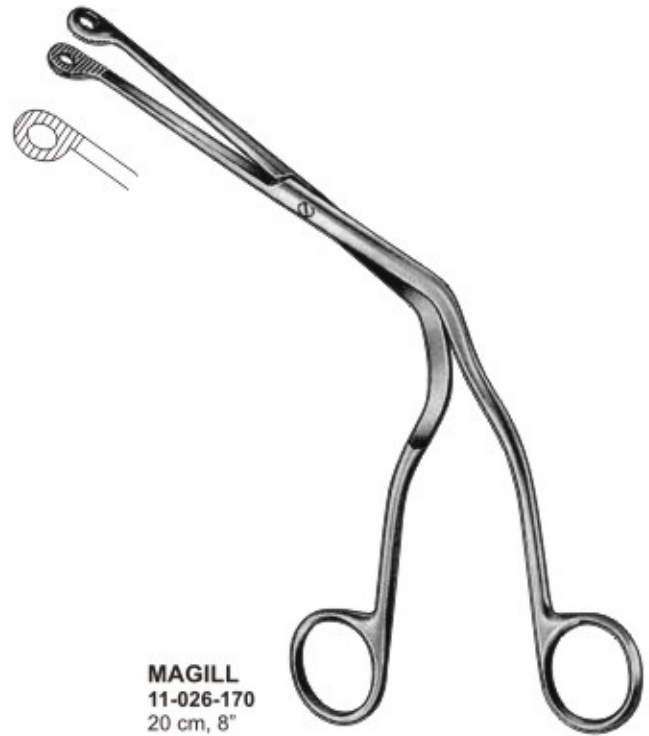

**MAGILL**  
11-026-170  
20 cm, 8"

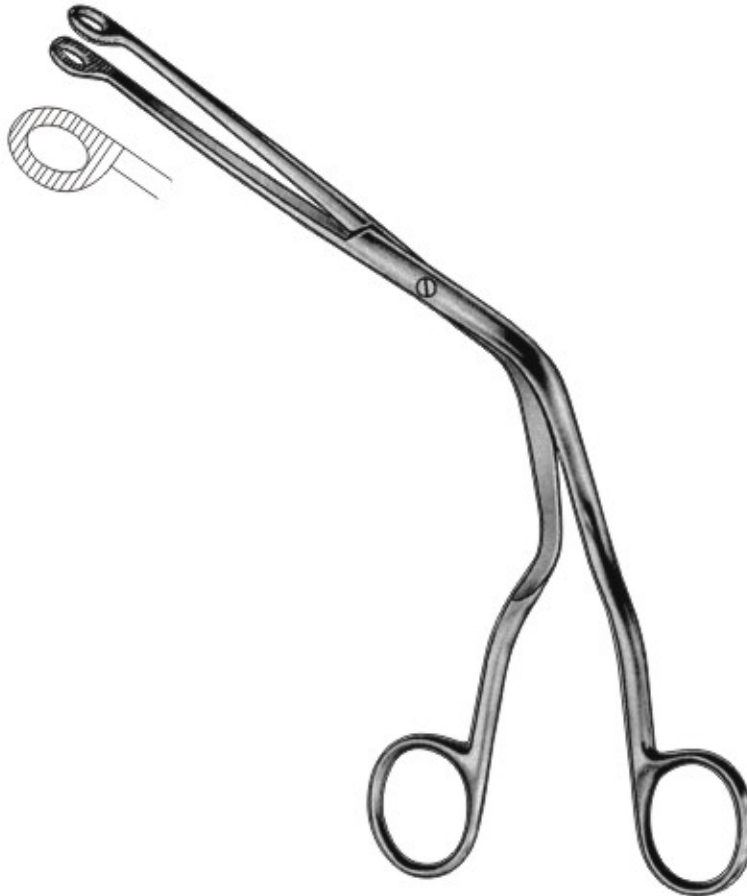

**MAGILL**  
11-027-170  
25 cm, 10"



## DIAGNOSTIC SETS WITH STANDARD ILLUMINATION

Kaltlicht-Laryngoskope und Zubehör  
Laringoscopios de luz fría y Accessories

Laryngoscopes de lumière froide et accessoires  
Laringoscopi di luce fredda ed accessori



**OTOSCOPE SET** (color available)  
11-054-000



**MINI OTOSCOPE SET**  
11-056-000



**OTOSCOPE SET**  
11-055-000



**OTOSCOPE SET**  
11-059-000



**DIAGNOSTIC SET**  
11-033-000



**OTOSCOPE /  
OPHTHALMOSCOPE SET**  
11-057-000



**DIAGNOSTIC SET**  
11-058-000



**GUEDEL-NEGUS**

**11-034-00** Battery handle only  
Fiber Optic  
Laryngoscope set  
with 4 blades  
(fig. 01 to 04) in  
wooden/ rexin box.



**MCINTOSH**

**11-039-00**  
Fiber Optic Laryngoscope set  
with 4 blades  
(fig. 01 to 04) in wooden/ rexin box.

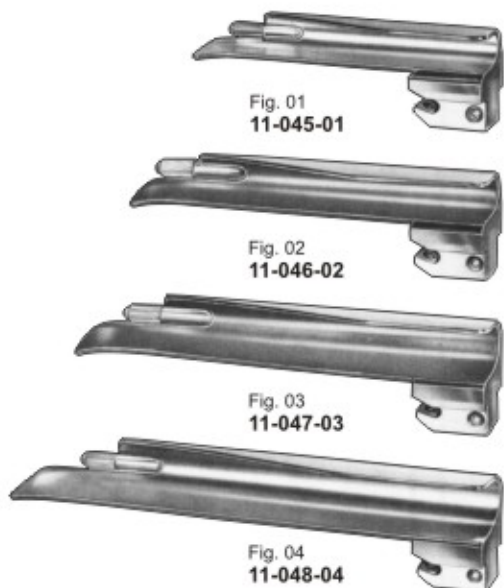

Fig. 01  
11-045-01

Fig. 02  
11-046-02

Fig. 03  
11-047-03

Fig. 04  
11-048-04



**BATTERY HANDLE**  
**11-049-250**  
without battery  
Use with battery - Size C  
(11-045-01 - 11-048-04  
11-050-01 - 11-053-04)

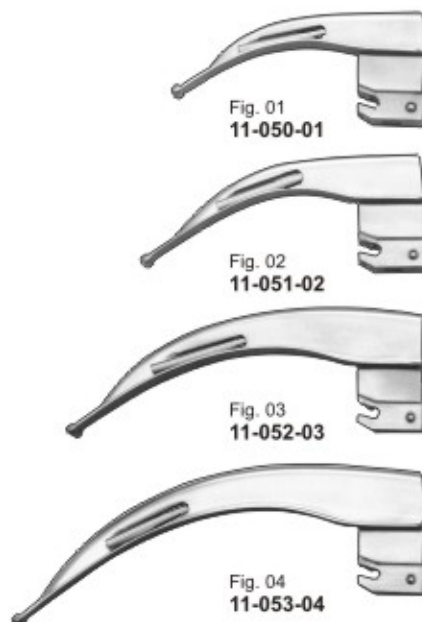

Fig. 01  
11-050-01

Fig. 02  
11-051-02

Fig. 03  
11-052-03

Fig. 04  
11-053-04





# LARYNGOSCOPE & ACCESSORIES

Laryngoskope und Zubehör  
Laringoscopios y Accessories

Laryngoscopes et accessories  
Laringoscopi ed accessori



## GUEDEL-NEGUS / MILLER

**11-061-000**  
with three blade  
blades No. 1 to 3  
complete, in case.

**11-062-000**  
With four blade  
blades No. 1 to 4  
complete, in case.



## FOREGGER

**11-074-000**  
with three Four Blades  
complete, in case.



**11-063-001**  
for children  
working length  
70 mm



**11-064-002**  
for adolescents  
working length  
90 mm



**11-065-003**  
for women  
working length  
110 mm



**11-066-004**  
for men  
working length  
175 mm



**11-075-001**  
for children  
working length  
70 mm



**11-076-002**  
for adolescents  
working length  
90 mm



**11-077-003**  
for women  
working length  
110 mm



**11-078-004**  
for men  
working length  
175 mm

# LARYNGOSCOPE CONVENTIONAL & FIBEROPTIC SET(DOUBLE SET)

*Kaltlicht-Laryngoskope und Zubehör*  
*Laringoscopios de luz fría y Accessories*

*Laryngoscopes de lumière froide et accessoires*  
*Laringoscopi di luce fredda ed accessori*



## CONVENTIONAL SET



**CONVENTIONAL SET**  
**11-079-000**  
**MAC + MILLER COMBO**  
Double Set of 10 Pcs.  
4 Miller Blades  
4 Mac Blades  
1 Handle Small  
1 Handle Medium

## FIBEROPTIC SET

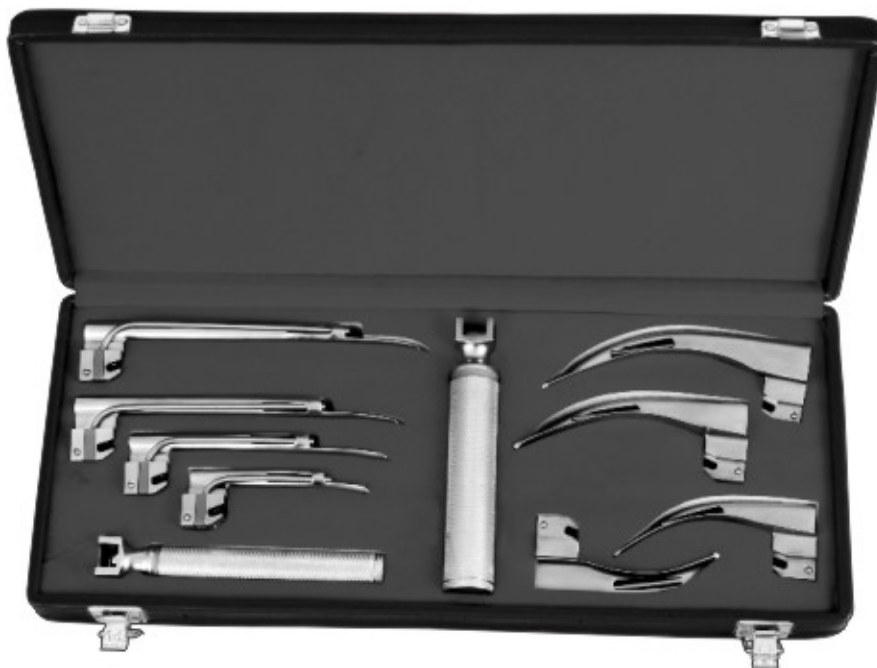

**MAC + MILLER COMBO SET**  
**11-080-000**  
Double Set of 10 Pcs.  
4 Miller Blades  
4 Mac Blades  
1 Handle Small  
1 Handle Medium



## FIBEROPTIC & DISPOSABLE LARYNGOSCOPE SET

Kaltlicht-Laryngoskope und Zubehör  
Laringoscopios de luz fría y Accessories

Laryngoscopes de lumière froide et accessoires  
Laringoscopi di luce fredda ed accessori

### FIBEROPTIC SETS



**MAC SET**  
11-081-000  
Set of 5 pcs.



**MILLER SET**  
11-082-000  
Set of 5 pcs.

### DISPOSABLE LARYNGOSCOPE SETS



**MAC DISPOSABLE SET**  
11-083-000  
Set of 4 Blade + 1 Handle



**MILLER DISPOSABLE SET**  
11-084-000  
Set of 4 Blade + 1 Handle

Diagnostik-bestecke  
Diagnostic Sets

## DISSECTING KITS

Estuches de diagnostico  
Combinazioni per diagnostica

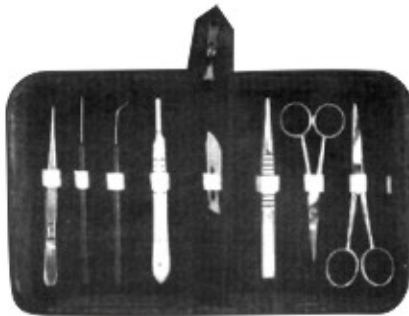

### 11-085-001

Set of 9 Pcs.

- Dissecting Forceps 11.5cm Sharp Point.
- Teasing needle Sharp STR.
- Teasing Needle Sharp Angular.
- B.P Handle No.4.
- Blade No. 22.
- Thumb Forcep T.O.E 13cm.
- Dissecting Scissor STR 11.5cm.
- Dissecting Scissor STR 13cm.
- Zipper Case Inside Red Velvet.

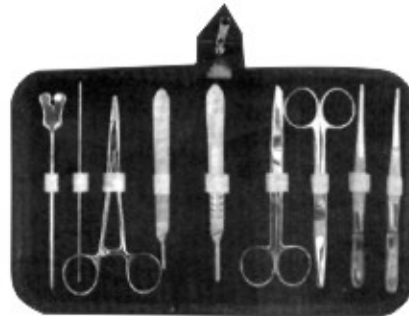

### 11-086-002

Set of 10 Pcs.

- Grooved Director with Tongue Tie 14cm.
- Probe Double 14cm.
- Mayo Hegar Needle Holder 14cm.
- B.P Handle No.3
- B.P Handle No.4
- Dressing Scissor 14cm S/B STR.
- Dressing Scissor 14cm S/B CVD.
- Dressing Forcep 1x2 teeth 14cm.
- Dressing Forcep Serrated 14cm.
- Zipper Case Inside Red Velvet.



### 11-087-003

Set of 10 Pcs.

- Probe Double 13cm.
- 2PCS. Scalpel S.S.
- Grooved Director With Tongue Tie 14cm
- Mayo Hegar Needle Holder 14cm.
- Dissecting Forceps 14cm 1x2 Teeth.
- Dressing Forceps 14cm Serrated.
- Dressing Scissor 14cm S/B STR.
- Dressing Scissor 14cm S/B CVD.
- Zipper Case Inside Red Velvet.



### 11-088-004

Set of 10 Pcs.

- Blow Pipe.
- 3PCS Scalpel.
- Dissecting Forceps 14cm.
- Grooved Director With Tongue Tie 14cm
- Triple Chain Hook.
- Dressing Scissor Probe Pointed 14cm.
- Probe Double 14 cm.
- Zipper Case Inside Red Velvet.



### DISSECTING SET

11-089-005 Containing 9 Instruments

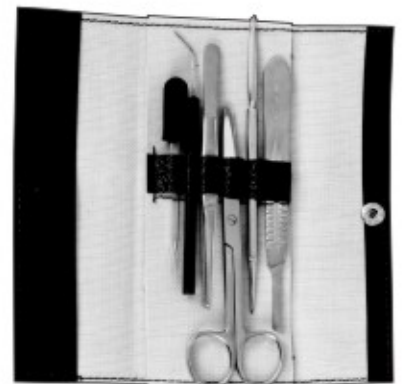

### 11-090-006

Set of 6 pcs.

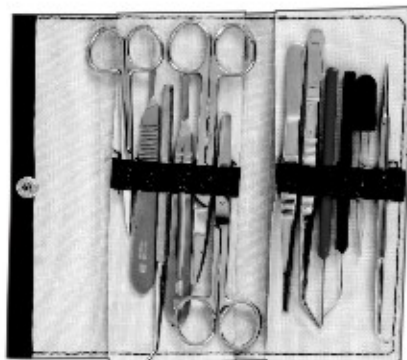

### 11-091-007

Set of 12 pcs.



### DISSECTING KET

11-092-008

Set of 2 pcs.



## CALIPERS, DYNAMOMETERS, FLEXOMETER

Schieblehren, Dynamometer, Winkelmesser  
Calipers, Dinamómetros, Goniómetro

Pieds à Coulisse, Dynamomètres, Goniomètres  
Calibro, Dinamometro, Goniometro



### GRADUATED TAPE MEASURER

11-093-001  
2 m long (1.5 m) graduated  
in inch & cm markings



11-094-150  
15 cm, 6"  
cm & mm  
markings

### GRADUATED METAL RULER



JAMESON  
11-095-001



TOWNLEY  
11-096-115  
11.5 cm, 4 1/4"



MÖLTGEN  
11-097-001



CARROLL  
11-098-145  
14.5 cm, 5 3/4"



CALIPER  
11-099-150  
15.0 cm, 6"

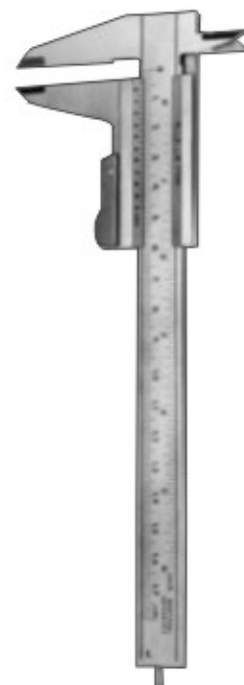

VERNIER  
11-100-120  
12 cm, 5"



**CASTROVIEJO-EPKER**  
11-101-090  
9 cm, 3 1/2"  
Measuring range  
40 mm



**CASTROVIEJO-EPKER**  
11-102-180  
18 cm, 7"  
Measuring range  
40 mm, straight



**CASTROVIEJO-EPKER**  
11-103-180  
18 cm, 7"  
Measuring range  
40 mm, curved



**CASTROVIEJO**  
11-104-080  
8 cm, 3"  
Measuring range  
15 mm



**CASTROVIEJO**  
11-105-080  
8 cm, 3"  
Measuring range  
20 mm



**CASTROVIEJO**  
11-106-080  
8 cm, 3"  
Measuring range  
20 mm



## SUCTION TUBES

Sauger, Saugrohre  
Tubos de aspiración

Tubos d aspiracion  
Tubi d aspirazion

Ø 1.5 mm



**COUPLAND**  
11-107-001

Ø 2.0 mm



**BYRD**  
11-108-01 1.5 mm  
11-109-02 2.5 mm  
11-110-03 3.5 mm

Ø 8.0 mm



**COOLEY**  
11-111-330  
33.0 cm, 13"



**MILLIN'S SUCTION TUBE**  
11-112-001  
chromium-plated,  
with sliding "on & off"  
action.

Ø 8.0 mm



**COOLEY**  
11-113-350  
35 cm, 13 3/4"

Ø 6.0 mm

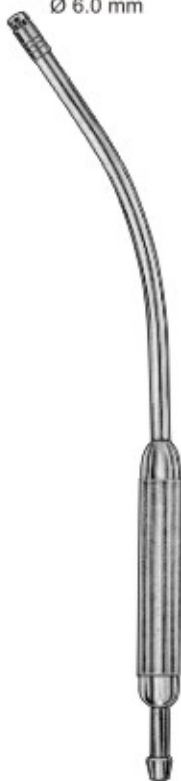

**COOLEY**  
11-114-300  
30.0 cm, 12"

Ø 10.0 mm



**COOLEY**  
11-115-310  
31.0 cm, 12 1/4"

# SUCTION TUBES

Sauger, Saugrohre  
Tubos de aspiración

Tubos d aspiracion  
Tubi d aspirazion

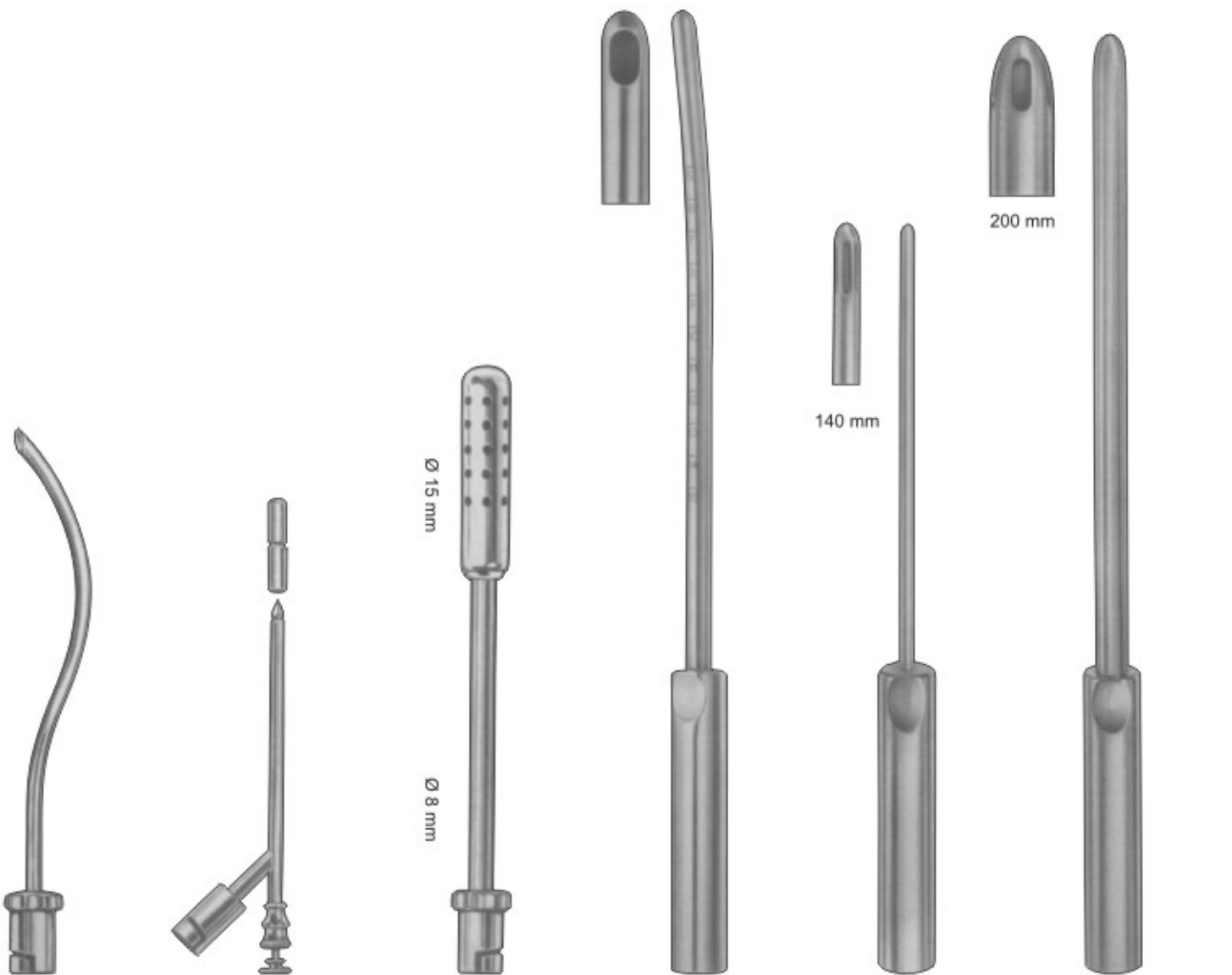

**11-116-170**  
17 cm, 6 1/4"  
For aspirating  
fluid from the excretory  
ducts of large glands  
and for keeping the  
operating area clear

**11-117-150**  
15 cm, 6"  
For aspirating  
fluid from the excretory  
ducts of large glands  
and for keeping the  
operating area clear

**11-118-190**  
19 cm, 8 1/4"  
For aspirating  
fluid from the excretory  
ducts of large glands  
and for keeping the  
operating area clear

**BIEMER**  
**11-119-004** Ø 4 mm  
**11-120-006** Ø 6 mm  
**11-121-008** Ø 8 mm  
**11-122-010** Ø 10 mm  
**11-123-012** Ø 12 mm  
**11-124-014** Ø 14 mm  
Curettes for aspiration  
lipectomy, graduated,  
slightly curved

**BIEMER**  
**11-125-004** Ø 4 mm  
**11-126-006** Ø 6 mm  
Curettes for aspiration  
lipectomy, with three  
apertures, slightly curved  
malleable

**BIEMER**  
**11-127-008** Ø 8 mm  
**11-128-010** Ø 10 mm  
**11-129-012** Ø 12 mm  
Curettes for aspiration  
lipectomy, with three  
apertures, slightly curved  
malleable





## SUCTION TUBES

Sauger, Saugrohre  
Tubos de aspiración

Tubos d aspiracion  
Tubi d aspirazion



**11-130-230**  
23 cm, 9"  
double curved  
for general  
surgery

**11-131-190**  
19 cm, 8 ¼"  
double curved  
for general  
surgery

**11-132-220**  
22 cm, 8 ¼"  
double curved  
for general  
surgery

**TROCAR**  
**11-133-170**  
17 cm, 6 ¼"  
For puncturing

**HOLLOW NEEDLE**  
**11-134-150**  
15 cm, 6"  
sharp

# SUCTION TUBES



Sauger, Saugrohre  
Tubos de aspiración

Tubos d aspiracion  
Tubi d aspirazion



**POOL**  
**11-135-225**  
22.5 cm, 9"  
Suction cannula  
with outer tube  
to be screwed

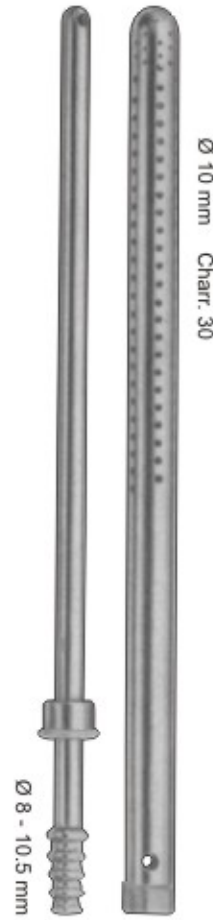

**POOL**  
**11-136-225**  
22.5 cm, 9"  
Suction cannula  
with outer tube  
to be screwed



**11-137-180**  
18 cm, 7"  
for tonsillectomy,  
oral and laryngeal  
operations



**11-138-220**  
22 cm, 8 1/2"  
suction cannula  
for tonsillectomy,  
oral and laryngeal  
operations

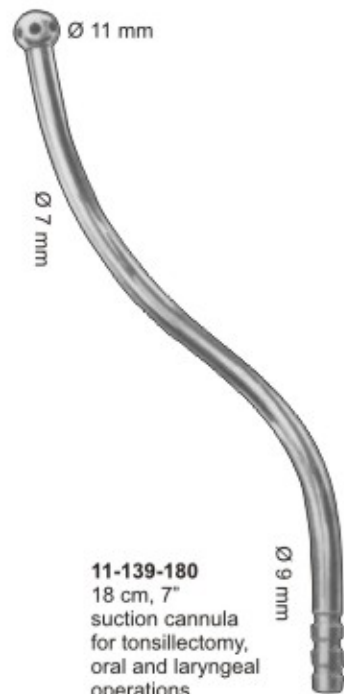

**11-139-180**  
18 cm, 7"  
suction cannula  
for tonsillectomy,  
oral and laryngeal  
operations



**11-140-170**  
17 cm, 6 3/4"  
S-shaped blunt cannula  
for aspirating fluid from  
the excretory ducts of  
large glands and for  
keeping the operations  
area clear



## SUCTION TUBES

Sauger, Saugrohre  
Tubos de aspiración

Tubos d aspiracion  
Tubi d aspirazion



# SUCTION TUBES



Sauger, Saugrohre  
Tubos de aspiración

Tubos d aspiracion  
Tubi d aspirazion



**ADSON**  
11-147-150 4 mm Ø  
15 cm, 6"



**ADSON**  
11-148-150 4 mm Ø, 15 cm, 6"  
11-149-200 4 mm Ø, 20 cm, 8"  
11-150-200 5 mm Ø, 20 cm, 8"

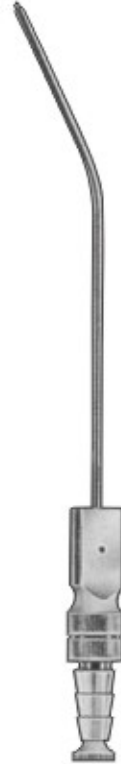

**PLESTER**  
11-151-01 1.5 mm Ø  
11-152-02 2.0 mm Ø  
11-153-03 2.5 mm Ø  
11-154-04 3.0 mm Ø



**FRAZIER-FERGUSON**  
11-155-114 6 Fr.  
11-156-114 7 Fr.  
11-157-114 9 Fr.  
11-158-114 10 Fr.  
11-159-114 11 Fr.  
11.4 cm, 4 1/2"



**FRAZIER**  
11-160-190 6 Fr.  
11-161-190 7 Fr.  
11-162-190 9 Fr.  
11-163-190 11 Fr.  
19 cm, 7 1/2"



**FRAZIER 30°**  
11-164-180 6 Fr.  
11-165-180 7 Fr.  
11-166-180 8 Fr.  
11-167-180 9 Fr.  
11-168-180 10 Fr.  
11-169-180 11 Fr.  
11-170-180 12 Fr.  
11-171-180 15 Fr.  
18 cm, 7"

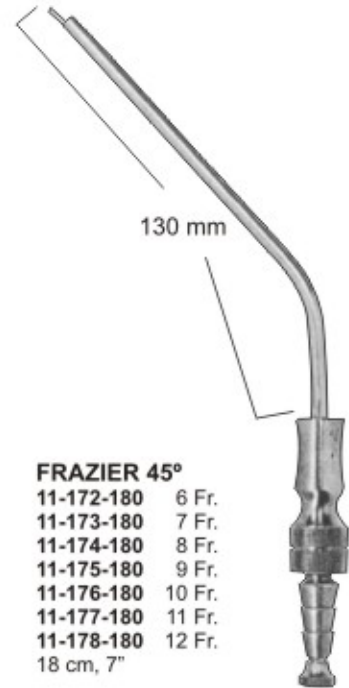

**FRAZIER 45°**  
11-172-180 6 Fr.  
11-173-180 7 Fr.  
11-174-180 8 Fr.  
11-175-180 9 Fr.  
11-176-180 10 Fr.  
11-177-180 11 Fr.  
11-178-180 12 Fr.  
18 cm, 7"



# SUCTION TUBES

Sauger, Saugrohre  
Tubos de aspiración

Tubos d aspiracion  
Tubi d aspirazion



**11-179-175** Ø 4.5 mm  
**11-180-175** Ø 5.5 mm  
17.5 cm, 7"  
Nasal suction tubes



**GORNEY**  
**11-181-180**  
18 cm, 7"  
suction dissector



**11-182-200** 4 mm wide  
**11-183-200** 5 mm wide  
20 cm, 8"  
suction raspatories, sharp,  
bayonet-shaped, with styelt



**LOPEZ-REINKE**  
**11-184-235**  
23.5 cm, 9"  
tonsil dissector with  
suction device



**PLESTER**  
19.5 cm, 8"  
with finger cut-off and  
stylet, thumb piece  
parallel to curved, with  
Luer hub



**FERGUSON**  
18 cm, 7"  
with finger cut-off and  
stylet, thumb piece  
90° to curved, with  
Luer hub



**FERGUSON**  
**11-194-180** Ø 4.0 mm  
18 cm, 7"  
insulated, with finger  
cut-off and stylet, thumb  
piece 90° to curved, with  
Luer hub



**FRAZIER**  
**11-195-180** Ø 3.0 mm  
**11-196-180** Ø 5.0 mm  
18 cm, 7"  
insulated, with finger  
cut-off and stylet, thumb  
piece 90° to curved, with  
Luer hub



**11-197-180**  
18 cm, 7"  
Ø 5.0 mm diam., Tip  
6.5 mm wide nasal  
section tube, with  
luer hub

# TROCARS / SUCTION TUBES



Trokare, Saugrohre  
Trócares, Tubos de aspiración

Trocarts, Tubos d aspiracion  
Trequarti, Tubi d aspirazion

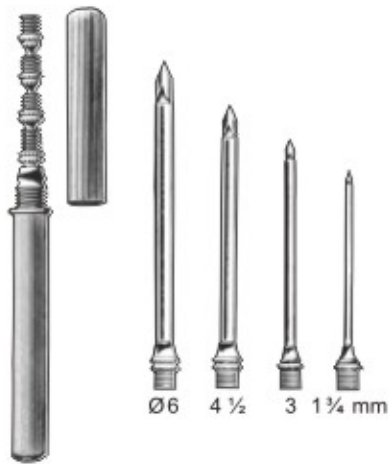

**UNIVERSAL**  
11-198-01  
Set of 3 Pieces  
11-199-02  
Set of 4 Pieces

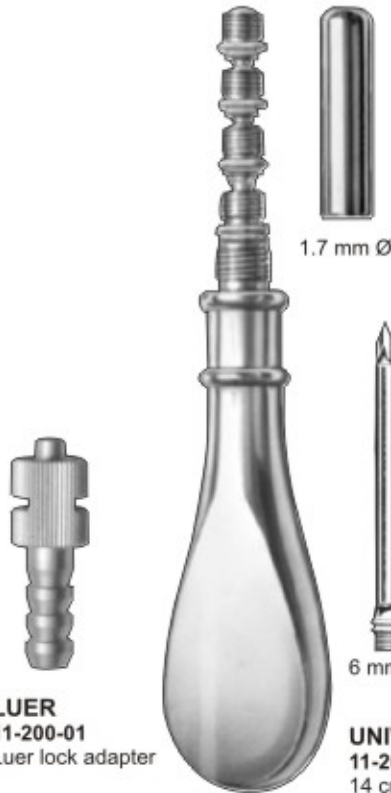

**LUER**  
11-200-01  
Luer lock adapter

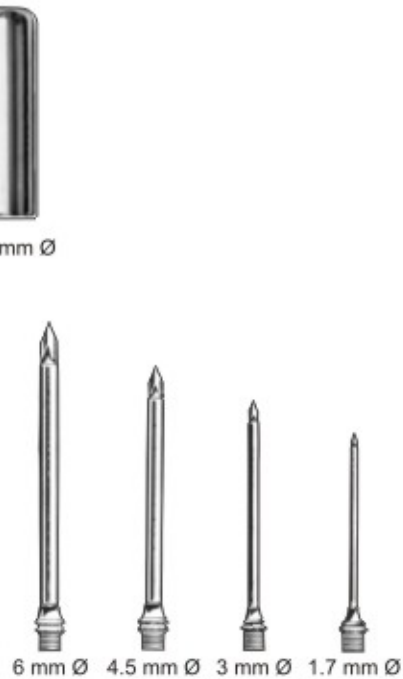

**UNIVERSAL**  
11-201-140  
14 cm, 5 1/2"



**LICHTWITZ**  
11-202-185  
18.5 cm, 7 1/4"  
antrum trocar

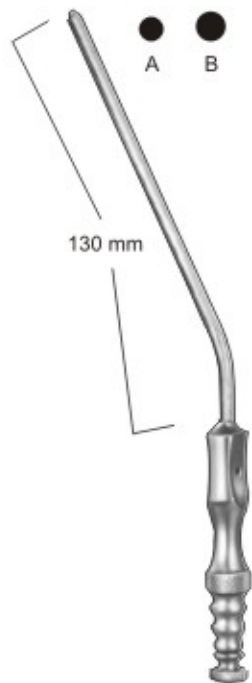

**FRAZIER**



**YANKAUER**  
11-205-270  
27 cm, 10 3/4"

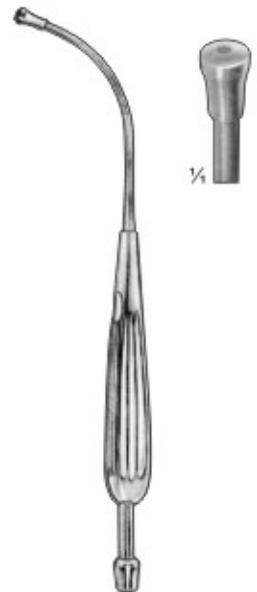

**ANDREWS-PYNCHON**  
11-206-235  
23.5 cm, 9 1/4"

Fig.	Item	Description	W.L	Tip
A	11-203-180	(18 cm, 7") Angled-75°	4.75"	10 French
B	11-204-180	(18 cm, 7") Angled-75°	4.75"	12 French



# TROCARS

Trokare  
Trócares

Trocarts  
Trequarti



## STANDARD

18.5 cm, 7 1/4"

With stopcock and drain

- 11-207-185 3 mm x 80 mm
- 11-208-185 4 mm x 80 mm
- 11-209-185 5 mm x 80 mm
- 11-210-185 6 mm x 80 mm



## STANDARD

18.5 cm, 7 1/4"

With Stopcock

- 11-211-185 3 mm x 80 mm
- 11-212-185 4 mm x 80 mm
- 11-213-185 5 mm x 80 mm
- 11-214-185 6 mm x 80 mm



## NELSON

Abdominal Trocars

- 11-215-170 3.0 mm x 80 mm 17.0 cm, 6 3/4"
- 11-216-170 4.0 mm x 80 mm 17.0 cm, 6 3/4"
- 11-217-170 5.0 mm x 80 mm 17.0 cm, 6 3/4"
- 11-218-170 6.0 mm x 80 mm 17.0 cm, 6 3/4"
- 11-219-210 7.5 mm x 110 mm 21.0 cm, 8 1/4"
- 11-220-210 9.5 mm x 110 mm 21.0 cm, 8 1/4"
- 11-221-210 11.0 mm x 110 mm 21.0 cm, 8 1/4"



## BUELAU

- 11-222-240 8 mm
- 24.0 cm, 9 1/2"



## FLEURANT

- 11-223-230
- 23 cm, 9"
- 5 mm Ø



## FLEURANT

- 11-224-230
- 23 cm, 9"
- 5 mm Ø



## FLEURANT

- 11-225-230
- 23 cm, 9"
- 5 mm Ø



## DOUGLAS

- 11-226-03
- 3 mm Ø



## 11-227-110

- 11 cm, 4 1/2"



**OCHSNER**  
Gall Bladder Trocars  
11-228-140 4.0 mm x 100 mm  
11-229-140 5.5 mm x 100 mm  
11-230-140 6.5 mm x 100 mm  
14.0 cm, 5 1/2"



**LICHTWITZ**  
Antrum Trocars  
11-231-001  
1.8 mm



**PIERCE**  
11-232-004  
4.0 mm



**KRAUSE**  
11-233-005  
5.5 mm



**KRAUSE**  
11-234-005  
5.5 mm



**COAKLEY**  
11-235-002  
2.25 mm



**LANDAU**  
11-236-002  
2.0 mm



**VOGEL**  
Dilatation Forceps  
11-237-265  
26.5 cm, 10 1/2"



**DUKE**  
11-238-110  
11 cm, 4 1/4"  
5.5 mm



**BIRCH**  
11-239-180  
18 cm, 7"  
4.5 mm



**NELSON**  
21 cm, 8 1/4"



1/4  
11-240-210  
21 cm, 8 1/4"



1/4  
11-241-210  
21 cm, 8 1/4"



1/4  
11-242-210  
21 cm, 8 1/4"



1/4  
11-243-210  
21 cm, 8 1/4"





# SUCTION TUBES

Sauger, Saugrohre  
Tubos de aspiración

Tubos d aspiracion  
Tubi d aspirazion

Ø 1.75 mm

## WULLSTEIN

**11-244-160**

16 cm, 5 3/4"

Suction tube, conical, silver, oliver  
with LUER hub

## WULLSTEIN

**11-245-160** Ø 1.5 mm

**11-246-160** Ø 2.0 mm

16 cm, 5 3/4"

Suction tube, cylindrical, silver, with  
stylet with LUER hub

Usable length

**YASARGIL** usable length diam.

**11-247-130** 13 cm, 5" 1.5 mm

**11-248-150** 15 cm, 6" 1.5 mm

**11-249-180** 18 cm, 7" 1.5 mm

**11-250-220** 22 cm, 8 3/4" 1.5 mm

**11-251-130** 13 cm, 5" 2.0 mm

**11-252-150** 15 cm, 6" 2.0 mm

**11-253-180** 18 cm, 7" 2.0 mm

**11-254-220** 22 cm, 8 3/4" 2.0 mm

**YASARGIL** usable length diam.

**11-255-130** 13 cm, 5" 2.5 mm

**11-256-150** 15 cm, 6" 2.5 mm

**11-257-180** 18 cm, 7" 2.5 mm

**11-258-220** 22 cm, 8 3/4" 2.5 mm

**11-259-130** 13 cm, 5" 3.5 mm

**11-260-150** 15 cm, 6" 3.5 mm

**11-261-180** 18 cm, 7" 3.5 mm

**11-262-220** 22 cm, 8 3/4" 3.5 mm

**11-263-180** 18 cm, 7" 4.5 mm

Ø 6.5-9 mm  
with LUER hub

## LANDOLT

**11-264-150**

15 cm, 6"

diam Ø 3mm

**11-265-008** 08 mm / curved

**11-266-011** 11 mm / curved

**11-267-015** 15 mm / curved

Ø 3.5 mm

**11-268-350** 35 cm, 14"

**11-269-500** 50 cm, 20"

with rubber tip,  
with LUER hub

Ø 2.0 mm

**11-270-250** Ø 2.0 mm

**11-271-250** Ø 2.5 mm

**11-272-250** Ø 3.0 mm

25 cm, 10"  
with finger cut-off  
thumb piece 90 to  
curved, with luer hub

Ø 9 mm

Ø 6-9 mm

# SUCTION TUBES



Sauger, Saugrohre  
Tubos de aspiración

Tubos d aspiracion  
Tubi d aspirazion



**FINSTERER**  
11-273-320  
32 cm, 12 3/4"

Ø 9-13 mm

Ø 15 mm

Ø 2 mm

Ø 4.5 mm



**YASARGIL**  
LURE-LOCK Cone  
11-274-200  
20 cm, 8"

Ø 2.5 mm

175 mm

**11-275-175**  
17.5 cm, 6 1/2"  
with finger cut-off and stylet,

4.5 mm

90 mm

**HOUSE**  
11-276-001

Suction tube diam.  
irrigationtube diam.

**11-277-001** 0.9 mm 0.7 mm

**11-278-002** 1.2 mm 0.9 mm

**11-279-003** 1.5 mm 1.2 mm

with finger cut-off and stylet,  
with lure hub

4 mm

Ø 9-6 mm

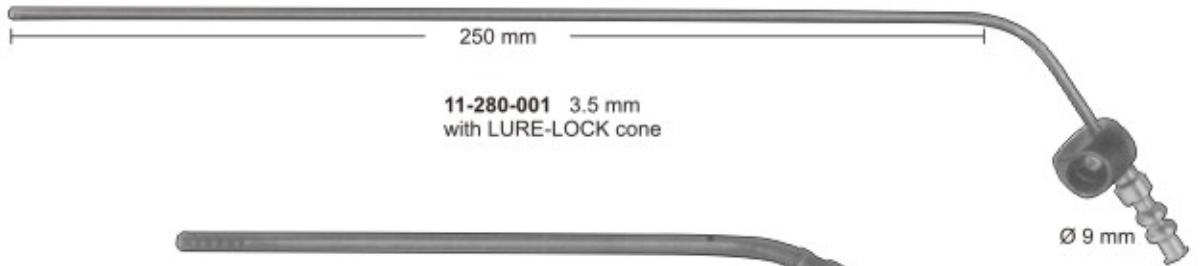

**11-280-001** 3.5 mm  
with LURE-LOCK cone

Ø 9 mm

**LANDOLT**  
11-281-001

With finger cut-off and  
stylet, can be sterilized  
in an autoclave up to 3 bar (143 c)

Connection for  
suction hose

Ø 7.5-12 mm

4 mm diam., Untrashed  
contact to be touched by  
HF-electrodes



# SCALPEL HOLDERS, AMPUTATION KNIVES & SAWS

---

- **SCALPEL HOLDERS**
- **DISSECTING KNIVES**

- **AMPUTATION KNIVES**
- **SAWS**

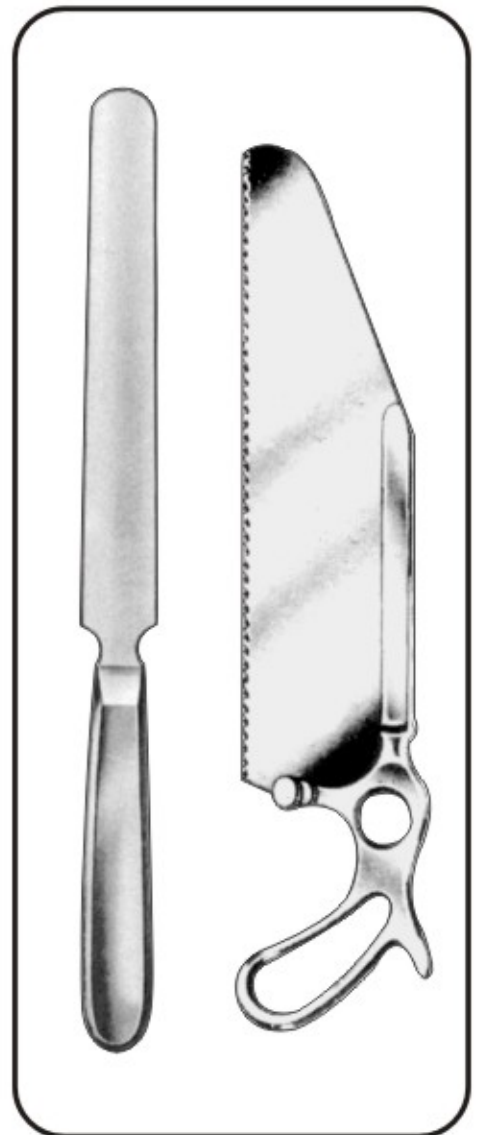
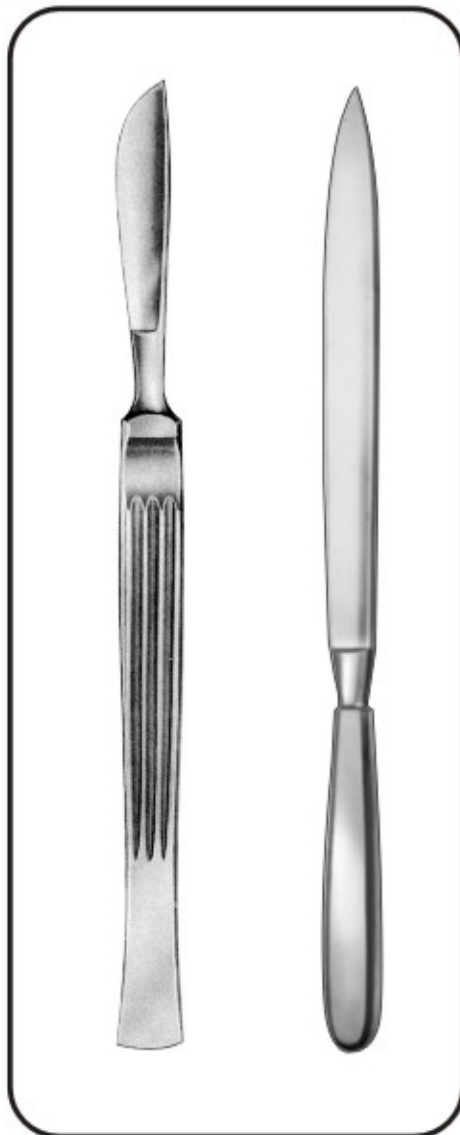

# SCALPEL HANDLES

Skalpgriffe  
Mangos de bisturíes

Manches pour bistouris  
Manici per bisturi

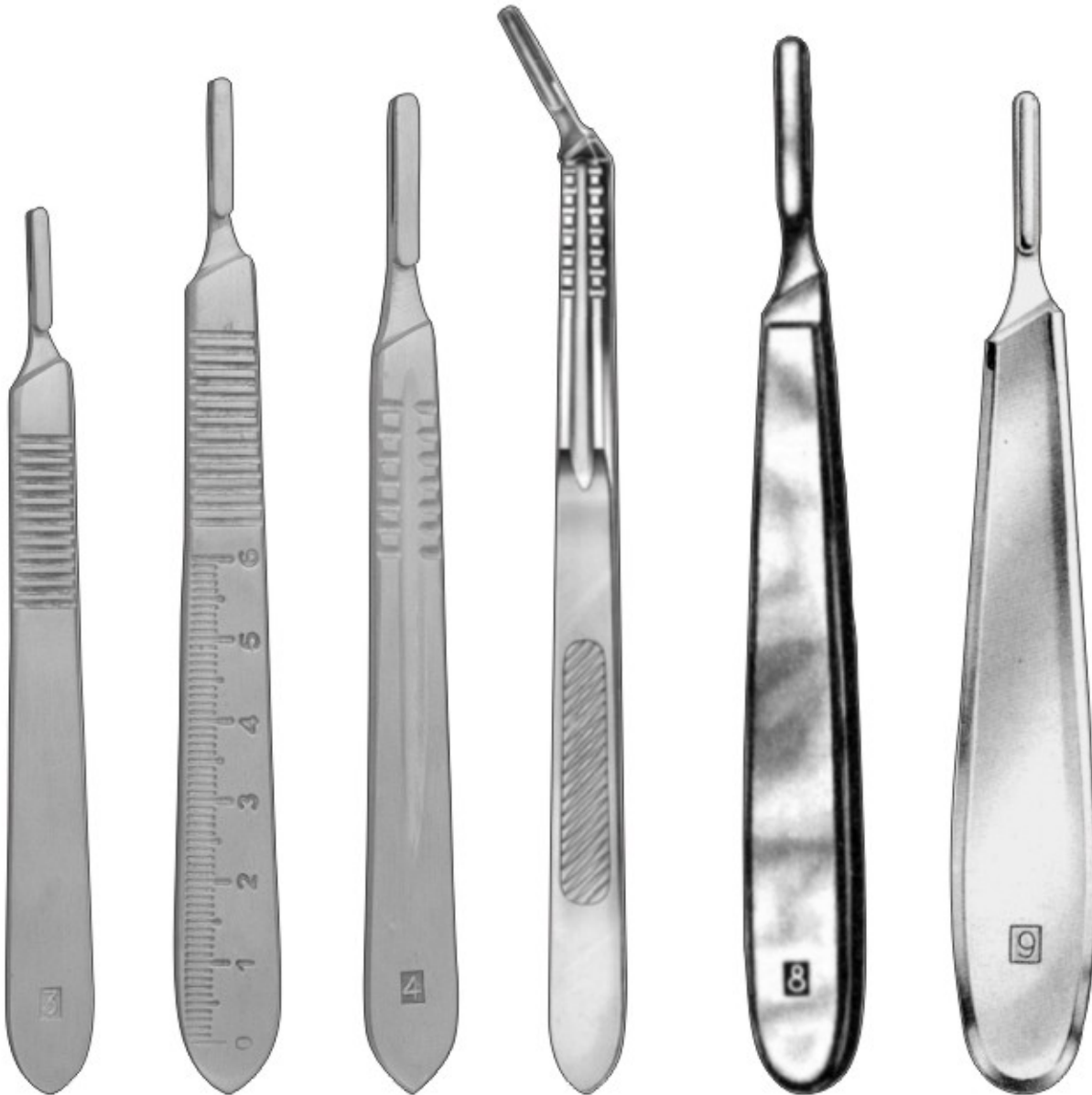

Fig. 10 Fig. 11

Blade Sizes



Fig. 12 Fig. 15



Fig. 20 Fig. 22

**#3 SCALPEL  
HANDLE**  
13-001-120  
12.75 cm, 5"  
Blade Size  
10, 11, 12, 15

**#3 SCALPEL  
HANDLE/  
GRADUATED**  
13-002-120  
12.75 cm, 5"  
Blade Size  
10, 11, 12, 15

**#4 SCALPEL  
HANDLE**  
13-003-120  
12.75 cm, 5"  
Blade Size  
20, 22, 25

**4L SCALPEL  
HANDLE**  
13-004-210  
21 cm, 8 1/4"

**SCALPEL PLASTIC  
HANDLE**  
13-005-08  
# 8

**COLLIN**  
13-006-09  
# 9



## SCALPEL HANDLES

Skalpgriffe  
Mangos de bisturíes

Manches pour bistouris  
Manici per bisturi

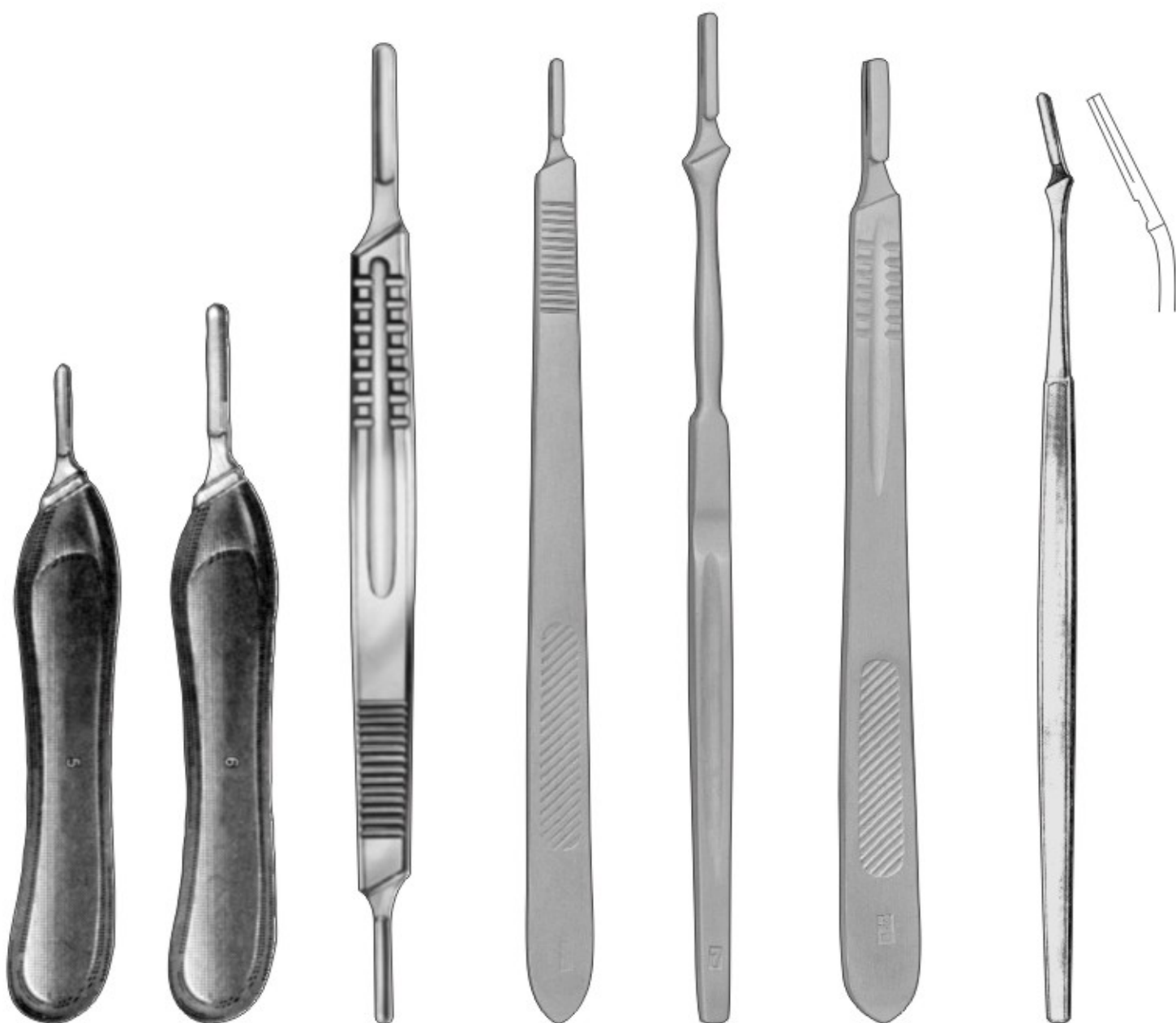

**SCALPEL  
PLASTIC  
HANDLE**  
13-007-05  
# 5

**SCALPEL  
PLASTIC  
HANDLE**  
13-008-06  
# 6

**#3, #4 SCALPEL  
HANDLE**  
13-009-160  
16 cm, 6"

**SCALPEL  
HANDLE  
3L LONG**  
13-010-120  
21 cm, 8 1/4"  
Blade Size  
10, 11, 12, 15

**#7 SCALPEL  
HANDLE**  
13-011-160  
16.5 cm, 6 1/4"  
Blade  
10, 11, 12, 15

**SCALPEL  
HANDLE  
4L long**  
13-012-210  
21 cm, 8 1/4"

**#3 SCALPEL HANDLE /  
LONG ANGLED**  
13-013-200  
20.25 cm, 8 1/4"  
Blade Size  
10, 11, 12, 15

# SCALPEL HANDLES

Skalpellgriffe  
Mangos de bisturís

Manches pour bistouris  
Manici per bisturi



**SCALPEL  
HANDLE**  
13-014-160  
16 cm, 6 1/4"



**SCALPEL  
HANDLE**  
13-015-115  
11.5 cm, 4 1/2"



**SCALPEL  
HANDLE**  
13-016-127  
12.7 cm, 5"



**SCALPEL  
HANDLE**  
13-017-127  
12.7 cm, 5"



**SCALPEL  
HANDLE**  
13-018-110  
11 cm, 4 1/4"



**SCALPEL  
HANDLE**  
13-019-135  
13.5 cm, 5 1/4"



**SCALPEL  
HANDLE**  
13-020-120  
12 cm, 4 3/4"



## SCALPEL HANDLES

Skalpgriffe  
Mangos de bisturíes

Manches pour bistouris  
Manici per bisturi



**KAYE**  
13-021-150  
15 cm, 5 1/4"



**CORWIN ROUND**  
13-022-145  
14.5 cm, 5 1/2"  
Blade Size  
10, 11, 12, 15



**SCALPEL HANDLE**  
13-023-140  
14 cm, 5 1/2"



**SCALPEL HANDLE**  
13-024-155  
15.5 cm, 6"



**TROUTMAN-CHRIS**  
13-025-090  
9 cm, 3 1/2"



**TROUTMAN-CHRIS**  
13-026-090  
9 cm, 3 1/2"



**BLADE HOLDER  
BLADE BREAKER**  
13-027-110  
11 cm, 4 1/4"



**CASTROVIEJO**  
13-028-130  
13 cm, 5 1/4"

# DISSECTING KNIVES



Anatomische skalpelle  
Bisturías para disección

Bistouris à dissection  
Bisturi para dissezione



**DIEFFENBACH**  
16 cm, 6 1/4"



Fig. 1  
13-029-160  
16 cm, 6 1/4"



Fig. 2  
13-030-160  
16 cm, 6 1/4"



Fig. 3  
13-031-160  
16 cm, 6 1/4"



Fig. 4  
13-032-160  
16 cm, 6 1/4"



Fig. 5  
13-033-160  
16 cm, 6 1/4"



Fig. 6  
13-034-160  
16 cm, 6 1/4"



Fig. 7  
13-035-160  
16 cm, 6 1/4"



Fig. 8  
13-036-160  
16 cm, 6 1/4"



Fig. 9  
13-037-160  
16 cm, 6 1/4"



Fig. 15  
13-038-160  
16 cm, 6 1/4"



Fig. 16  
13-039-160  
16 cm, 6 1/4"





# DISSECTING KNIVES

Anatomische skalpelle  
Bisturías para disección

Bistouris à dissection  
Bisturi para dissezione



**COLLIN**  
14.5 cm, 5 3/4"



Fig. 1  
**13-040-145**  
14.5 cm, 5 3/4"



Fig. 2  
**13-041-145**  
14.5 cm, 5 3/4"



Fig. 3  
**13-042-145**  
14.5 cm, 5 3/4"



Fig. 4  
**13-043-145**  
14.5 cm, 5 3/4"



Fig. 5  
**13-044-145**  
14.5 cm, 5 3/4"



Fig. 6  
**13-045-145**  
14.5 cm, 5 3/4"



**DIEFFENBACH**  
13.5 cm



Fig. 1  
**13-046-135**  
13.5 cm, 5 1/4"



Fig. 2  
**13-047-135**  
13.5 cm, 5 1/4"



Fig. 3  
**13-048-135**  
13.5 cm, 5 1/4"



Fig. 4  
**13-049-135**  
13.5 cm, 5 1/4"



Fig. 5  
**13-050-135**  
13.5 cm, 5 1/4"



Fig. 6  
**13-051-135**  
13.5 cm, 5 1/4"



Fig. 7  
**13-052-135**  
13.5 cm, 5 1/4"



Fig. 8  
**13-053-135**  
13.5 cm, 5 1/4"



Fig. 9  
**13-054-135**  
13.5 cm, 5 1/4"



Fig. 10  
**13-055-135**  
13.5 cm, 5 1/4"



17 cm, 6 3/4"



Fig. 1  
13-056-170  
17 cm, 6 3/4"



Fig. 3  
13-057-170  
17 cm, 6 3/4"



Fig. 5  
13-058-170  
17 cm, 6 3/4"



Fig. 7  
13-059-170  
17 cm, 6 3/4"



Fig. 9  
13-060-170  
17 cm, 6 3/4"



Fig. 10  
13-061-170  
17 cm, 6 3/4"



Fig. 12  
13-062-170  
17 cm, 6 3/4"



Fig. 14  
13-063-170  
17 cm, 6 3/4"



Fig. 16  
13-064-170  
17 cm, 6 3/4"



Fig. 18  
13-065-170  
17 cm, 6 3/4"



## DISSECTING KNIVES

Anatomische skalpelle  
Bisturíes para disección

Bistouris à dissection  
Bisturi para dissezione



**DISSECTING KNIFE**  
15 cm, 6"  
with metal handle



**13-066-150**

15 cm, 6"



30 mm



**13-067-150**

15 cm, 6"



36 mm



**13-068-155**

15.5 cm, 6"



40 mm



**13-069-160**

16 cm, 6 1/4"



45 mm



**13-070-160**

16 cm, 6 1/4"



50 mm



**13-071-150**

15 cm, 6"



27 mm



**13-072-150**

15 cm, 6"



35 mm



**13-073-160**

16 cm, 6 1/4"



40 mm



**13-074-160**

16 cm, 6 1/4"



47 mm



**13-075-170**

17 cm, 6 3/4"



50 mm

# DISSECTING KNIVES

Anatomische skalpelle  
Bisturías para disección

Bistouris à dissection  
Bisturi para dissezione



**AYRE**  
13-076-235  
23.5 cm, 9"  
Cone Knife

13-077-230  
23 cm, 9"  
Cone Knife

**SEGOND**  
13-078-270  
27 cm, 11"  
Myotomome

**OLIVECRONA**  
13-079-205  
20.5 cm, 8"  
Trigeminal knife

13-080-230  
23 cm, 9"  
Trigeminal knife

**FOWLER**  
13-081-200  
20 cm, 8"  
Tonsil knife

**ABRAHAM**  
13-082-215  
21.5 cm, 8 1/4"  
Tonsil knife

**BRUNINGS**  
13-083-215  
21.5 cm, 8 1/4"  
Tonsil knife



# DISSECTING KNIVES

Anatomische skalpelle  
Bisturías para disección

Bistouris à dissection  
Bisturi para dissezione



**COLLIN** Blade  
13-084-130 13 cm, 5"  
13-085-160 16 cm, 6 1/4"  
13-086-190 19 cm, 7 1/2"  
13-087-220 22 cm, 8 1/2"  
13-088-280 28 cm, 11 1/4"



**CATLIN** Blade  
13-089-160 16 cm, 6 1/4"  
13-090-190 19 cm, 7 1/2"  
13-091-220 22 cm, 8 1/2"



**LISTON** Blade  
13-092-160 16 cm, 6 1/4"  
13-093-190 19 cm, 7 1/2"  
13-094-220 22 cm, 8 1/2"



**LANGENBECK** Blade  
13-095-120 12 cm, 4 3/4"



**DIEFFENBACH**  
13-096-130  
13 cm, 5"



**DIEFFENBACH**  
13-097-130  
13 cm, 5"



**SIMON**  
13-098-235  
23.5 cm, 9 1/4"



Fig. 1  
13-099-235



Fig. 2  
13-100-235



Fig. 3  
13-101-235



Fig. 4  
13-102-235

# DISSECTING KNIVES

Anatomische skalpelle  
Bisturías para disección

Bistouris à dissection  
Bisturi para dissezione





## AMPUTATION & RESECTION

Amputationsmesser, Cuchillos para amputación  
Couteaux à amputation, coltelli per amputazione

Resektionsmesser, Cuchillos para resección  
Couteaux à résection, Coltelli per resezione



**AMPUTATION KNIFE**  
13-109-290  
29 cm, 11 1/2"



**AMPUTATION KNIFE**  
13-110-325  
32.5 cm, 13"



**CATLIN**  
13-111-290  
29 cm, 11 1/2"



**RESECTION KNIFE**  
13-112-180  
18 cm, 7"



**LANGENBECK**  
13-113-180  
18 cm, 7"



**LANGENBECK**  
13-114-180  
18 cm, 7"



**RAZOR**  
13-115-001  
Hollow Blades On  
Both Sides  
13-116-002  
Blade Flat / Hollow

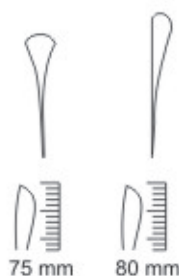

75 mm

80 mm



**CHARRIERE**  
13-117-270 27 cm, 11"  
13-118-300 30 cm, 12"



**CHARRIERE**  
13-119-350  
35 cm, 13 3/4"



**SATTERLEE**  
13-120-310  
31 cm, 12 1/4"

# SCISSORS



- OPERATING SCISSORS
- PLASTER SHEARS

- MICRO SCISSORS
- T.C. SCISSORS

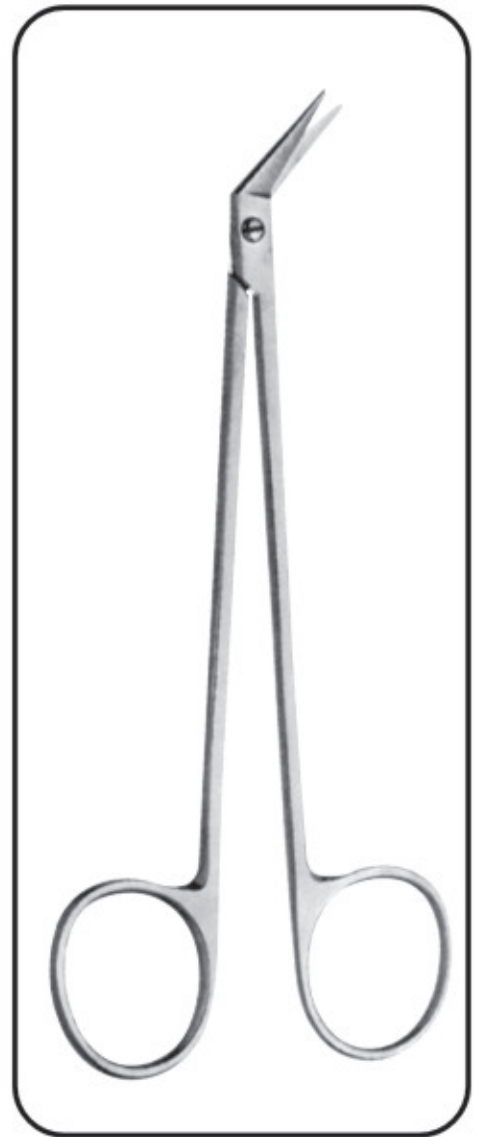
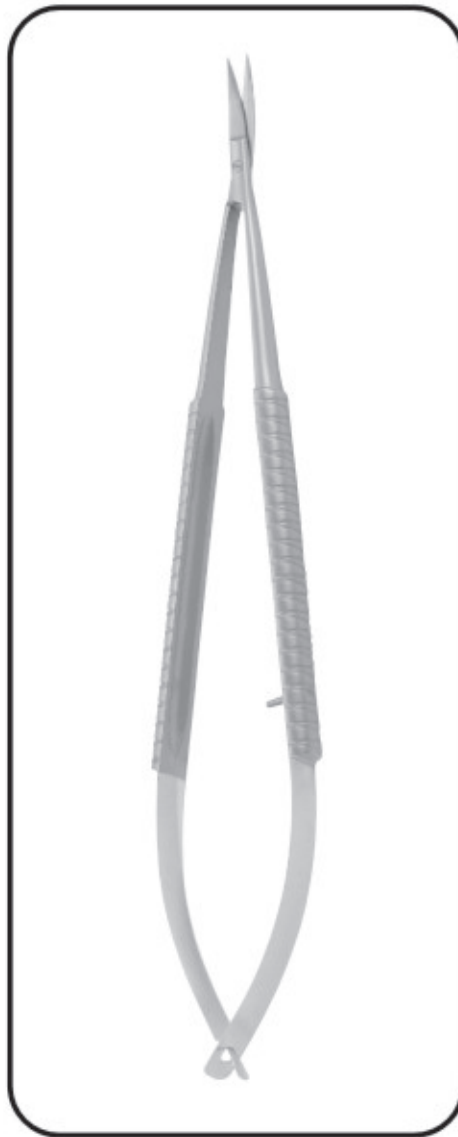





# OPERATING SCISSORS

Chirurgische scheren  
Tijeras quirúrgicas

Ciseaux chirurgicaux  
Forbici per chirurgia

## ROUND PATTERN

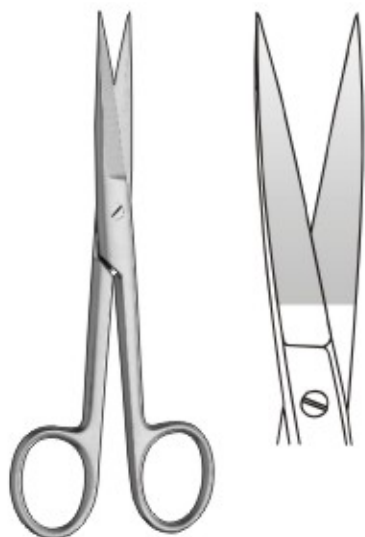

### STANDARD STRAIGHT

15-001-115	11.5 cm, 4 1/2"
15-002-130	13.0 cm, 5"
15-003-140	14.0 cm, 5 1/2"
15-004-150	15.0 cm, 6"
15-005-160	16.0 cm, 6 1/4"
15-006-175	17.5 cm, 7"
15-007-185	18.5 cm, 7 1/4"
15-008-200	20.0 cm, 8"

S/S Str.

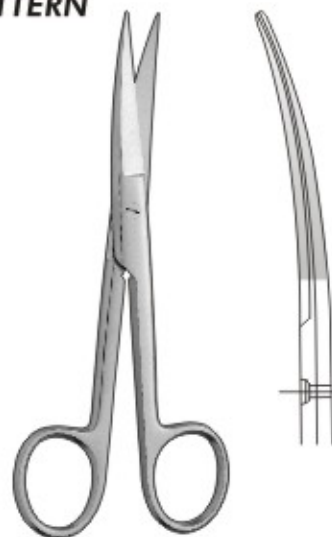

### STANDARD CURVED

15-009-115	11.5 cm, 4 1/2"
15-010-130	13.0 cm, 5"
15-011-140	14.0 cm, 5 1/2"
15-012-150	15.0 cm, 6"
15-013-160	16.0 cm, 6 1/4"
15-014-175	17.5 cm, 7"
15-015-185	18.5 cm, 7 1/4"
15-016-200	20.0 cm, 8"

S/S Cvd.

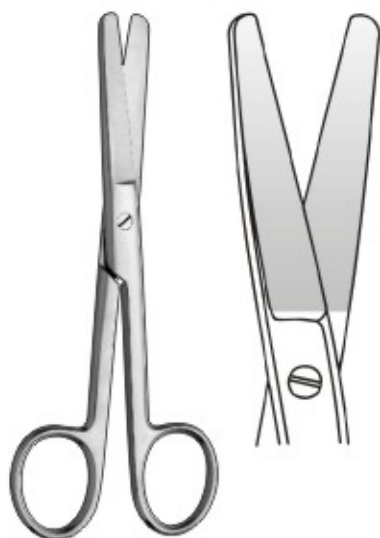

### STANDARD STRAIGHT

15-017-115	11.5 cm, 4 1/2"
15-018-130	13.0 cm, 5"
15-019-140	14.0 cm, 5 1/2"
15-020-150	15.0 cm, 6"
15-021-160	16.0 cm, 6 1/4"
15-022-175	17.5 cm, 7"
15-023-185	18.5 cm, 7 1/4"
15-024-200	20.0 cm, 8"

B/B Str.

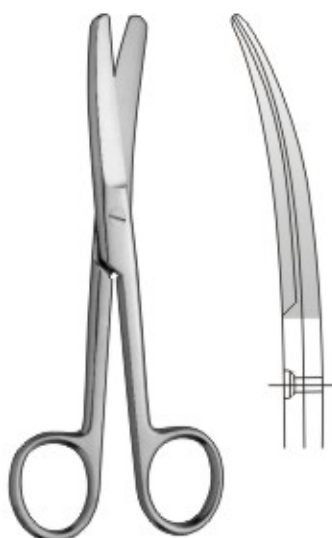

### STANDARD CURVED

15-025-115	11.5 cm, 4 1/2"
15-026-130	13.0 cm, 5"
15-027-140	14.0 cm, 5 1/2"
15-028-150	15.0 cm, 6"
15-029-160	16.0 cm, 6 1/4"
15-030-175	17.5 cm, 7"
15-031-185	18.5 cm, 7 1/4"
15-032-200	20.0 cm, 8"

B/B Cvd.

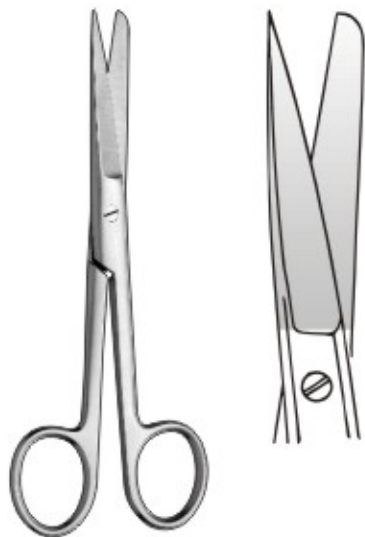

### STANDARD STRAIGHT

15-033-115	11.5 cm, 4 1/2"
15-034-130	13.0 cm, 5"
15-035-140	14.0 cm, 5 1/2"
15-036-150	15.0 cm, 6"
15-037-160	16.0 cm, 6 1/4"
15-038-175	17.5 cm, 7"
15-039-185	18.5 cm, 7 1/4"
15-040-200	20.0 cm, 8"

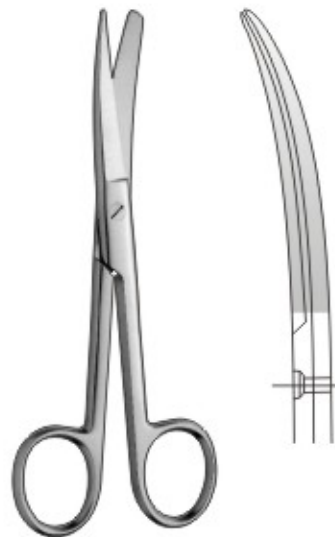

### STANDARD CURVED

15-041-115	11.5 cm, 4 1/2"
15-042-130	13.0 cm, 5"
15-043-140	14.0 cm, 5 1/2"
15-044-150	15.0 cm, 6"
15-045-160	16.0 cm, 6 1/4"
15-046-175	17.5 cm, 7"
15-047-185	18.5 cm, 7 1/4"
15-048-200	20.0 cm, 8"

# OPERATING SCISSORS



Chirurgische scheren  
Tijeras quirúrgicas

Ciseaux chirurgicaux  
Forbici per chirurgia

## FLAT PATTERN

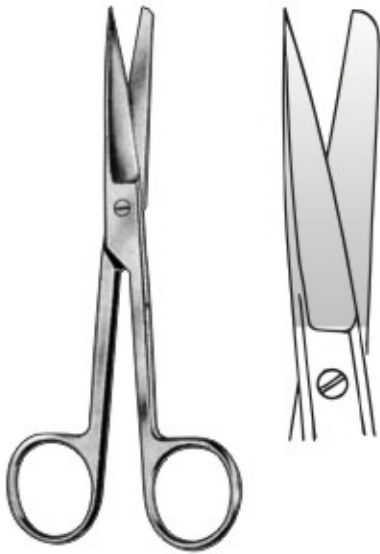

### STANDARD STRAIGHT

15-049-115	11.5 cm, 4 1/2"
15-050-130	13.0 cm, 5"
15-051-140	14.0 cm, 5 1/2"
15-052-150	15.0 cm, 6"
15-053-160	16.0 cm, 6 1/4"
15-054-175	17.5 cm, 7"
15-055-185	18.5 cm, 7 1/4"
15-056-200	20.0 cm, 8"

S/B Str.

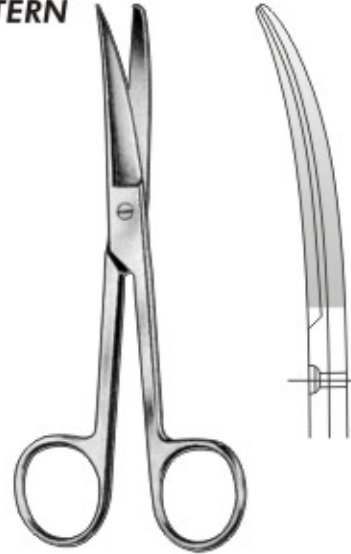

### STANDARD CURVED

15-057-115	11.5 cm, 4 1/2"
15-058-130	13.0 cm, 5"
15-059-140	14.0 cm, 5 1/2"
15-060-150	15.0 cm, 6"
15-061-165	16.0 cm, 6 1/4"
15-062-175	17.5 cm, 7"
15-063-185	18.5 cm, 7 1/4"
15-064-200	20.0 cm, 8"

S/B Cvd.



### STANDARD STRAIGHT

15-065-115	11.5 cm, 4 1/2"
15-066-130	13.0 cm, 5"
15-067-140	14.0 cm, 5 1/2"
15-068-150	15.0 cm, 6"
15-069-160	16.0 cm, 6 1/4"
15-070-175	17.5 cm, 7"
15-071-185	18.5 cm, 7 1/4"
15-072-200	20.0 cm, 8"

S/S Str.



### STANDARD CURVED

15-073-115	11.5 cm, 4 1/2"
15-074-130	13.0 cm, 5"
15-075-140	14.0 cm, 5 1/2"
15-076-150	15.0 cm, 6"
15-077-160	16.0 cm, 6 1/4"
15-078-175	17.5 cm, 7"
15-079-185	18.5 cm, 7 1/4"
15-080-200	20.0 cm, 8"

S/S Cvd.



### STANDARD STRAIGHT

15-081-115	11.5 cm, 4 1/2"
15-082-130	13.0 cm, 5"
15-083-140	14.0 cm, 5 1/2"
15-084-150	15.0 cm, 6"
15-085-160	16.0 cm, 6 1/4"
15-086-175	17.5 cm, 7"
15-087-185	18.5 cm, 7 1/4"
15-088-200	20.0 cm, 8"

B/B Str.



### STANDARD CURVED

15-089-115	11.5 cm, 4 1/2"
15-090-130	13.0 cm, 5"
15-091-140	14.0 cm, 5 1/2"
15-092-150	15.0 cm, 6"
15-093-160	16.0 cm, 6 1/4"
15-094-175	17.5 cm, 7"
15-095-185	18.5 cm, 7 1/4"
15-096-200	20.0 cm, 8"

B/B Cvd.



## OPERATING, DISSECTING SCISSORS

Chirurgische scheren, Präparierscheren  
Tijeras quirúrgicas, Tijeras de disección

Ciseaux chirurgicaux, Ciseaux à dissection  
Forbici per chirurgia, Forbici per dissezione

### FINE PATTERN



**GRAZIL STRAIGHT**  
15-097-130 13.0 cm, 5"  
15-098-145 14.5 cm, 5 ¼"  
S/B Str.



**GRAZIL CURVED**  
15-099-130 13.0 cm, 5"  
15-100-145 14.5 cm, 5 ¼"  
S/B Cvd.



**GRAZIL STRAIGHT**  
15-101-130 13.0 cm, 5"  
15-102-145 14.5 cm, 5 ¼"  
S/S Str.

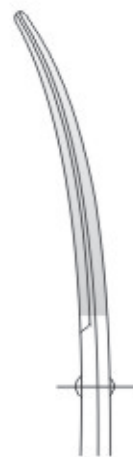

**GRAZIL CURVED**  
15-103-130 13.0 cm, 5"  
15-104-145 14.5 cm, 5 ¼"  
S/S Cvd.



**GRAZIL STRAIGHT**  
15-105-130 13.0 cm, 5"  
15-106-145 14.5 cm, 5 ¼"  
B/B Str.



**GRAZIL CURVED**  
15-107-130 13.0 cm, 5"  
15-108-145 14.5 cm, 5 ¼"  
B/B Cvd.

# OPERATING, DISSECTING SCISSORS

Chirurgische scheren, Präparierscheren  
Tijeras quirúrgicas, Tijeras de disección

Ciseaux chirurgicaux, Ciseaux à dissection  
Forbici per chirurgia, Forbici per dissezione



**DEAVER**  
15-109-140  
14.0 cm, 5 1/2"

**DEAVER**  
15-110-140  
14.0 cm, 5 1/2"

**MIXTER**  
15-111-155  
15.5 cm, 6"

**MIXTER**  
15-112-155  
15.5 cm, 6"

**JORGENSON**  
15-113-220  
22 cm, 8 1/2"  
Curved



**INCISION SCISSORS**  
15-114-130 13.0 cm, 5"  
15-115-145 14.5 cm, 5 1/2"

**INCISION SCISSORS**  
15-116-155  
15.5 cm, 6"

**RICHTER**  
15-117-145  
14.5 cm, 5 1/2"

**FERGUSSON**  
15-118-140 14.0 cm, 5 1/2"  
15-119-165 16.5 cm, 6 1/2"  
15-120-180 18.0 cm, 7"



## DISSECTING & GYNECOLOGICAL SCISSORS

Präparierscheren, Gynäkologische Scheren  
Tijeras de disección, Tijeras para ginecología

Ciseaux à dissection, ciseaux à gynécologie  
Forbici per dissezione, Forbici per ginecologia



**MAYO-STILLE**  
15-121-150 15.0 cm, 6"  
15-122-170 17.0 cm, 6 3/4"  
Str.

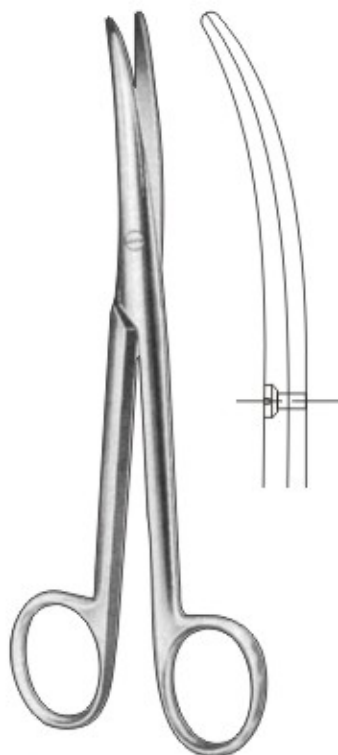

**MAYO-STILLE**  
15-123-150 15.0 cm, 6"  
15-124-170 17.0 cm, 6 3/4"  
Cvd.

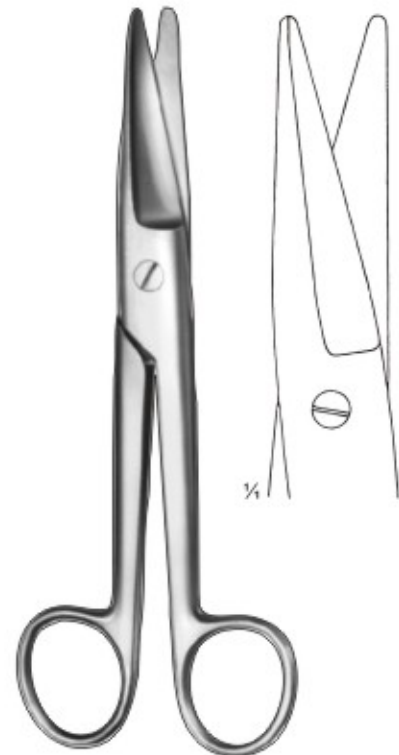

**MAYO-NOBLE**  
15-125-170  
17.0 cm, 6 3/4"  
Str.

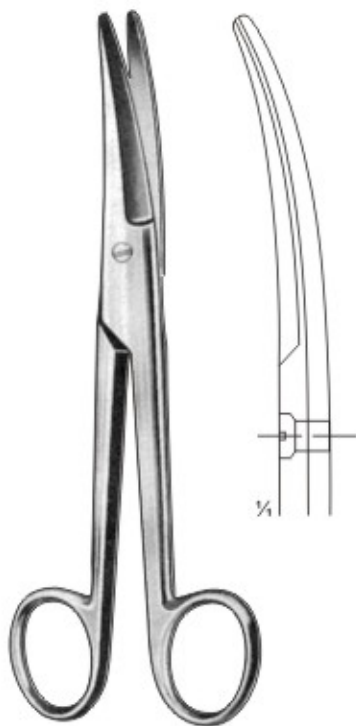

**MAYO-NOBLE**  
15-126-170  
17.0 cm, 6 3/4"  
Cvd.



**MAYO** Str.  
15-127-145 14.5 cm, 5 1/2"  
15-128-150 15.0 cm, 6"  
15-129-170 17.0 cm, 6 3/4"

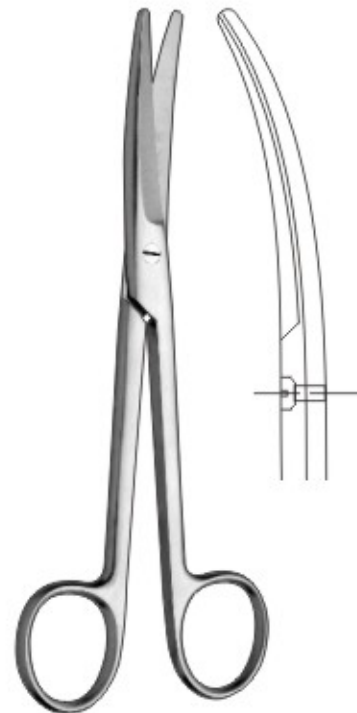

**MAYO** Cvd.  
15-130-145 14.5 cm, 5 1/2"  
15-131-150 15.0 cm, 6"  
15-132-170 17.0 cm, 6 3/4"

# OPERATING, DISSECTING SCISSORS



Chirurgische scheren, Präparierscheren  
Tijeras quirúrgicas, Tijeras de disección

Ciseaux chirurgicaux, Ciseaux à dissection  
Forbici per chirurgia, Forbici per dissezione



**METZENBAUM**  
Blunt / Blunt



**15-133-180**  
14.5 cm, 5 3/4"



**15-134-180**  
18.0 cm, 7"



**15-135-200**  
20.0 cm, 8"



**15-136-230**  
23.0 cm, 9"



**15-137-250**  
25.0 cm, 10"



**15-138-280**  
28.0 cm, 11"



**METZENBAUM**  
Blunt / Blunt



**15-139-145**  
14.5 cm, 5 3/4"



**15-140-180**  
18.0 cm, 7"

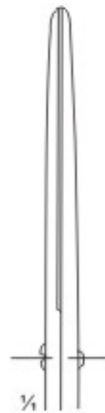

**15-141-200**  
20.0 cm, 8"

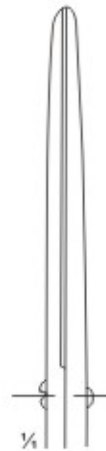

**15-142-230**  
23.0 cm, 9"



**15-143-250**  
25.0 cm, 10"



**15-144-280**  
28.0 cm, 11"



# DISSECTING SCISSORS

Präparierscheren  
Tijeras de disección

Ciseaux à dissection  
Forbici per dissezione

Blade length  
6.4 cm  
5.1 cm  
4.4 cm



## METZENBAUM DISSECTING

15-145-203 20.3 cm, 8"  
15-146-229 22.9 cm, 9"  
15-147-284 28.4 cm, 11"

Curved



## METZENBAUM-JAMISON

15-148-152  
15.25 cm, 6"



## METZENBAUM-BABY

15-149-115  
11.5 cm, 4 1/2"

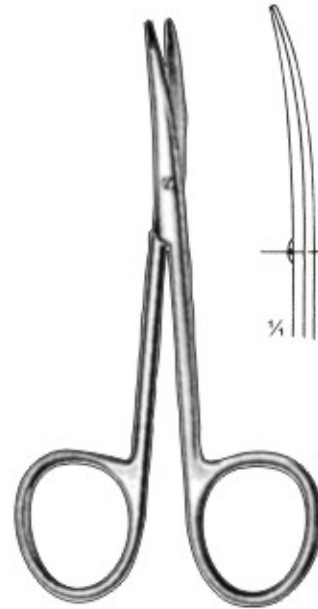

## METZENBAUM-BABY

15-150-115  
11.5 cm, 4 1/2"

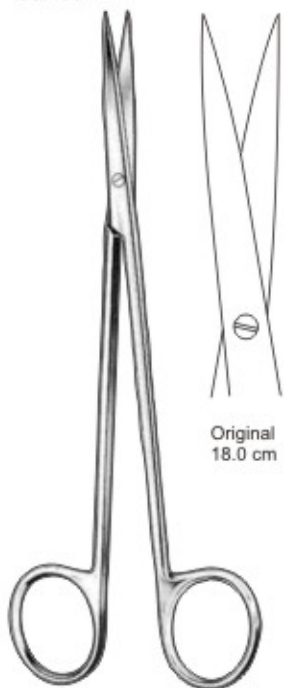

Original  
18.0 cm

## METZENBAUM Sharp/Sharp, Str.

15-151-145 14.5 cm, 5 1/2"  
15-152-180 18.0 cm, 7"  
15-153-200 20.0 cm, 8"  
15-154-230 23.0 cm, 9"  
15-155-250 25.0 cm, 10"  
15-156-280 28.0 cm, 11"  
15-157-300 30.0 cm, 12"

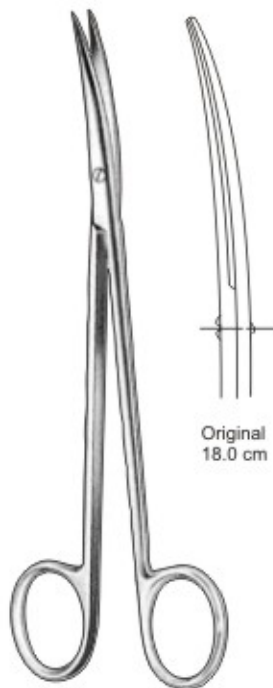

Original  
18.0 cm

## METZENBAUM Sharp/Sharp, Cvd.

15-158-145 14.5 cm, 5 1/2"  
15-159-180 18.0 cm, 7"  
15-160-200 20.0 cm, 8"  
15-161-230 23.0 cm, 9"  
15-162-250 25.0 cm, 10"  
15-163-280 28.0 cm, 11"  
15-164-300 30.0 cm, 12"



## METZENBAUM Sharp/Blunt, Str.

15-165-145 14.5 cm, 5 1/2"  
15-166-180 18.0 cm, 7"  
15-167-200 20.0 cm, 8"  
15-168-230 23.0 cm, 9"  
15-169-250 25.0 cm, 10"  
15-170-280 28.0 cm, 11"  
15-171-300 30.0 cm, 12"

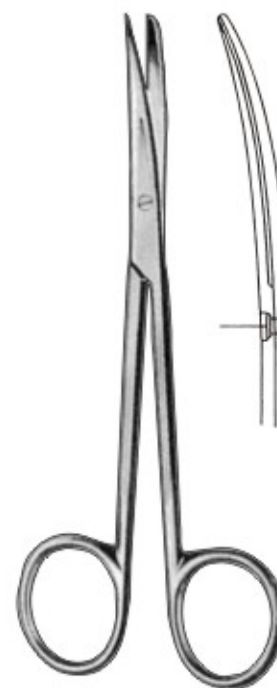

## METZENBAUM Sharp/Blunt, Cvd.

15-172-145 14.5 cm, 5 1/2"  
15-173-180 18.0 cm, 7"  
15-174-200 20.0 cm, 8"  
15-175-230 23.0 cm, 9"  
15-176-250 25.0 cm, 10"  
15-177-280 28.0 cm, 11"  
15-178-300 30.0 cm, 12"

# FACE-LIFE, DISSECTING, NASAL SCISSORS



Face-lift , Präparierscheren, Nasenscheren  
face-Lift, Tijeras de disección, Tijeras nasales

Face-lift, Ciseaux à dissection, Ciseaux nasaux  
Face-lift, Forbici per dissezione, Forbici nasali

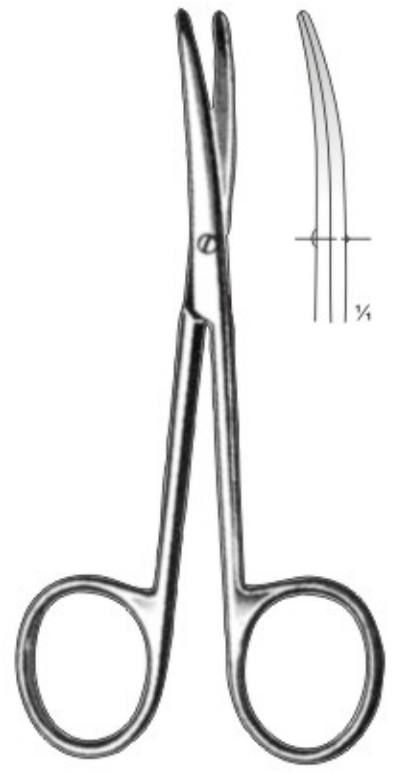
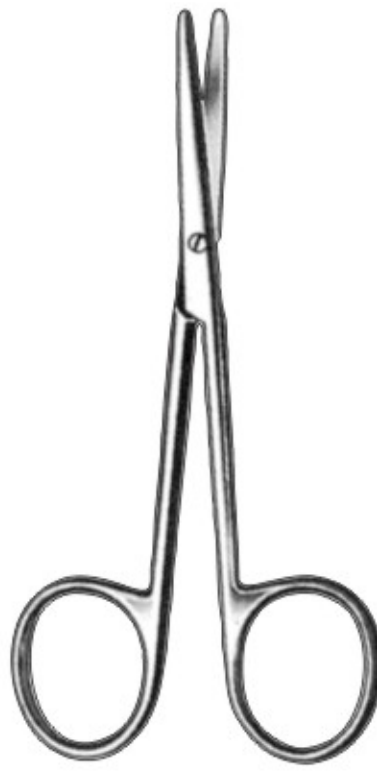
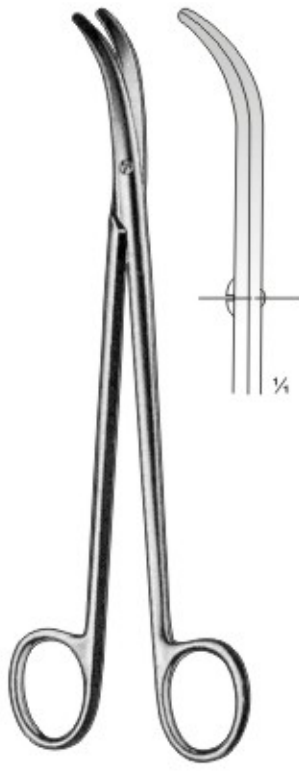
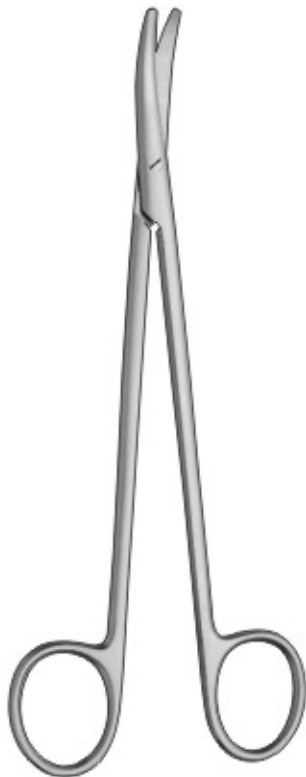

**THOREK-FELDMAN**  
Gall Bladder Scissor  
15-179-180  
18.0 cm, 7"

**THOREK**  
15-180-190  
19.0 cm, 7 ½"

**LEXER-BABY**  
15-181-100  
10.0 cm, 4"

**LEXER-BABY**  
15-182-100  
10.0 cm, 4"

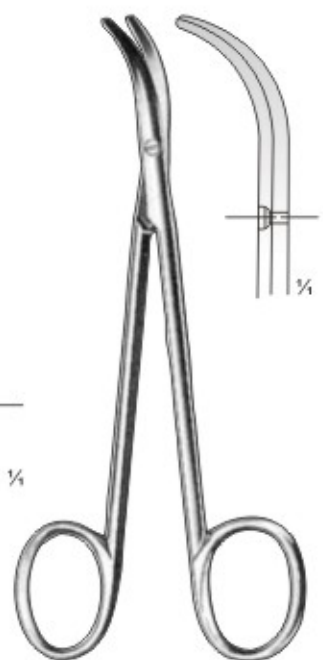
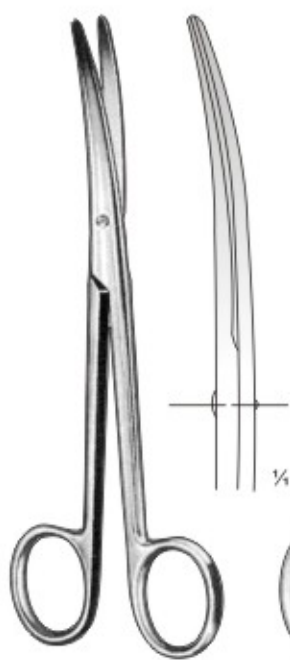
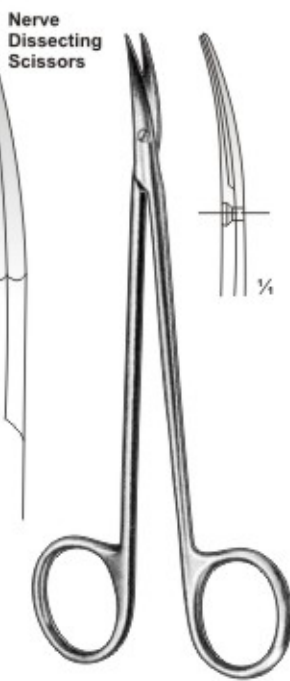
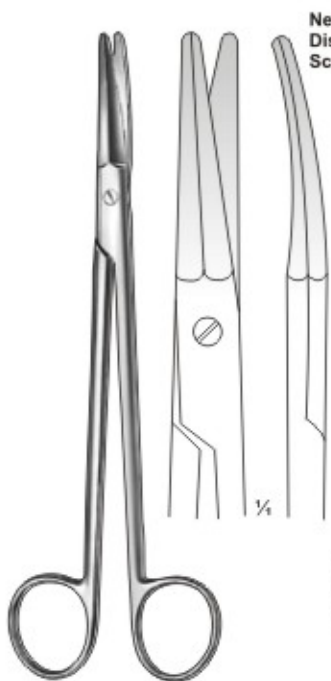

**KAYE FACE-LIFT  
SCISSORS**  
15-183-185  
18.5 cm, 7 ¼"

**Straight**  
15-184-150  
15.0 cm, 6"

**Curved**  
15-185-150  
15.0 cm, 6"

**LEXER**  
15-186-160  
16.0 cm, 6 ¼"

**LEXER**  
15-187-160  
16.0 cm, 6 ¼"

**FOMON**  
15-188-135  
13.5 cm, 5 ¼"





## OPERATING, DISSECTING SCISSORS

Chirurgische scheren, Präparierscheren  
Tijeras quirúrgicas, Tijeras de disección

Ciseaux chirurgicaux, Ciseaux à dissection  
Forbici per chirurgia, Forbici per dissezione



Plastic

**KILNER**  
15-189-120 12.0 cm, 4 3/4"  
15-190-150 15.0 cm, 6"  
15-191-180 18.0 cm, 7"  
15-192-200 20.0 cm, 8"  
Str.

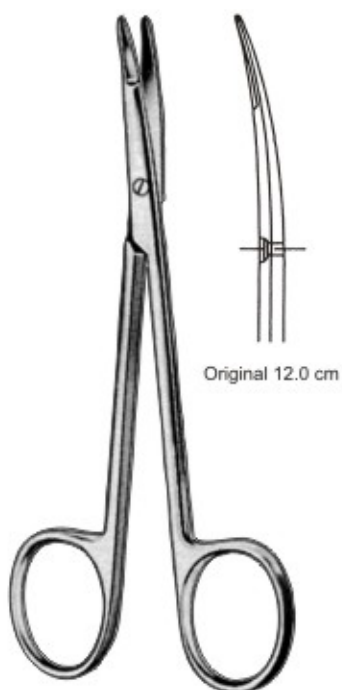

Original 12.0 cm

**KILNER**  
15-193-120 12.0 cm, 4 3/4"  
15-194-150 15.0 cm, 6"  
15-195-180 18.0 cm, 7"  
15-196-200 20.0 cm, 8"  
Cvd.



**REYNOLDS**  
15-197-150 15.0 cm, 6"  
15-198-180 18.0 cm, 7"  
Str.

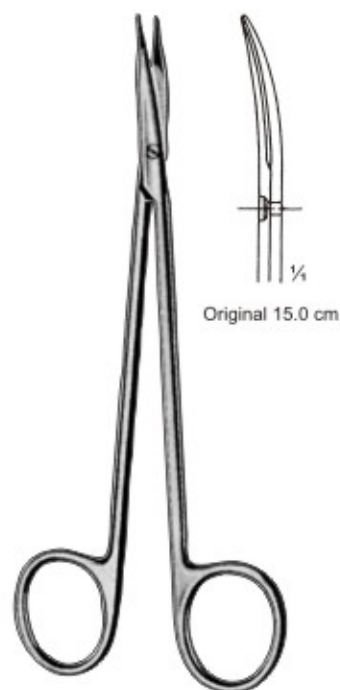

Original 15.0 cm

**REYNOLDS**  
15-199-150 15.0 cm, 6"  
15-200-180 18.0 cm, 7"  
Cvd.



**SANVENERO**  
15-201-140  
14.0 cm, 5 1/2"  
Str.

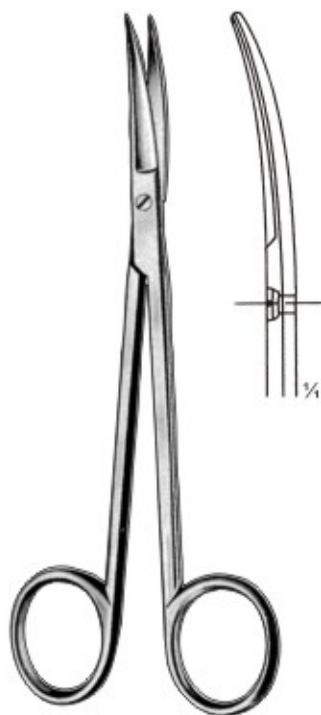

**SANVENERO**  
15-202-140  
14.0 cm, 5 1/2"  
Cvd.



**JOSEPH**  
15-203-140  
14.0 cm, 5 1/2"  
Str.

Plastic

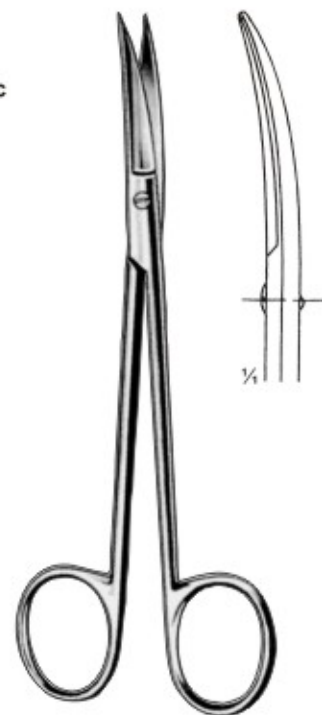

**JOSEPH**  
15-204-140  
14.0 cm, 5 1/2"  
Cvd.

# OPERATING, DISSECTING SCISSORS

Chirurgische scheren, Präparierscheren  
Tijeras quirúrgicas, Tijeras de disección

Ciseaux chirurgicaux, Ciseaux à dissection  
Forbici per chirurgia, Forbici per dissezione



**KELLY**  
15-205-160 16.0 cm, 6 1/4"  
15-206-180 18.0 cm, 7"  
Str.

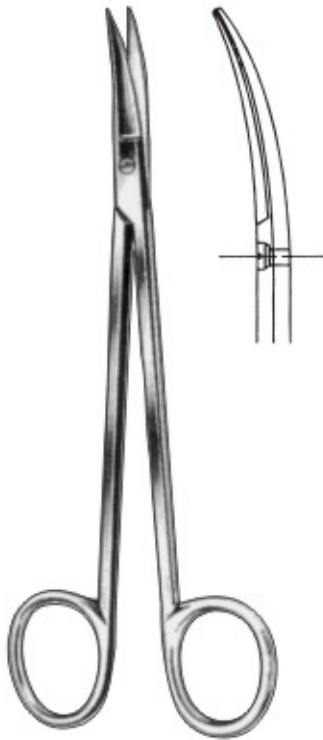

**KELLY**  
15-207-160 16.0 cm, 6 1/4"  
15-208-180 18.0 cm, 7"  
Cvd.



**VEZIEN**  
15-209-180  
18.0 cm, 7"

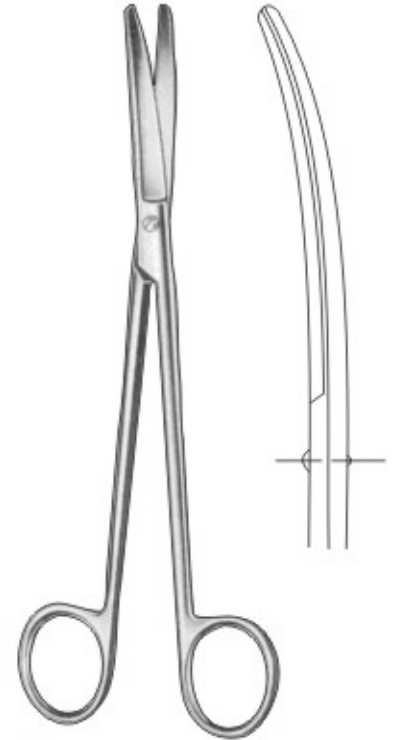

**WETHEIM**  
15-210-145 14.5 cm, 5 3/4"  
15-211-195 19.5 cm, 7 3/4"  
15-212-225 22.5 cm, 8 3/4"



**DOYEN**  
15-213-160  
16.0 cm, 6 1/4"  
S/B, Str.

**DOYEN**  
15-214-160  
16.0 cm, 6 1/4"  
B/B, Str.

**DOYEN**  
15-215-160  
16.0 cm, 6 1/4"  
B/B, Cvd.



**DOYEN**  
15-216-175  
17.5 cm, 6 3/4"  
B/B, Str.

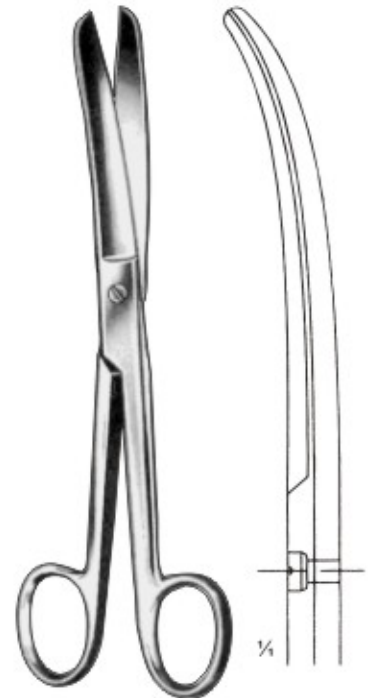

**DOYEN**  
15-217-175  
17.5 cm, 6 3/4"  
B/B, Cvd.



## DISSECTING & GYNECOLOGICAL SCISSORS

Präparierscheren, Gynäkologische Scheren  
Tijeras de disección, Tijeras para ginecología

Ciseaux à dissection, ciseaux à gynécologie  
Forbici per dissezione, Forbici per ginecologia



**DUBOIS**  
15-218-270  
27.0 cm, 10 3/4"



**DUBOIS**  
15-219-270  
27.0 cm, 10 3/4"

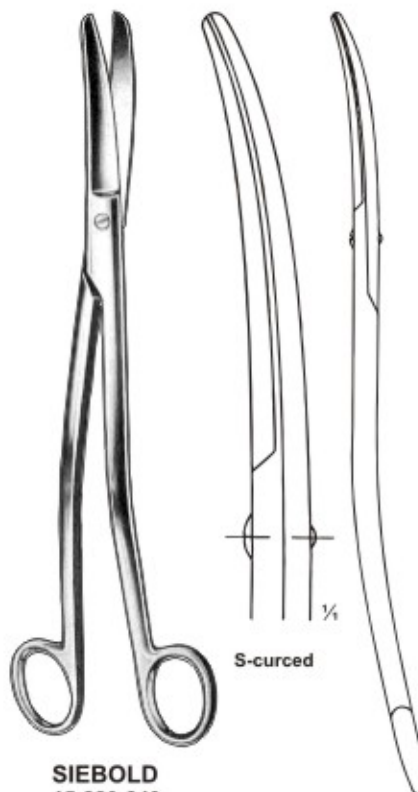

**SIEBOLD**  
15-220-240  
24.0 cm, 9 1/2"



**CARDINALE**  
15-221-280  
28.0 cm, 11"



**SIMS**  
15-222-200 20.0 cm, 8"  
15-223-230 23.0 cm, 9"  
Straight, B/B



**15-224-200**  
20.0 cm, 8"  
**15-225-230**  
23.0 cm, 9"  
S/B



**15-226-200**  
20.0 cm, 8"  
**15-227-230**  
23.0 cm, 9"  
S/S

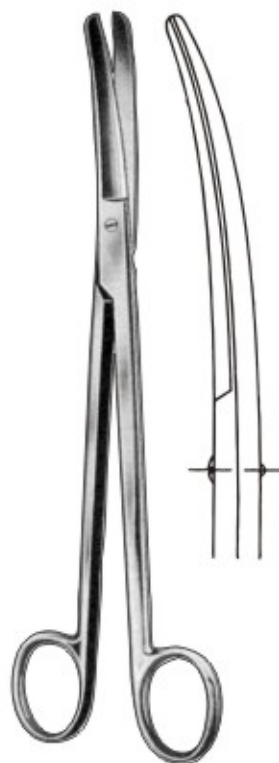

**SIMS**  
15-228-200 20.0 cm, 8"  
15-229-230 23.0 cm, 9"  
Curved, B/B



**15-230-200**  
20.0 cm, 8"  
**15-231-230**  
23.0 cm, 9"  
S/B



**15-232-200**  
20.0 cm, 8"  
**15-233-230**  
23.0 cm, 9"  
S/S

# IRIS, TENDON SCISSORS



Irisscheren, Schnenscheren  
Tijeras para Iridectomía, Tijeras para tendones

Ciseaux à iridectomie, Ciseaux à Ténotomie  
Forbici per iridectomia, Forbici per tenotomia



**15-234-100**  
10 cm, 4"  
Large Rings, Straight  
Sharp / Sharp  
**15-235-100**  
10 cm, 4"  
Large Rings, Curved  
Sharp / Sharp

IRIS

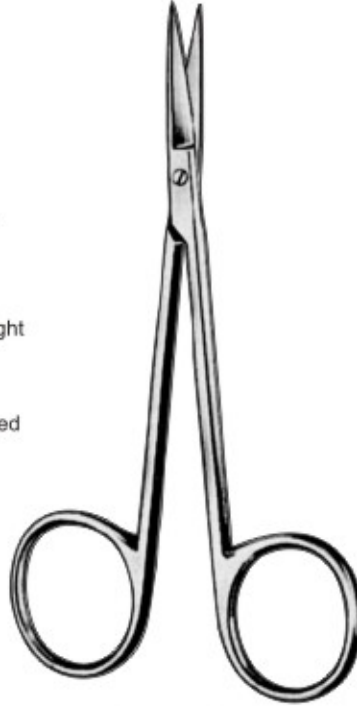

IRIS SCISSORS

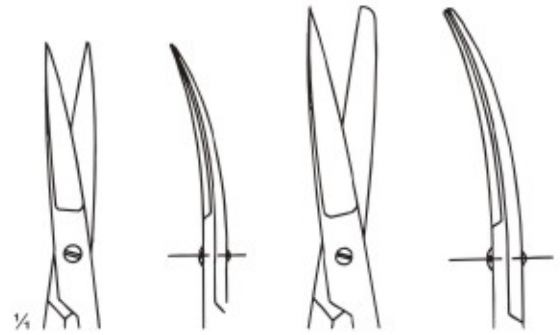

Item	Description	Tip
15-236-090	09 cm, 3 1/2" Straight	Sharp/Sharp
15-237-105	10.5 cm, 4 1/4" Straight	Sharp/Sharp
15-238-115	11.5 cm, 4 1/2" Straight	Sharp/Sharp
15-239-120	12.0 cm, 4 3/4" Straight	Sharp/Sharp
15-240-090	09 cm, 3 1/2" Curved	Sharp/Blunt
15-241-105	10.5 cm, 4 1/4" Curved	Sharp/Blunt
15-242-115	11.5 cm, 4 1/2" Curved	Sharp/Blunt
15-243-120	12.0 cm, 4 3/4" Curved	Sharp/Blunt

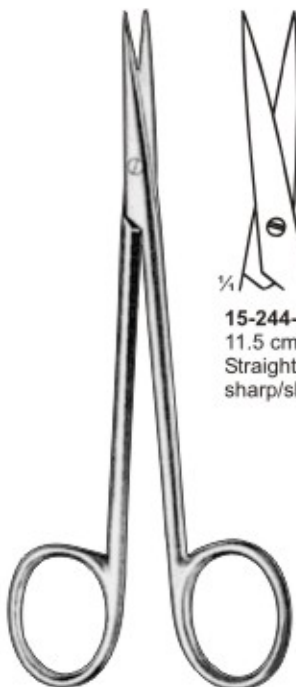

**15-244-115**  
11.5 cm, 4 1/2"  
Straight,  
sharp/sharp

KILLNER



**15-245-115**  
11.5 cm, 4 1/2"  
Curved,  
sharp/sharp

LITTLER



**15-246-140**  
14 cm, 5 1/2"  
Curved,  
sharp/sharp

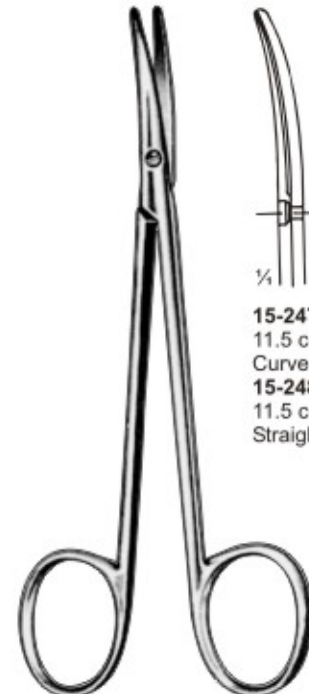

**15-247-115**  
11.5 cm, 4 1/2"  
Curved, blunt/blunt  
**15-248-115**  
11.5 cm, 4 1/2"  
Straight, blunt/blunt

STRABISMUS



## IRIS SCISSORS

Irisscheren  
Tijeras para Iridectomía

Ciseaux à iridectomie  
Forbici per iridectomia



**IRIS ANGULAR**  
15-249-114  
11.4 cm, 4 1/2"



**IRIS**  
15-250-115  
11.5 cm, 4 1/2"

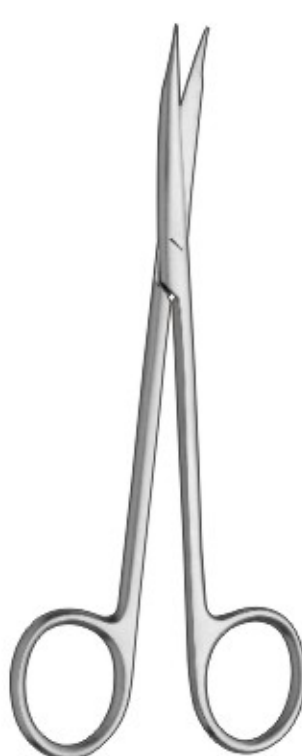

**POTTS-REYNOLDS  
TENOTOMY**  
15-251-120  
12.0 cm, 4 3/4"  
Curved



**POTTS TENOTOMY**  
15-252-152 15.2 cm, 6"  
15-253-178 17.8 cm, 7"  
15-254-203 20.3 cm, 8"

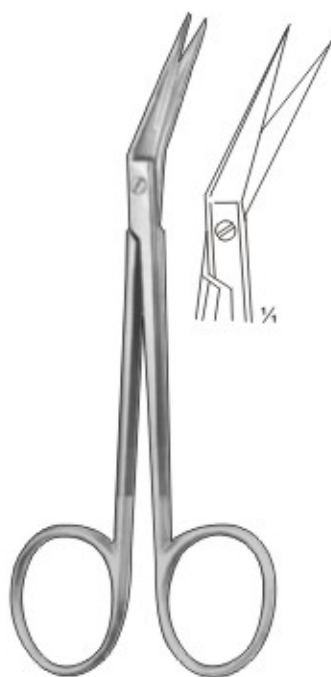

**IRIS ANGULAR**  
15-255-110  
11cm 4 1/4"

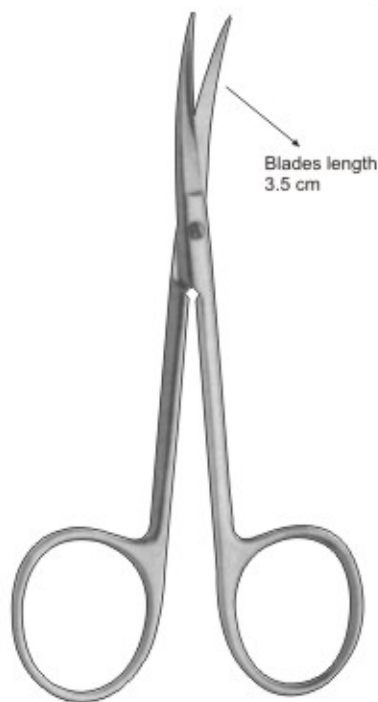

**KNAPP IRIS**  
15-256-102 Straight.  
15-257-102 Curved  
10.2 cm, 4"



**WILMER IRIS**  
15-258-089  
8.9 cm, 3 1/2"

# DISSECTING SCISSORS



Präparierscheren  
Tijeras de disección

Ciseaux à dissection  
Forbici per dissezione

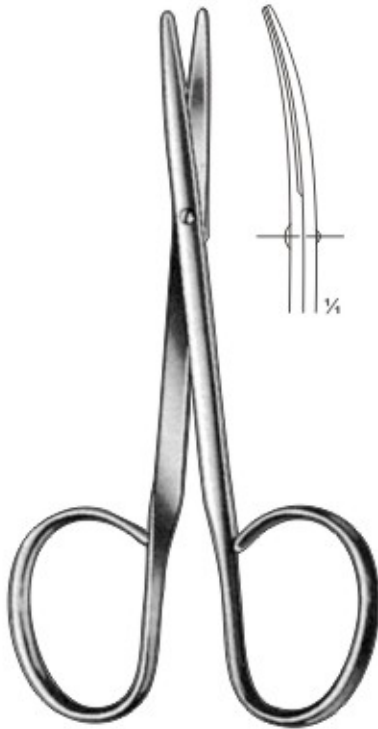

**15-259-100**  
10.0 cm, 4"  
Straight



**15-260-100**  
10.0 cm, 4"  
Curved

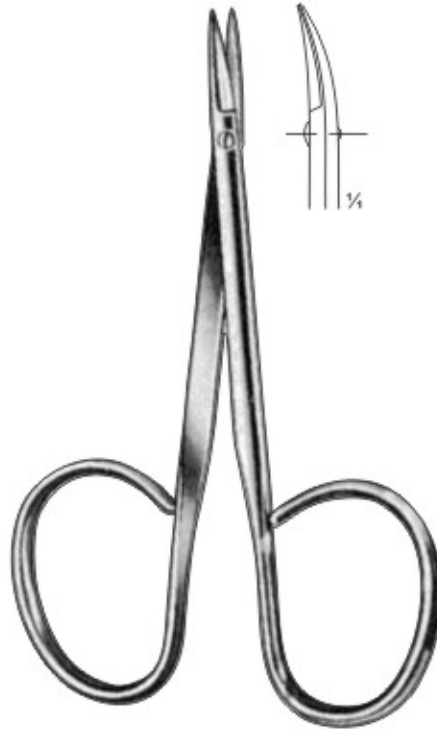

**15-261-095**  
9.5 cm, 3 3/4"  
Straight



**15-262-095**  
9.5 cm, 3 3/4"  
Curved

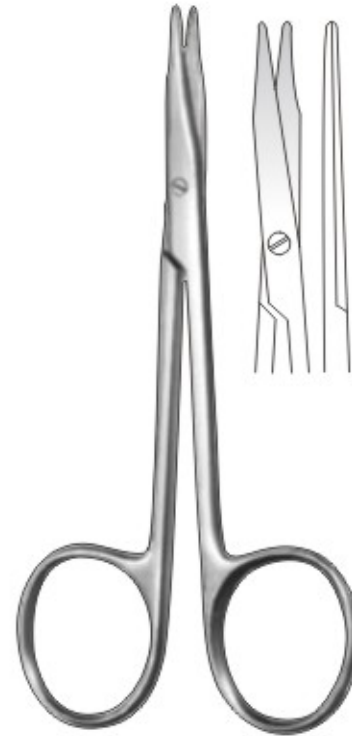

**TENOTOMY-STEVENS**  
**15-263-110** Straight  
**15-264-110** Curved  
11 cm, 4 1/4"

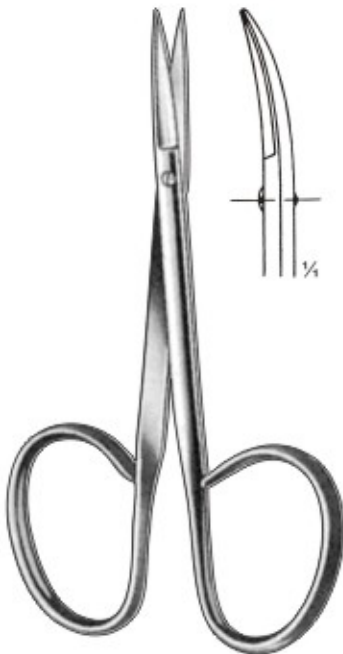

**15-265-100**  
10.0 cm, 4"  
Straight



**15-266-100**  
10.0 cm, 4"  
Curved



**15-267-100**  
10.0 cm, 4"  
Straight



**15-268-100**  
10.0 cm, 4"  
Curved

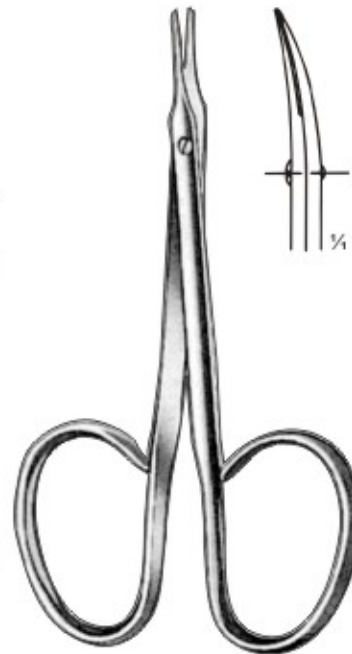

**TENOTOMY**  
**15-269-095**  
9.5 cm, 3 3/4"  
Curved-Ribbon  
Handles blunt/blunt



**15-270-095**  
9.5 cm, 3 3/4"  
Straight

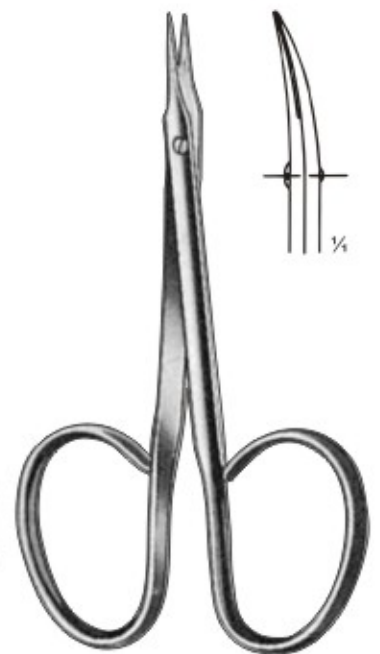

**15-271-095**  
9.5 cm, 3 3/4"  
Curved



## DISSECTING SCISSORS

Präparierscheren  
Tijeras de disección

Ciseaux à dissection  
Forbici per dissezione

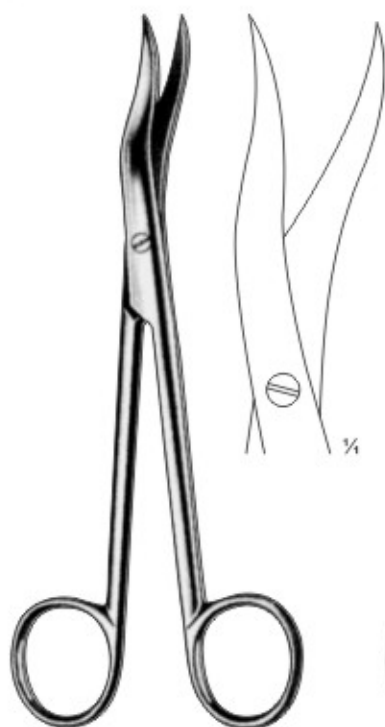

15-272-160  
16.0 cm, 6 1/4"

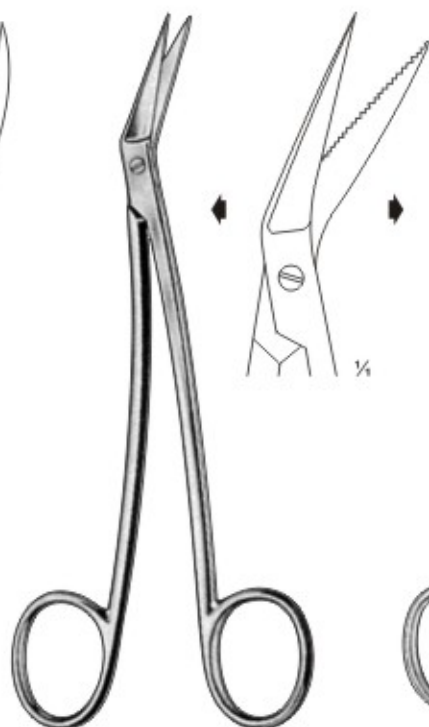

LOCKLIN  
15-273-165  
16.5 cm, 6 1/2"



LOCKLIN  
15-274-165  
16.5 cm, 6 1/2"

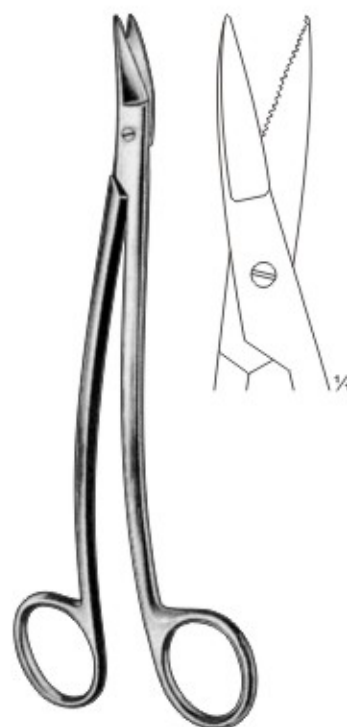

DEAN-DELLICATE  
15-275-170  
17.0 cm, 6 3/4"

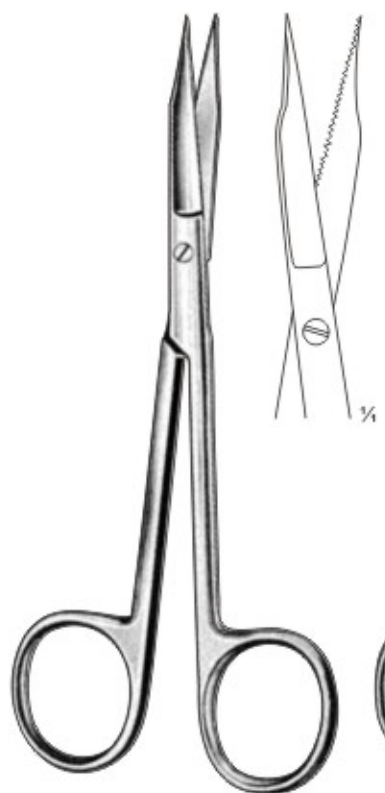

GOLDMAN-FOX  
15-276-130  
13.0 cm, 5"

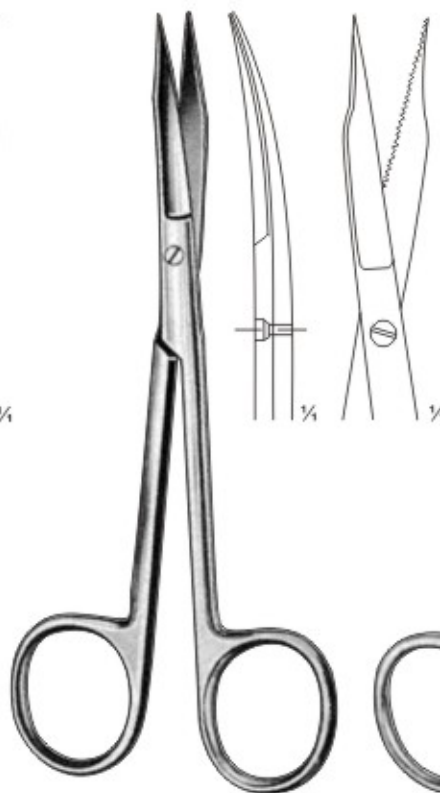

GOLDMAN-FOX  
15-277-130  
13.0 cm, 5"

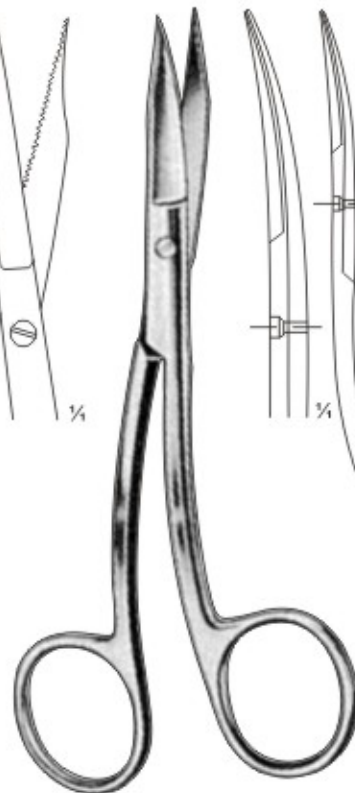

GOLDMAN-FOX (Spezial)  
15-278-130  
13.0 cm, 5"

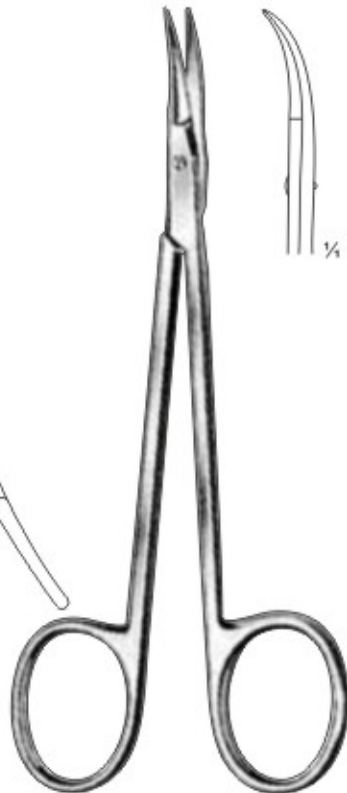

15-279-115  
11.5 cm, 4 1/2"

# VASCULAR SCISSORS



Gefäßscheren  
Tijeras vasculares

Ciseaux vasculaires  
Forbici vascolari



**15-280-190**  
19.0 cm, 7 1/2"

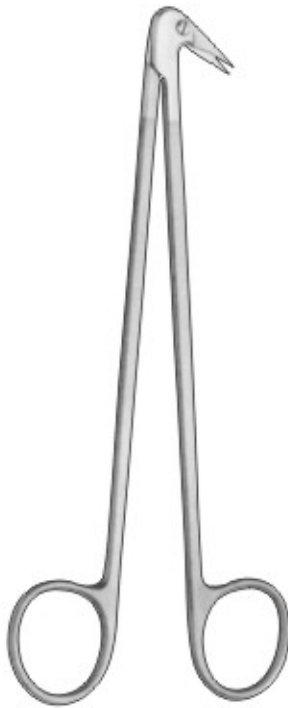

**COOLEY REVERSE  
Cut Scissors**  
**15-281-171**  
angled 120°  
17.1 cm, 6 3/4"

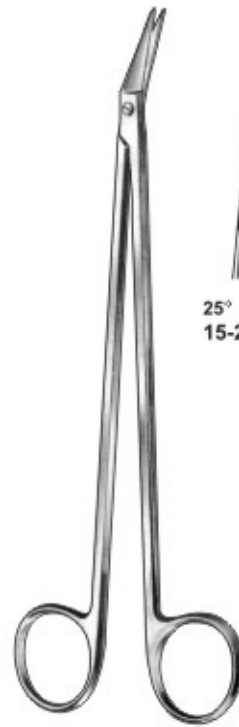

**POTTS-SMITH**  
19.0 cm, 7 1/2"



25°  
**15-282-190**



45°  
**15-283-190**



60°  
**15-284-190**

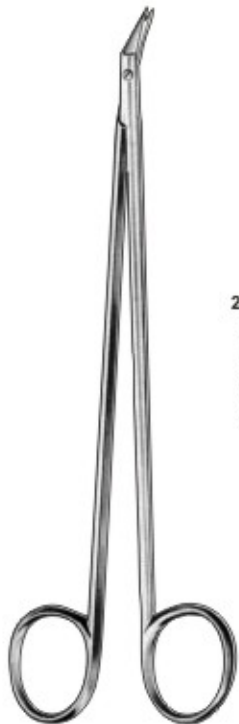

**HEGEMANN-DIETRICH**



25°  
**15-285-160**  
16.0 cm, 6 1/4"  
**15-286-190**  
19.0 cm, 7 1/2"



45°  
**15-287-160**  
16.0 cm, 6 1/4"  
**15-288-190**  
19.0 cm, 7 1/2"



60°  
**15-289-160**  
16.0 cm, 6 1/4"  
**15-290-190**  
19.0 cm, 7 1/2"



90°  
**15-291-160**  
16.0 cm, 6 1/4"  
**15-292-190**  
19.0 cm, 7 1/2"



125°  
**15-293-160**  
16.0 cm, 6 1/4"  
**15-294-190**  
19.0 cm, 7 1/2"





# VASCULAR SCISSORS

Gefäßscheren  
Tijeras vasculares

Ciseaux vasculaires  
Forbici vascolari



**POTTS-DE MARTEL**  
15-295-210  
21.0 cm, 8 1/4"



**MILLS**  
15-296-210  
21.0 cm, 8 1/4"



**FULTON**  
15-297-170  
17.0 cm, 6 3/4"

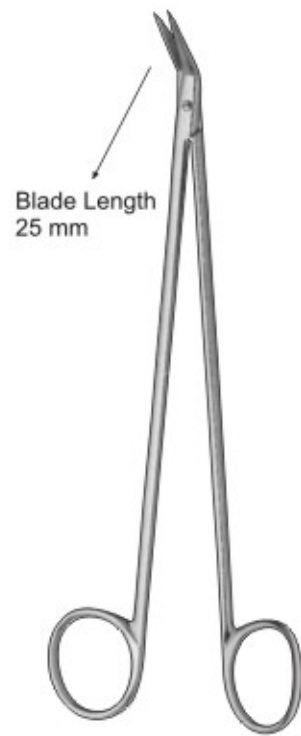

Blade Length  
25 mm

**POTTS-SMITH**  
15-298-197  
19.7 cm, 8"  
angled on flat 50°



Blade Length  
13 mm

**POTTS-SMITH SCISSORS**  
15-299-133  
Short.  
Angled 45°  
13.3 cm, 5 1/4"

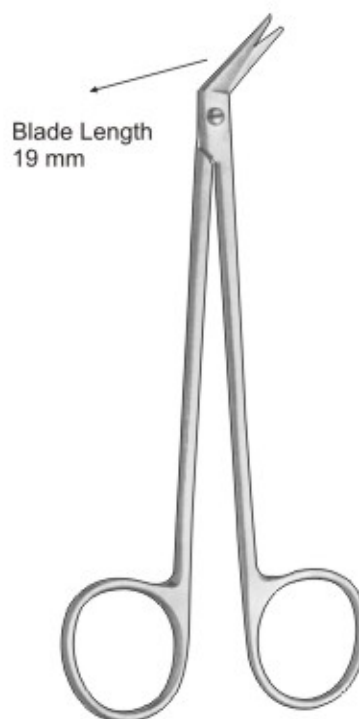

Blade Length  
19 mm

**POTTS-SMITH SCISSORS**  
15-300-146  
short blades  
angled 45°  
14.6 cm, 5 3/4"



Delicate Blade  
13 mm

**POTTS-SMITH**  
15-301-191 19.1 cm, 7 1/2" angled 25°  
15-302-133 13.3 cm, 5 1/4" angled 45°  
15-303-191 19.1 cm, 7 1/2" angled 45°  
15-304-191 19.1 cm, 7 1/2" angled 60°  
15-305-191 19.1 cm, 7 1/2" angled 90°

# VASCULAR SCISSORS



Gefäßscheren  
Tijeras vasculares

Ciseaux vasculaires  
Forbici vascolari



DE BAKEY



25° ¼

- 15-306-160 16.0 cm, 6 ¼"
- 15-307-190 19.0 cm, 7 ½"
- 15-308-230 23.0 cm, 9"
- 15-309-280 28.0 cm, 11"



45° ¼

- 15-310-160 16.0 cm, 6 ¼"
- 15-311-190 19.0 cm, 7 ½"
- 15-312-230 23.0 cm, 9"
- 15-313-280 28.0 cm, 11"

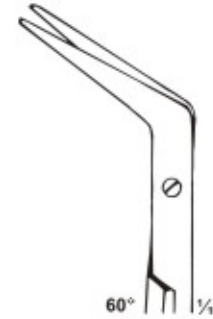

60° ¼

- 15-314-160 16.0 cm, 6 ¼"
- 15-315-190 19.0 cm, 7 ½"
- 15-316-230 23.0 cm, 9"
- 15-317-280 28.0 cm, 11"

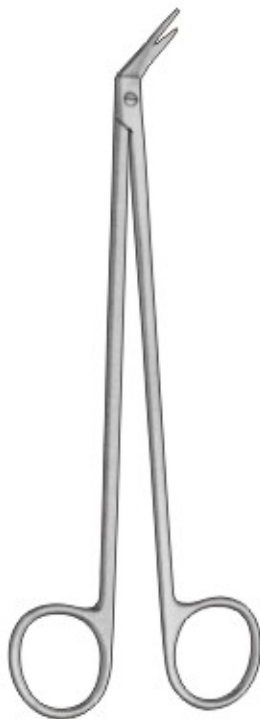

- COOLEY** 15-318-184  
angled 45° 1 mm probe point on tip.  
18.4 cm, 7 ½" 15-319-184  
1.5 mm probe point on tip.



- O'BRIEN**  
15-320-090  
9.0 cm, 3 ½"

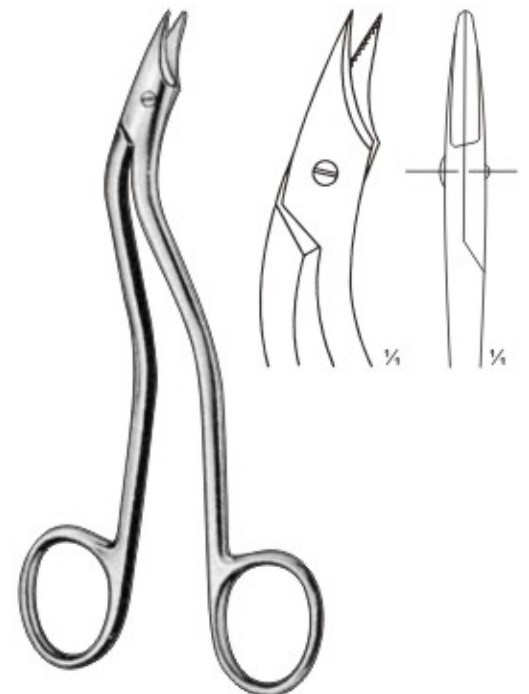

- HEATH**  
15-321-150  
15.0 cm, 6"



## VASCULAR SCISSORS

Gefäßscheren  
Tijeras vasculares

Ciseaux vasculaires  
Forbici vascolari

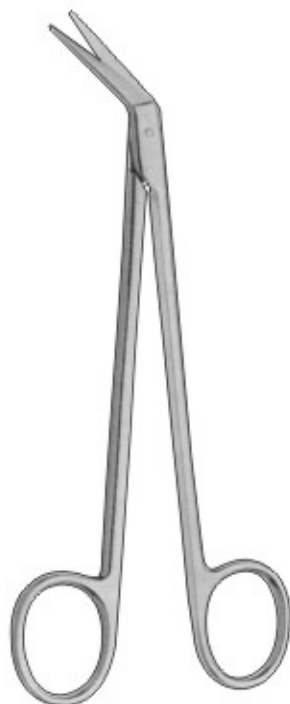

**LITWIN ANGLED**  
15-322-184  
18.4 cm, 7 1/4"  
Angled 45°

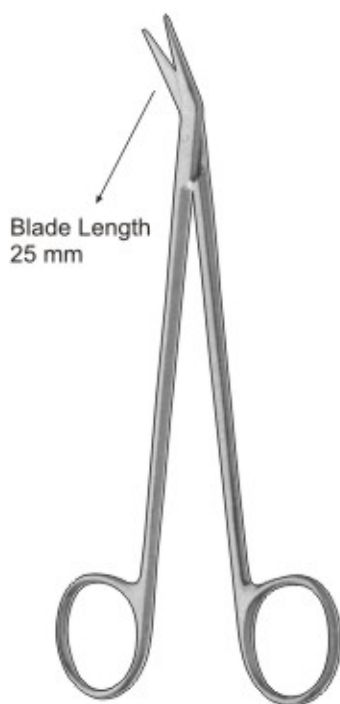

Blade Length  
25 mm

**DEBAKEY-POTTS**  
15-323-165 angled 20°  
15-324-165 angled 45°  
15-325-165 angled 60°  
16.5 cm, 6 1/2"

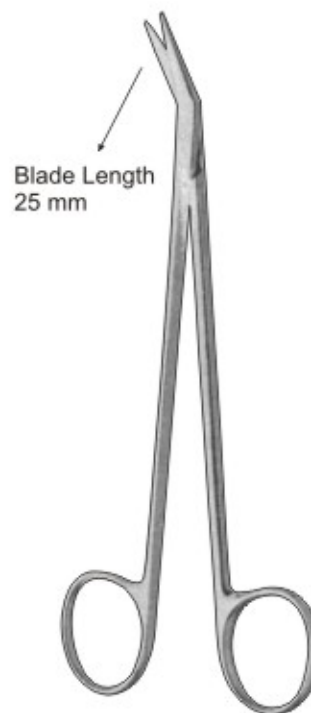

Blade Length  
25 mm

**DEBAKEY VASCULAR**  
15-326-229 angled 25°  
15-327-229 angled 45°  
15-328-229 angled 60°  
15-329-229 angled 45°  
22.9 cm, 9"

# VASCULAR SCISSORS



Gefäßscheren  
Tijeras vasculares

Ciseaux vasculaires  
Forbici vascolari

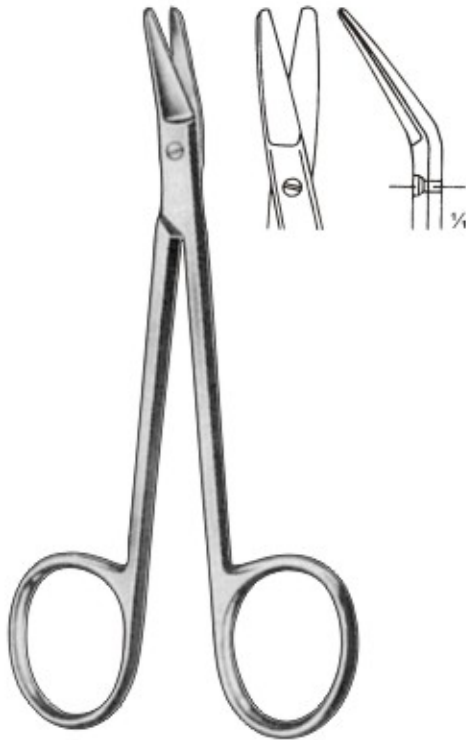

**15-330-105**  
10.5 cm, 4"

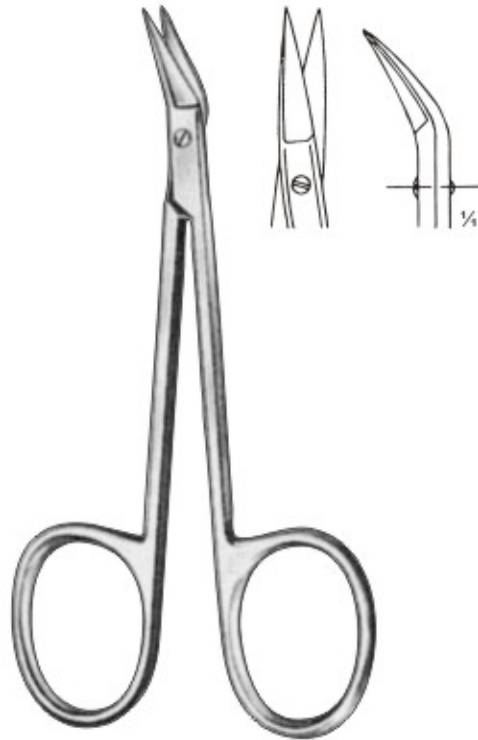

**15-331-100**  
10.0 cm, 4"

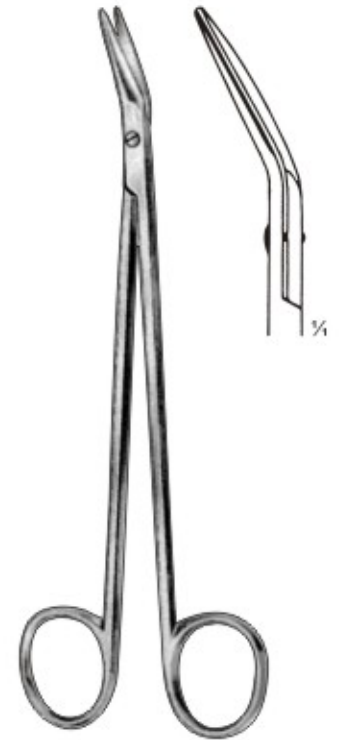

**CLASSON**  
**15-332-170**  
17.0 cm, 4"

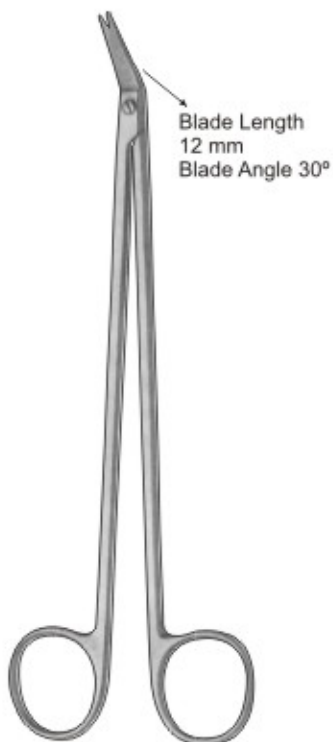

**COOLEY ARTERIOTOMY**  
**15-333-184** 18.4 cm, 7 1/4"  
**15-334-229** 22.9 cm, 9"  
**15-335-273** 27.3 cm, 11"



**SWEET ESOPHAGEAL**  
**15-336-216**  
21.6 cm, 8 1/2"

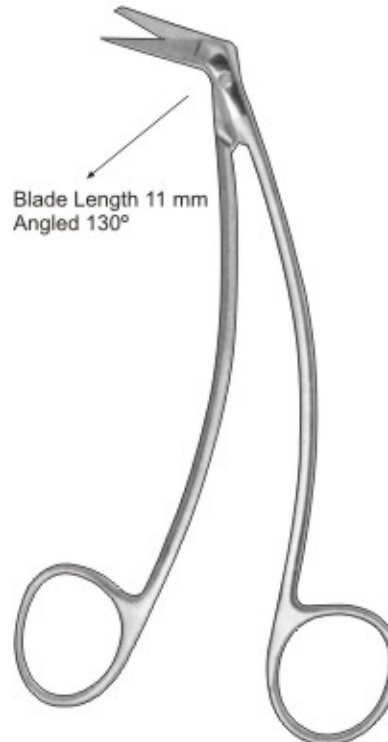

**FAVALORO**  
**CORONARY**  
**15-337-171**  
17.1 cm, 6 3/4"



**15-338-105**  
10.5 cm, 4"  
Angled 90°



## VASCULAR SCISSORS

Gefäßscheren  
Tijeras vasculares

Ciseaux vasculaires  
Forbici vascolari

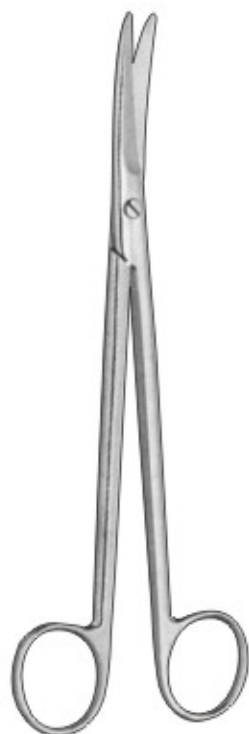

### COOLEY CARDIOVASCULAR

15-339-191 19.1 cm, 7 1/2"  
15-340-229 22.9 cm, 9"  
Curved



### CRAFOORD LOBECTOMY

15-341-305  
30.5 cm, 12"  
curved



### NELSON LUNG DISSECTING

15-342-229 Straight  
15-343-229 Curved  
22.9 cm, 9"



### FINOCHIETTO

15-344-270  
27.0 cm, 10 1/2"



### RESANO

15-345-250  
25.0 cm, 10"

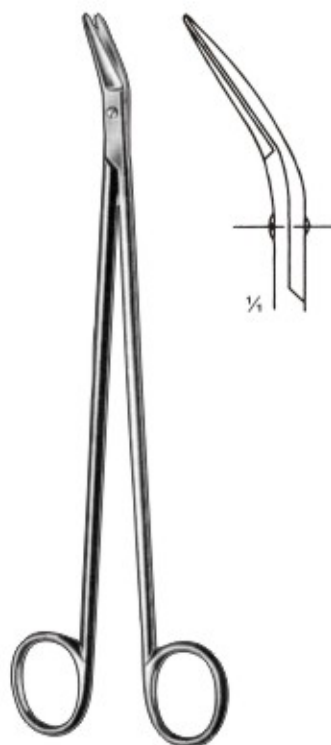

### POTTS-SMITH

15-346-195  
19.5 cm, 7 3/4"

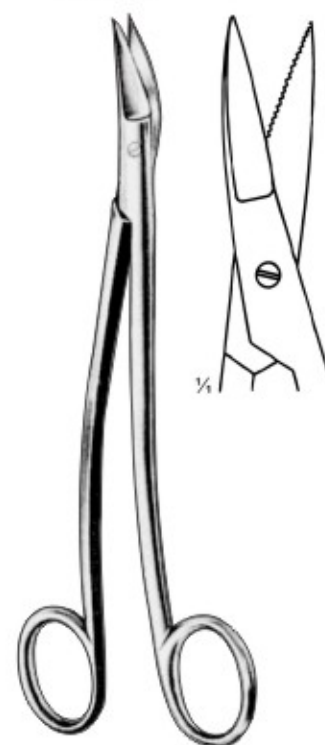

### ENT-DEAN

15-347-170  
17 cm, 6 3/4"  
Serrated

# VASCULAR SCISSORS



Gefäßscheren  
Tijeras vasculares

Ciseaux vasculaires  
Forbici vascolari

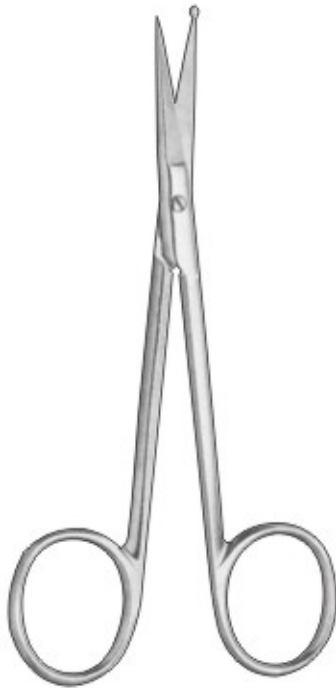

**CARDIOVASCULAR**  
15-348-121  
12.1 cm, 4 3/4"  
curved

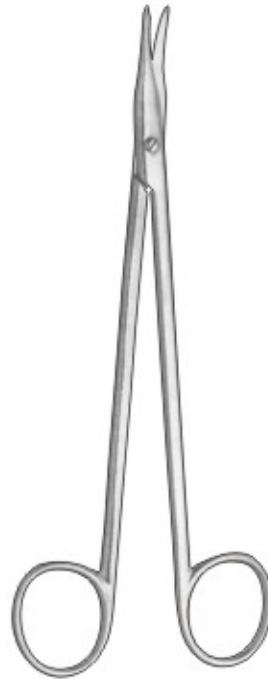

**MORSE SCISSORS**  
15-349-178  
17.8 cm, 7"  
curved



**LITWAK GENERAL UTILITY**  
15-350-117  
11.7 cm, 4 3/4"



**MAYO-HARRINGTON DISSECTING**  
15-351-229 22.9 cm, 9" Straight.  
15-352-279 27.9 cm, 11" Straight.  
15-353-229 22.9 cm, 9" Curved.  
15-354-279 27.9 cm, 11" Curved.



**TOENIS DISSECTING**  
15-355-184 Straight  
18.4 cm, 7 1/4"  
15-356-181 Curved.  
18.1 cm, 7"  
Delicate



**DEMARTEL VASCULAR**  
15-357-171 17.1 cm, 6 3/4" Curved.  
15-358-197 19.7 cm, 8" Straight.  
15-359-171 17.1 cm, 6 3/4" Straight.



**DEBAKEY ENDARTERECTOMY**  
15-360-178  
17.8 cm, 7"  
curved



## VASCULAR SCISSORS

Gefäßscheren  
Tijeras vasculares

Ciseaux vasculaires  
Forbici vascolari



**STRULLY**  
15-361-220  
22.0 cm, 8 3/4"



**STRULLY**  
15-362-220  
22.0 cm, 8 3/4"

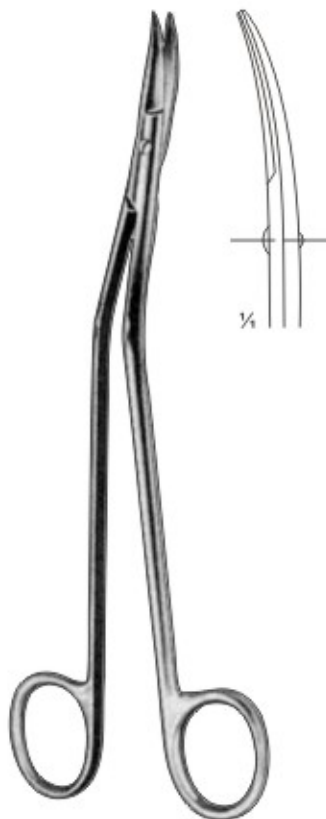

**DANDY**  
15-363-170  
17.0 cm, 6 3/4"

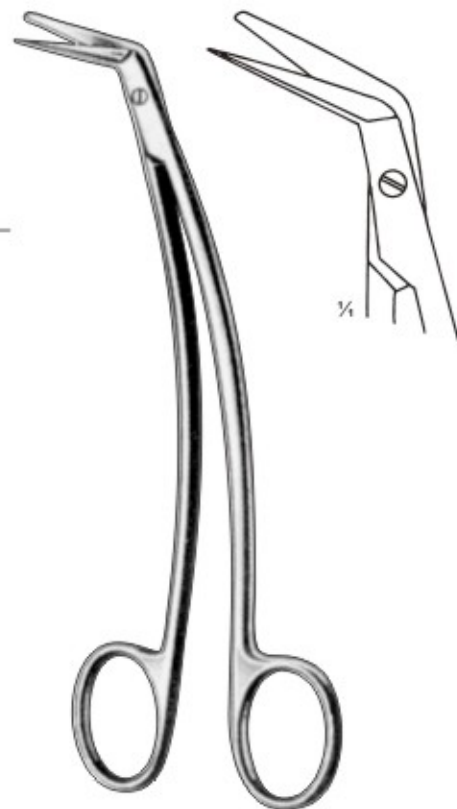

**FAVALORO**  
15-364-150  
15.0 cm, 6"



**15-365-115**  
11.5 cm, 4 1/2"



**15-366-145**  
14.5 cm, 5 3/4"



**15-367-145**  
14.5 cm, 5 3/4"

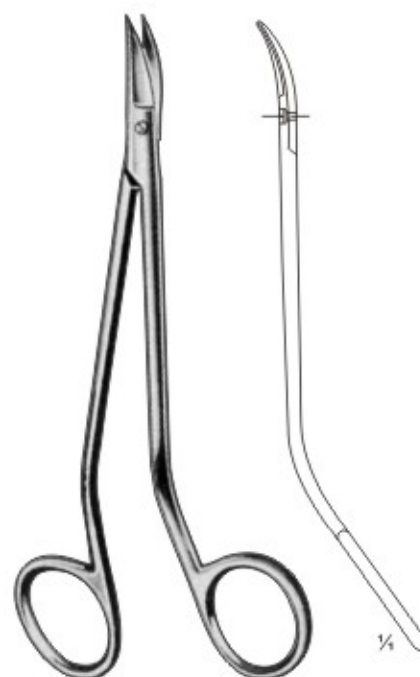

**NEUMANN**  
15-368-125  
12.5 cm, 5"

# VASCULAR SCISSORS



Gefäßscheren  
Tijeras vasculares

Ciseaux vasculaires  
Forbici vascolari

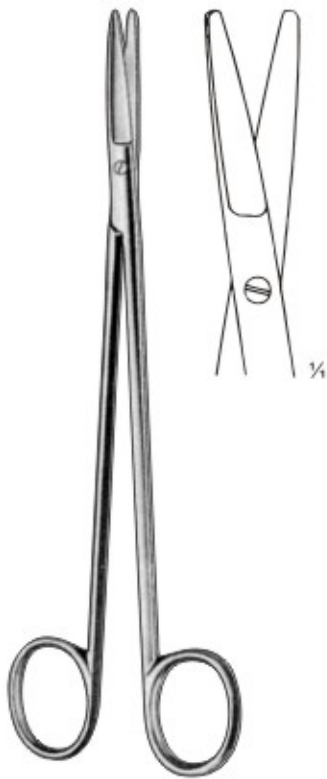

**TOENNIS**  
15-369-180  
18.0 cm, 7"

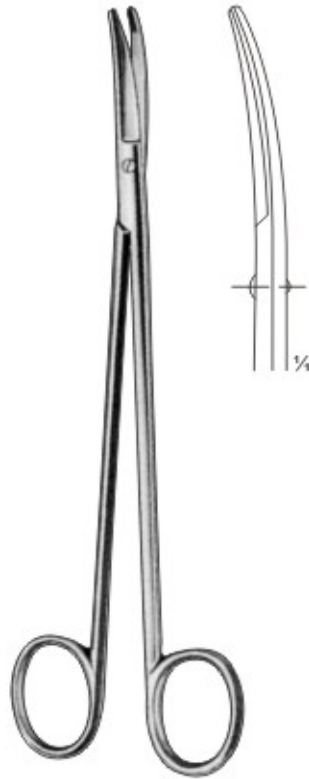

**TOENNIS**  
15-370-180  
18.0 cm, 7"



**QUINBY**  
15-371-120  
12.0 cm, 4 3/4"

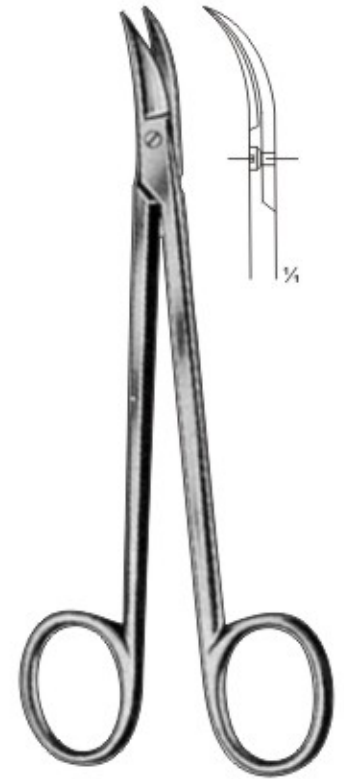

**QUINBY**  
15-372-120  
12.0 cm, 4 3/4"



**DE BAKEY**  
15-373-155  
15.5 cm, 6"

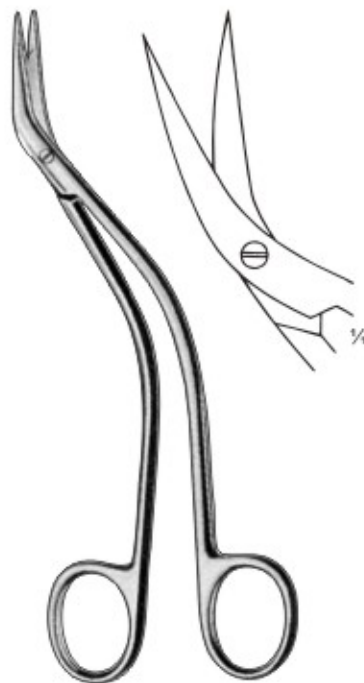

**DE BAKEY**  
15-374-155  
15.5 cm, 6"



**SCHMIEDEN-TAYLOR**  
15-375-145 14.5 cm, 5 3/4"  
15-376-175 17.5 cm, 6 3/4"

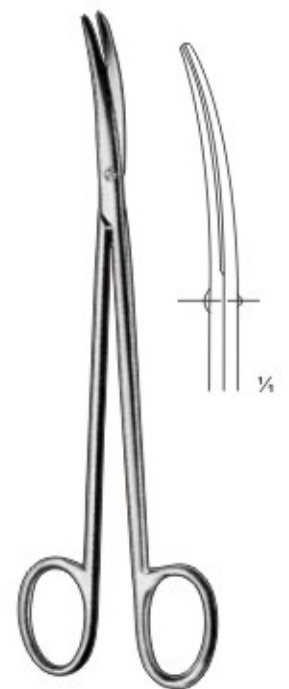

**TOENNIS-ADSON**  
15-377-175  
17.5 cm, 6 3/4"





## VASCULAR SCISSORS

Gefäßscheren  
Tijeras vasculares

Ciseaux vasculaires  
Forbici vascolari

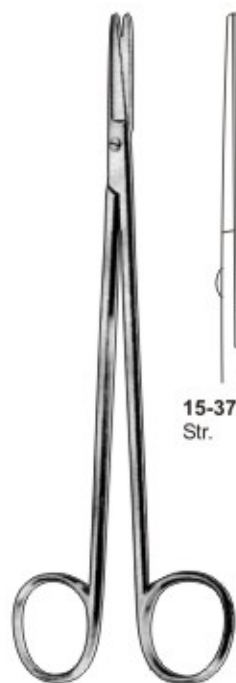

15-378-170  
Str.



15-379-170  
Cvd.

**CHURCH**  
17.0 cm, 6 3/4"

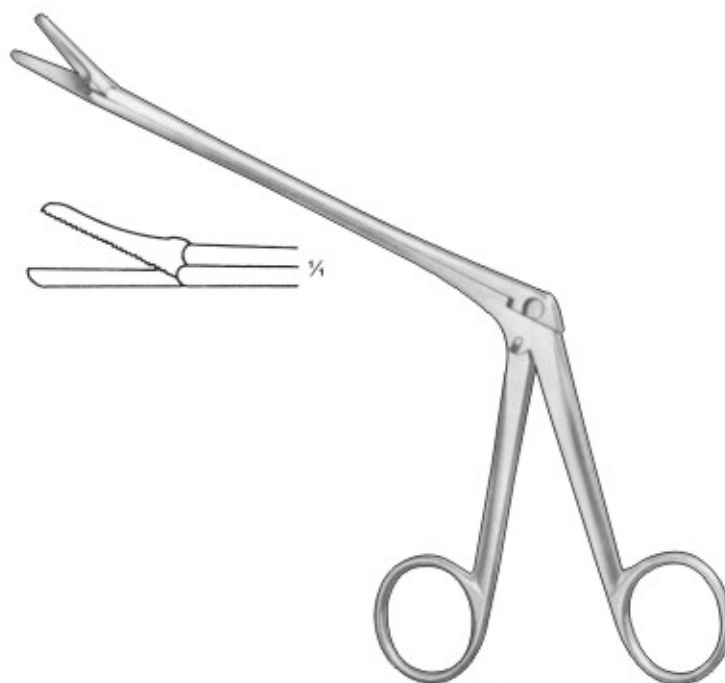

**OLIVECRONA**  
15-380-230  
23.0 cm, 9"



**KLINKENBERGH-LOTH**  
15-381-230  
23.0 cm, 9"

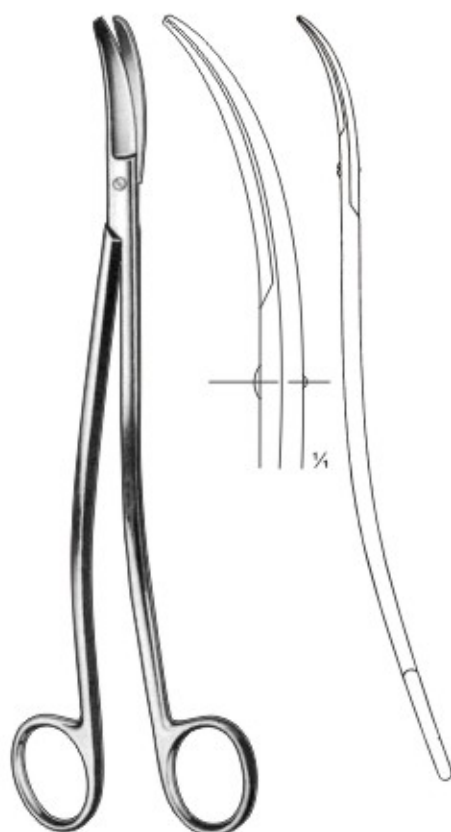

**SATINSKY**  
15-382-245  
24.5 cm, 9 3/4"

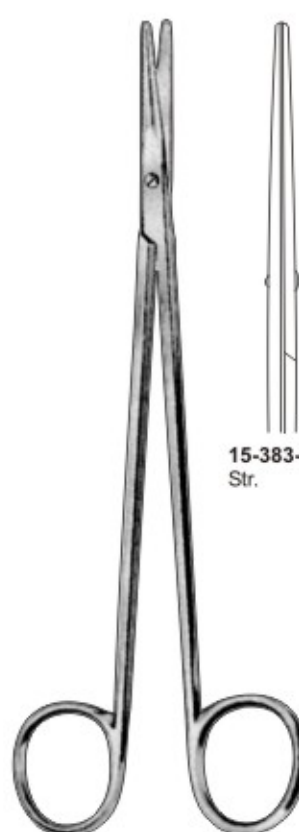

**LINCOLE**  
17.0 cm, 6 3/4"

15-383-170  
Str.

15-384-170  
Cvd.

# VASCULAR, ENTEROTOMY SCISSORS



Gefäßscheren, Darmscheren  
Tijeras vasculares, Tijeras para intestino

Ciseaux vasculaires, Ciseaux-entérotomes  
Forbici vascolari, Forbici per enterotomia



**ENTEROTOMY**  
15-385-210  
21.0 cm, 8 1/4"



**ENTEROTOMY**  
15-386-210  
21.0 cm, 8 1/4"



**ENTEROTOMY**  
15-387-210  
21.0 cm, 8 1/4"



**DISSECTING**  
15-388-110 11.5 cm, 4 1/4"  
15-389-130 13.0 cm, 5"  
15-390-140 14.0 cm, 5 1/2"



**DISSECTING**  
15-391-110 11.5 cm, 4 1/4"  
15-392-130 13.0 cm, 5"  
15-393-140 14.0 cm, 5 1/2"

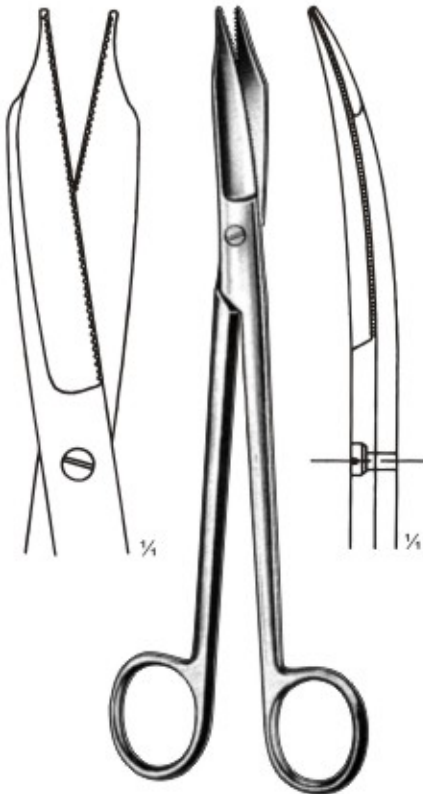

**MARTIN-CARTILAGE**  
15-394-200  
20.0 cm, 8"



**MC INDOE**  
15-395-190  
19.0 cm, 7 1/2"

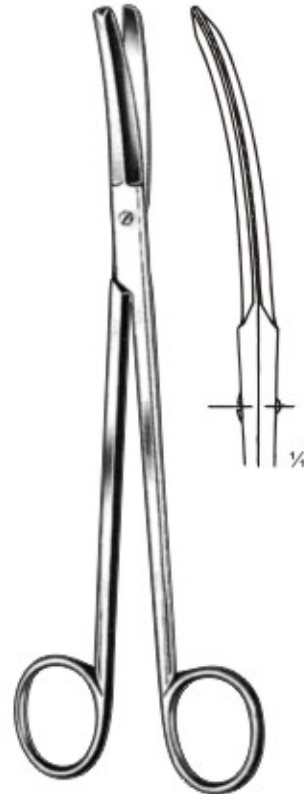

**POTTS-SMITH**  
15-396-190  
19.0 cm, 7 1/2"

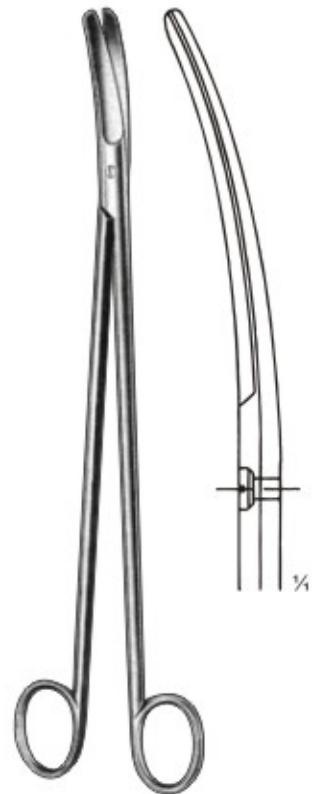

**CRAFOORD**  
15-397-300  
30.0 cm, 11 1/4"



## TONSIL, NASAL SCISSORS

Tonsillenscheren, Nasenscheren  
Tijeras para amígdalas, Tijeras nasales

Ciseaux pour les amygdales, Ciseaux nasaux  
Forbici per tonsille, Forbici nasali

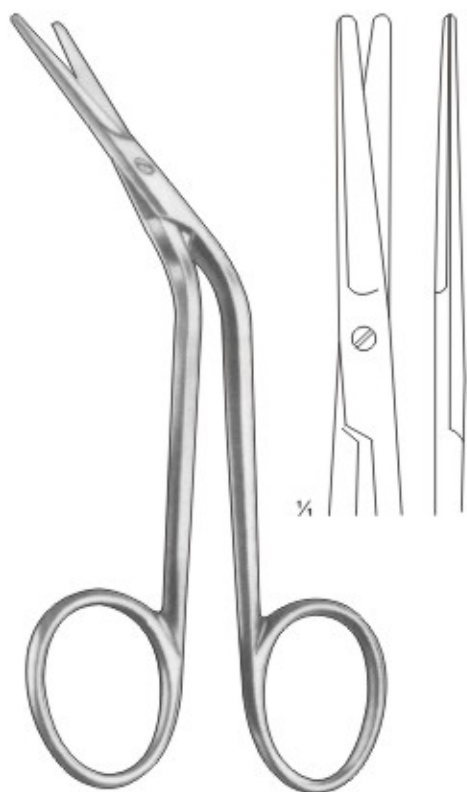

**COTTLE**  
15-398-160  
16 cm 6 1/4"

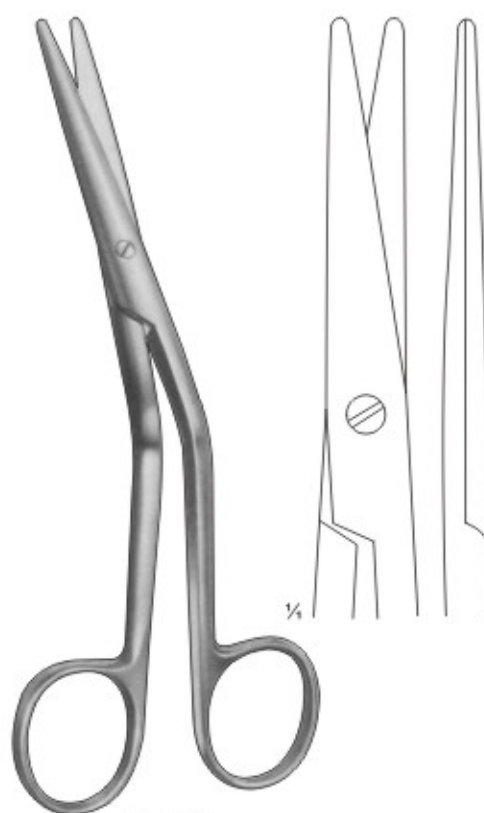

**FOMON**  
15-399-145  
14.5 cm 5 1/2"



**HEYMANN**  
15-400-180  
18 cm, 7"



**HEYMANN**  
15-401-195  
19.5 cm, 7 3/4"



**KNIGHT**  
15-402-180  
18.0 cm, 7"

# GUM, OPERATING SCISSORS



Zahnfleischscheren, Chirurgische Scheren  
Tijeras para encías, Tijeras quirúrgicas

Ciseaux à gencives, Ciseaux chirurgicaux  
Forbici per gengiva, Forbici per chirurgia



**WAGNER  
GUM SCISSORS**  
12.0 cm, 4 1/4"

Straight



1/4

15-403-120  
B/B



15-404-120  
S/B



15-405-120  
S/S

Curved



15-406-120  
B/B



15-407-120  
S/B



15-408-120  
S/S



**BROPHY (SULLIVAN)**  
15-409-140  
14.0 cm, 5 1/2"  
Str.



1/4

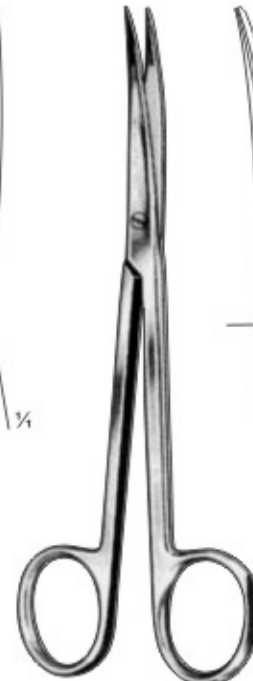

**BROPHY (SULLIVAN)**  
15-410-140  
14.0 cm, 5 1/2"  
Cvd.



1/4



**GOOD**  
15-411-190  
19.0 cm, 7 1/2"



1/4



**PRINCE**  
15-412-175  
17.5 cm, 6 3/4"



1/4



**HALLE**  
15-413-190  
19.0 cm, 7 1/2"

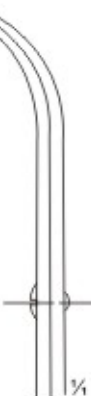

1/4



**SULLIVAN**  
15-414-145  
14.5 cm, 5 3/4"



1/4



**SULLIVAN**  
15-415-145  
14.5 cm, 5 3/4"



## OPERATING SCISSORS

Chirurgische scheren  
Tijeras quirúrgicas

Ciseaux chirurgicaux  
Forbici per chirurgia

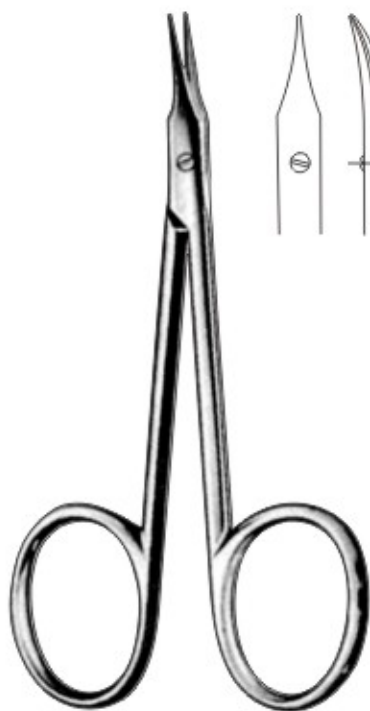

**WALTON**  
15-416-100  
10.0 cm, 4"

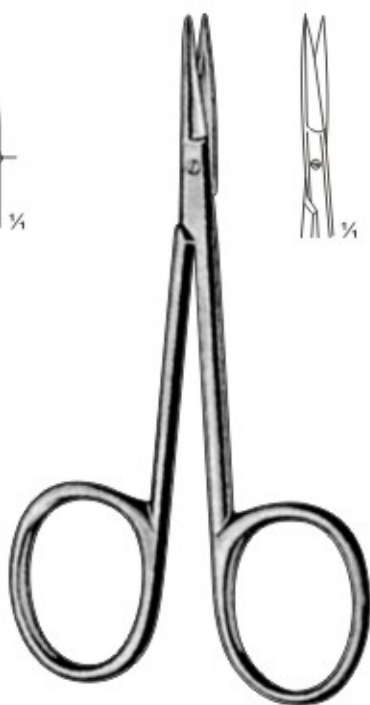

**MOD. BONN**  
15-417-080  
8.0 cm, 3"

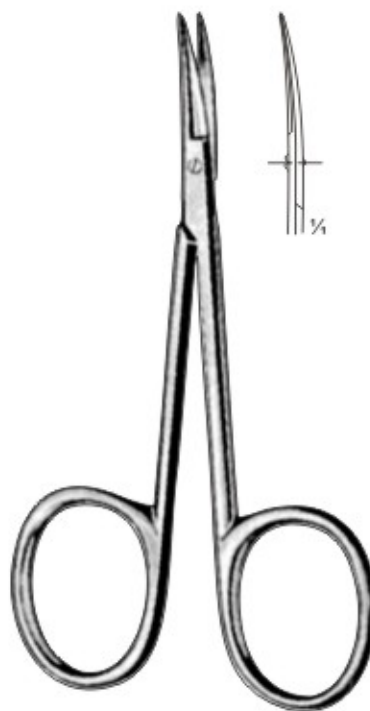

**MOD. BONN**  
15-418-080  
8.0 cm, 3"



**LANDOLT**  
15-419-125  
12.5 cm, 5"



**OPERATING FINE**  
15-420-120 Straight  
15-421-120 Curved  
12 cm, 4 1/2"



**15-422-140**  
14.0 cm, 5 1/2"



**15-423-105**  
10.5 cm, 4"  
**15-424-115**  
11.5 cm, 4 1/2"



**15-425-105**  
10.5 cm, 4"  
**15-426-115**  
11.5 cm, 4 1/2"



**15-427-115**  
11.5 cm, 4 1/2"

# GUM & STITCH SCISSORS



Zahnfleischscheren, Fadenscheren,  
Tijeras para encias, Tijeras para hilos,

Ciseaux à gencives, Ciseaux à ligatures,  
Forbici per gengiva, Forbici per legature,

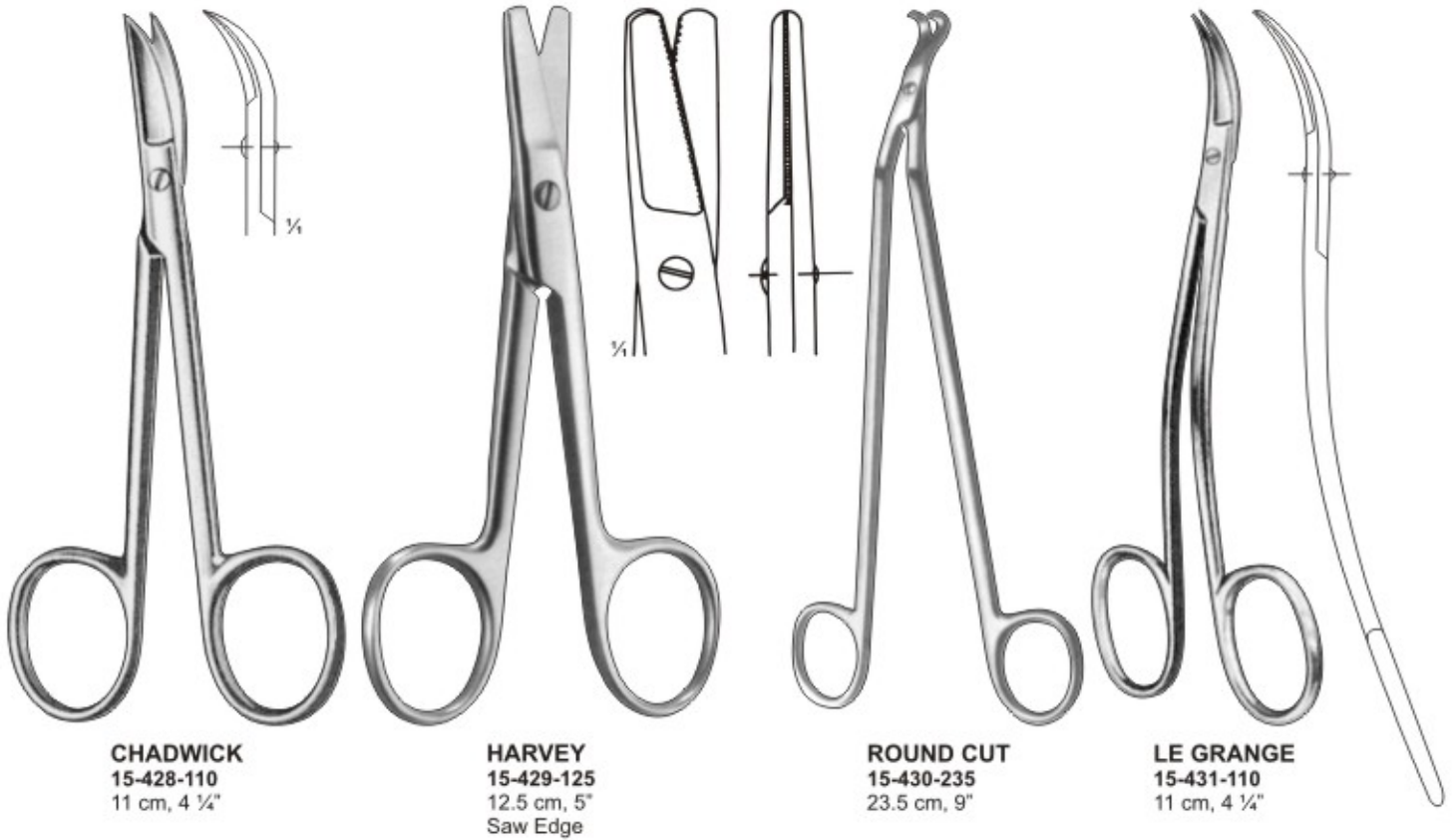

**CHADWICK**  
15-428-110  
11 cm, 4 1/4"

**HARVEY**  
15-429-125  
12.5 cm, 5"  
Saw Edge

**ROUND CUT**  
15-430-235  
23.5 cm, 9"

**LE GRANGE**  
15-431-110  
11 cm, 4 1/4"



**LANDOLT**  
15-432-125  
12.5 cm, 5"

**LANDOLT**  
15-433-125  
12.5 cm, 5"

**LANDOLT**  
15-434-125  
12.5 cm, 5"

**SCHOEMAKER-LOTH**  
15-435-125  
12.5 cm, 5"

**EISELSBERG**  
15-436-110  
11.0 cm, 4 1/4"



## STITCH SCISSORS

Fadenscheren  
Tijeras para hilos

Ciseaux à ligatures  
Forbici per legature



Saw Edge

15-437-120  
12.0 cm, 4 3/4"



**NORTHBENT**  
15-438-125  
12.5 cm, 5"



**LITTAUER**  
15-439-140  
14 cm, 5 1/2"



**BUCK**  
15-440-145 14.5 cm, 5 3/4"  
15-441-180 18.0 cm, 7"

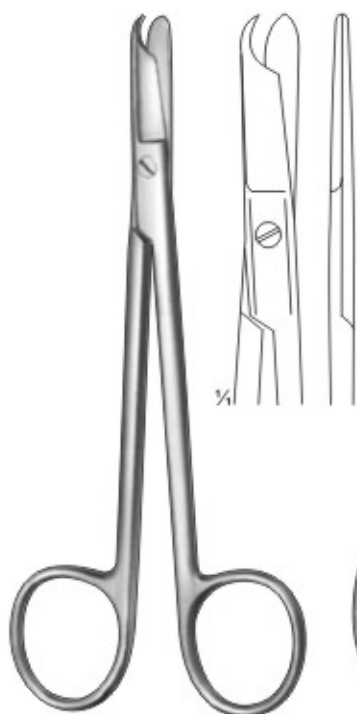

**SPENCER**  
15-442-090  
9 cm, 3 1/2"

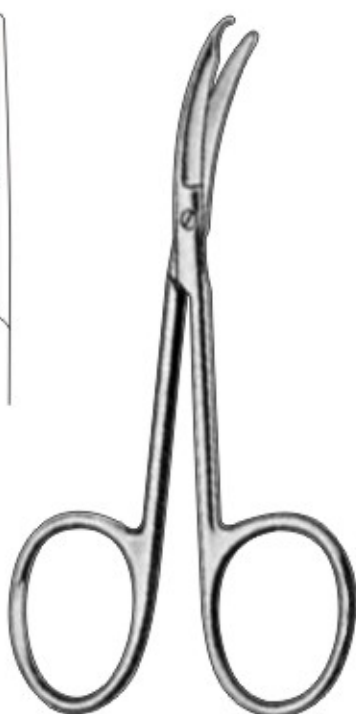

**SHORTBENT**  
15-443-090  
9 cm, 3 1/2"



**SPENCER / DELICATE**  
15-444-110  
11 cm, 4 1/2"



15-445-115  
11.5 cm, 4 3/4"

# WIRE CUTTING SCISSORS



*Drahtscheren*  
*Tijeras para alambres*

*Cisailles à fils*  
*Forbici per filo metallico*



**15-446-090**  
9.0 cm, 3 1/2"

**15-447-090**  
9.0 cm, 3 1/2"

**15-448-110**  
11.0 cm, 4 1/4"

**15-449-110**  
11.0 cm, 4 1/4"

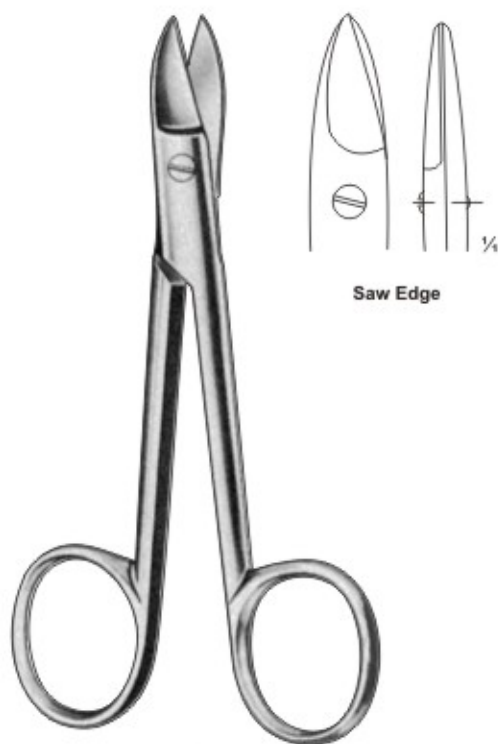

Saw Edge

**BEEBEE**  
**15-450-120**  
12.0 cm, 4 3/4"

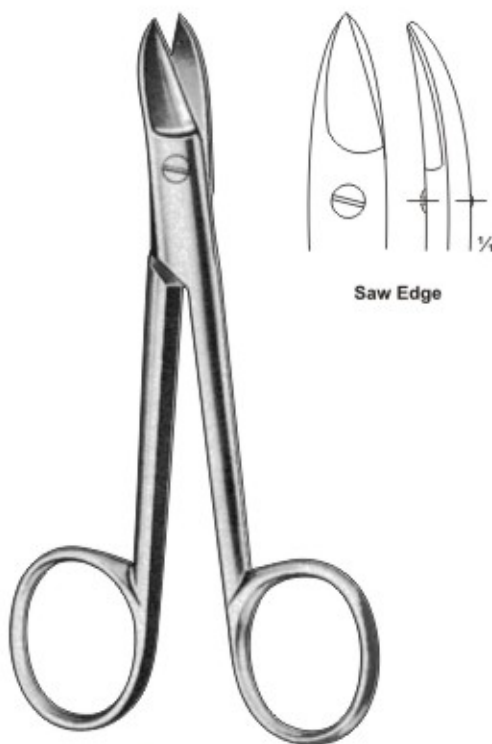

Saw Edge

**BEEBEE**  
**15-451-120**  
12.0 cm, 4 3/4"



**BEEBEE**  
**15-452-105**  
10.5 cm, 4"





## WIRE CUTTING SCISSORS

Drahtscheren  
Tijeras para alambres

Cisailles à fils  
Forbici per filo metallico



**SMITH**  
15-453-175  
17.5 cm, 6 3/4"



Blunt  
15-454-105

Pointed  
15-455-105

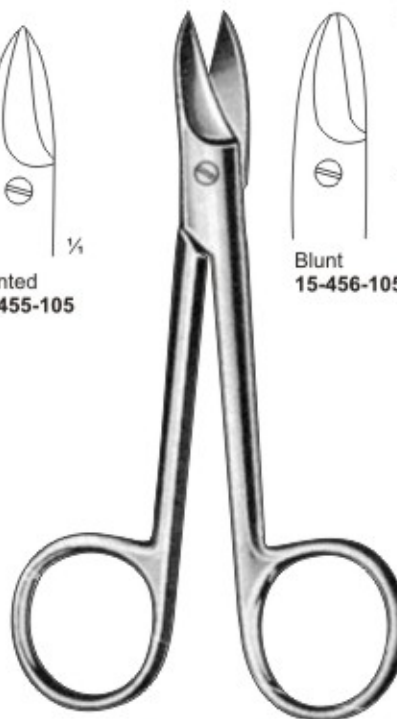

Blunt  
15-456-105

Pointed  
15-457-105



**HARVEY**  
15-458-125  
12.5 cm, 5"

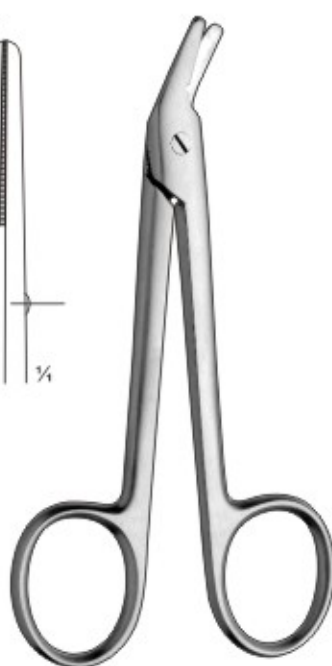

**WIRE CUTTING**  
15-459-115  
11.5 cm, 4 1/2"



**SCHUKNECHT**  
15-460-100  
10.0 cm, 4"



**15-461-110**  
11.0 cm, 4 1/4"

# SCISSORS

Ciseaux  
Forbici



scheren  
Tijeras



**15-462-090**  
9.0 cm, 3 1/2"  
**15-463-105**  
10.5 cm, 4"

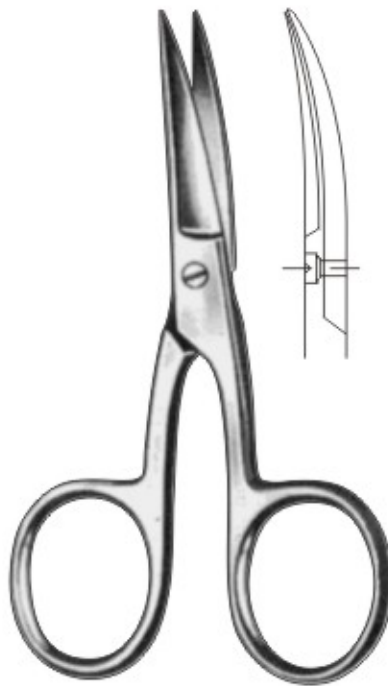

**15-464-090**  
9.0 cm, 3 1/2"  
**15-465-105**  
10.5 cm, 4"



**15-466-090**  
9.0 cm, 3 1/2"  
**15-466-105**  
10.5 cm, 4"



**15-467-130**  
13.0 cm, 5"  
**15-467-155**  
15.5 cm, 6"



**NAIL SCISSORS**  
**15-468-090**  
9 cm, 3 1/2"  
Curved



**NAIL SCISSORS**  
**15-469-090**  
9 cm, 3 1/2"  
Curved



**NAIL SCISSORS**  
**15-470-090**  
9 cm, 3 1/2"  
Arrow Point  
Curved



**15-471-090**  
9.0 cm, 3 1/2"  
**15-472-105**  
10.5 cm, 4"

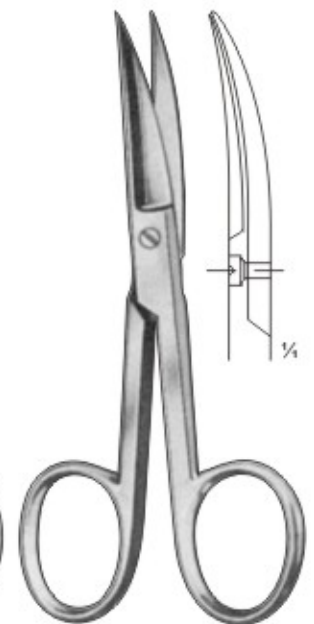

**15-473-090**  
9.0 cm, 3 1/2"  
**15-474-105**  
10.5 cm, 4"



# MICRO SCISSORS

Mikroscheren  
Micro scissors

Micro-Ciseaux  
Micro-Forbici



**CASTROVIEJO**  
9.0 cm, 3 1/2"



15-475-090  
B/B

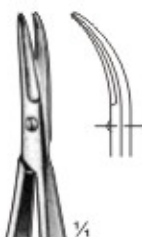

15-476-090  
B/B



15-477-090  
B/S



15-478-090  
S/S

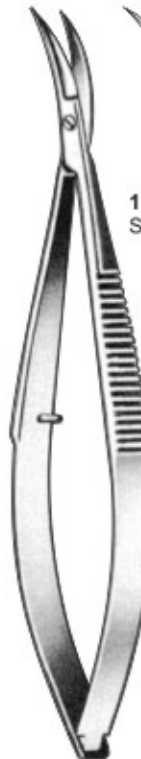

**CASTROVIEJO**  
10.0 cm, 4"



15-479-100  
Sharp



**CASTROVIEJO**  
10.0 cm, 4"



15-480-100  
Blunt



**NOYES**  
A 15-481-120  
B 15-482-120  
C 15-483-120  
12 cm, 4 3/4"



A 1/4" S/S



B 1/4" S/B



C 1/4" B/B



**NOYES**  
15-484-120  
12 cm, 4 3/4"



**WECKER**  
11.0 cm, 4 1/4"



15-485-110  
S/S



15-486-110  
S/B



15-487-110  
B/B



**BARRAQUER**  
15-488-055  
15-489-055  
15-490-055  
5.5 cm, 2 1/4"

# MICRO SCISSORS



Mikroscheren  
Micro scissors

Micro-Ciseaux  
Micro-Forbici



**CASTROVIEJO**  
15-491-110  
11.0 cm, 4 1/4"



**CASTROVIEJO**  
15-492-110  
11.0 cm, 4 1/4"



**TROUTMAN**  
15-493-100  
10.0 cm, 4"



**TROUTMAN**  
15-494-100  
10.0 cm, 4"



**WESTCOTT**  
15-495-110  
11.0 cm, 4 1/4"



**WESTCOTT**  
15-496-110  
11.0 cm, 4 1/4"

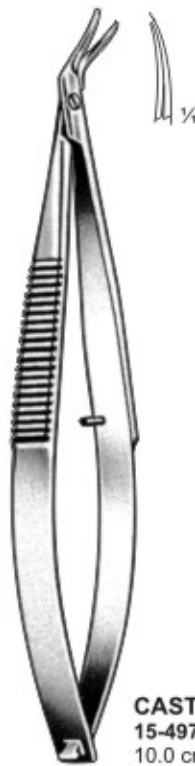

**CASTROVIEJO**  
15-497-100  
10.0 cm, 4"



**CASTROVIEJO**  
15-498-100  
10.0 cm, 4"





# MICRO SCISSORS

Mikroscheren  
Micro scissors

Micro-Ciseaux  
Micro-Forbici



**15-499-120**  
12.0 cm, 4 3/4"





**WESTCOTT**  
**15-500-115**  
11.5 cm, 4 1/2"



**WESTCOTT**  
**15-501-115**  
11.5 cm, 4 1/2"



**WESTCOTT**

	
<b>15-502-110</b> 11 cm, 4 1/4" Curved Sharp/Sharp	<b>15-504-110</b> 11 cm, 4 1/4" Curved Blunt/Blunt
<b>15-503-110</b> 11 cm, 4 1/4" Curved-Micro Sharp/Sharp	



**NOYES**  
**15-505-150**  
15.0 cm, 6"



**15-506-145**  
14.5 cm, 5 3/4"



14 cm

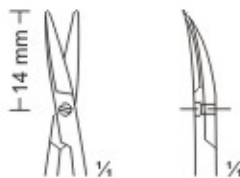

**DISSECTION**  
**15-507-140**

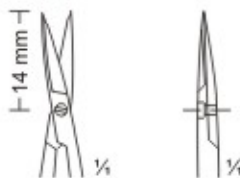

**ADVENTITIA**  
**15-508-140**



**MICRO SCISSOR**  
**15-509-180**  
18 cm, 7"



# MICRO SCISSORS



Mikroscheren  
Micro scissors

Micro-Ciseaux  
Micro-Forbici



**15-510-180**  
18.0 cm, 7" Str.  
**15-511-180**  
18.0 cm, 7" Cvd.



**DISSECTION**  
**15-512-180**  
18 cm, 7" B/B

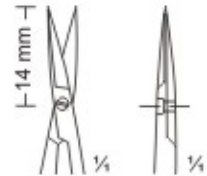

**ADVENTITIA**  
**15-513-180**  
18 cm, 7" S/S



**15-514-145**  
14.5 cm, 5 3/4" Str.  
**15-515-145**  
14.5 cm, 5 3/4" Cvd.



**15-516-180**  
18.0 cm, 7"



# MICRO SCISSORS

Mikroscheren  
Micro scissors

Micro-Ciseaux  
Micro-Forbici



15.0 cm, 6"

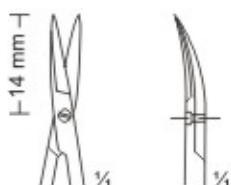

**DISSECTION**  
15-517-150

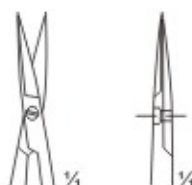

**ADVENTITIA**  
15-518-150

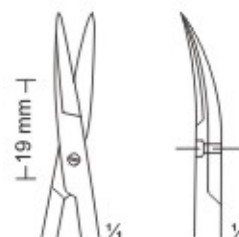

**DISSECTION**  
15-519-150

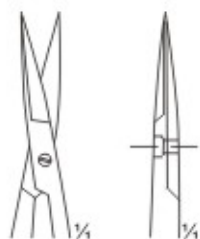

**ADVENTITIA**  
15-520-150

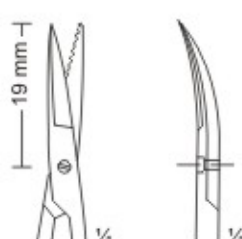

**DISSECTION**  
15-521-150

-Nerve-

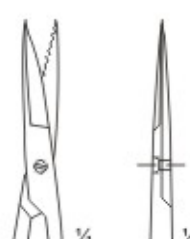

**ADVENTITIA**  
15-522-150



11.0 cm, 4 1/4"

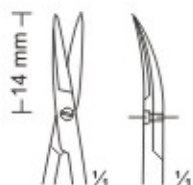

**DISSECTION**  
15-523-110

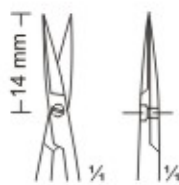

**ADVENTITIA**  
15-524-110



**DISSECTING SCISSORS**  
15-525-110  
11 cm, 4 1/4"

# MICRO SCISSORS



Mikroscheren  
Micro scissors

Micro-Ciseaux  
Micro-Forbici



18.5 cm, 7 1/4"

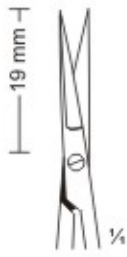

15-526-185  
Str.



15-527-185  
Cvd.



16 cm, 6 1/4"  
20 cm, 8"  
22 cm, 8 3/4"



15-528-160  
15-529-200  
15-530-220



15-531-160  
15-532-200  
15-533-220



15-534-160  
15-535-200  
15-536-220



15-537-160  
15-538-200  
15-539-220



16 cm, 6 1/4"  
20 cm, 8"  
22 cm, 8 3/4"

15-540-160  
15-541-200  
15-542-220



15-543-160  
15-544-200  
15-545-220



18.0 cm, 7"



15-546-180  
25°



15-547-180  
45°



15-548-180  
60°



15-549-180  
90°



15-550-180  
125°



18.0 cm, 7"



15-551-180  
25°



15-552-180  
45°



15-553-180  
60°



15-554-180  
90°



15-555-180  
125°





## PLASTER SCISSORS

Gipsschere  
Tijera para yeso

Ciseaux pour plâtre  
Forbici per gesso



**15-556-200**  
20 cm, 8"



**UNIVERSAL** (Colour Available)  
**15-557-145** 14.5 cm, 5 3/4"  
143 C/290 F Autoclavable  
**15-558-150** 15 cm, 6"  
143 C/290 F Autoclavable  
**15-559-160** 16 cm, 6 1/4"  
143 C/290 F Autoclavable  
**15-560-180** 18 cm, 7"  
143 C/290 F Autoclavable



**UNIVERSAL BANDAGE**  
**15-561-120**  
12 cm, 5"



**ESMARCH**  
**15-562-180**  
18 cm, 7"



**BRUNS**  
**15-564-240**  
24 cm, 9 1/2"  
serrated

**BRUNS**  
**15-563-240**  
24 cm, 9 1/2"  
saw edge



**LISTER**  
**15-565-190**  
Exentric  
19 cm, 7 1/2"



**BERGMANN**  
**15-566-230**  
23 cm, 9"



**ESMARCH**  
**15-567-200**  
20 cm, 8"  
**15-568-220**  
22 cm, 8 3/4"

# PLASTER SCISSORS



Gipsschere  
Tijera para yeso

Ciseaux pour plâtre  
Forbici per gesso



**BRAUN-STADLER**  
15-569-140  
14 cm, 5 1/2"



**BRAUN-STADLER**  
15-570-200  
20 cm, 8"



**MODIFIED-USA**  
15-571-100  
10 cm, 4"

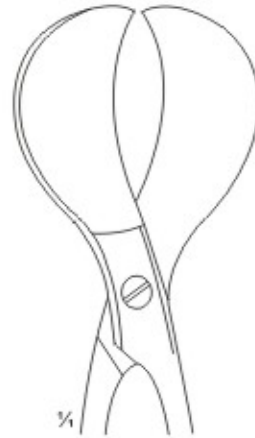

1/4

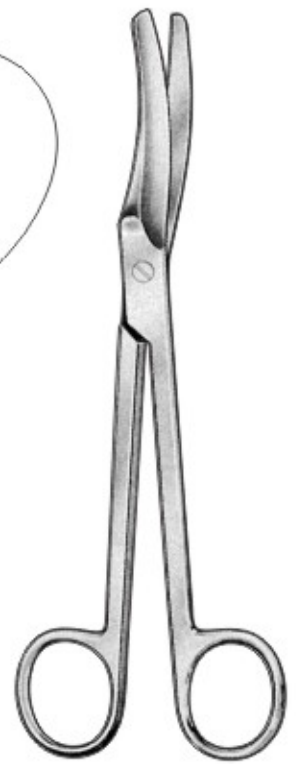

**15-572-200**  
20 cm, 8"



**WALDMANN**  
15-573-180  
18 cm, 7"



1/4



**MARBACH**  
15-574-155  
15.5 cm, 6"



**SCHUMACHER**  
15-575-160  
16 cm, 6 1/4"



**BUSCH**  
15-576-130  
13 cm, 5 1/4"  
15-577-160  
16 cm, 6 1/4"



## PLASTER SCISSORS

Gipsschere  
Tijera para yeso

Ciseaux pour plâtre  
Forbici per gesso



**BERGMANN**  
15-578-180  
18 cm, 7"



15-579-170  
17 cm, 6 3/4"



**BURNHAM BANDAGE**  
15-580-140  
14 cm, 5 1/2"



**SMITH (MOD. USA)**  
15-581-160 16 cm, 6 1/4"  
15-582-180 18 cm, 7"  
15-583-200 20 cm, 8"  
15-584-230 23 cm, 9"



**LORENZ**  
15-585-230  
23 cm, 9"



**KNOWLES**  
15-586-140  
14 cm, 5 1/2"

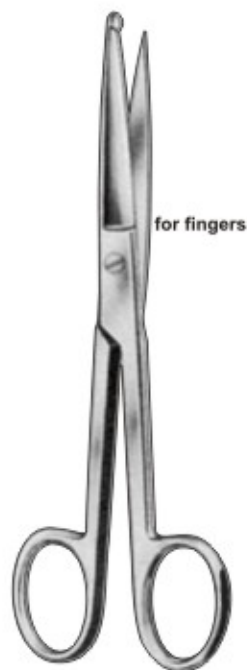

**KNOWLES**  
15-587-210  
14 cm, 5 1/2"



**LISTER**  
15-588-210  
21.0 cm, 8 1/4"

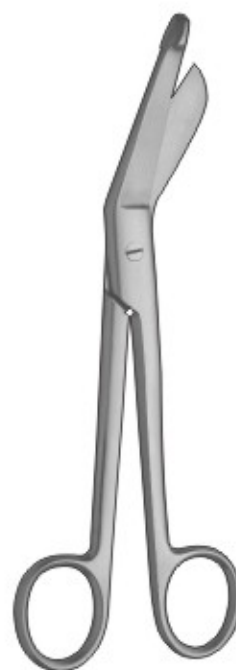

**LISTER BANDAGE**  
15-589-140 14 cm, 5 1/2"  
15-590-160 16 cm, 6 1/4"  
15-591-180 18 cm, 7"  
15-592-200 20 cm, 8"



**LISTER-EXCENTRIC**  
15-593-160 16 cm, 6 1/4"  
15-594-190 19 cm, 7 1/2"

# PLASTER SHEARS



Gipsschere  
Tijera para yeso

Ciseaux pour plâtre  
Forbici per gesso



**STILLE**  
15-595-260  
26 cm, 10 1/4"  
15-596-360  
Spare Blade

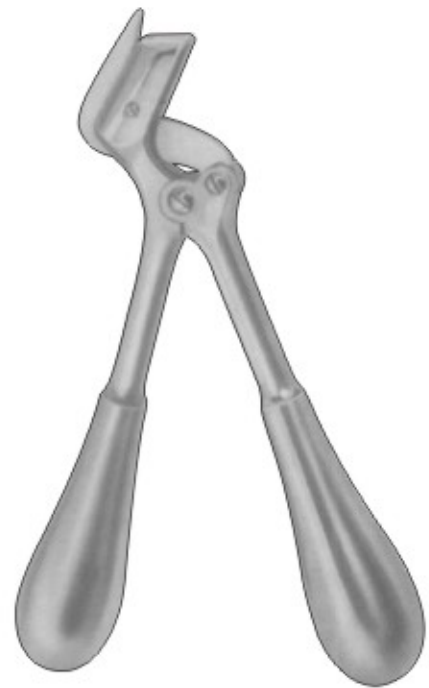

**STILLE**  
15-597-230  
23 cm, 9"  
15-598-230  
Spare blade



**STILLE**  
15-599-370  
37 cm, 14 1/2"  
15-600-370  
Spare blade



**STILLE**  
15-601-240  
24 cm, 9 1/2"  
15-602-240  
Spare blade



## PLASTER SHEARS

Gipsschere  
Tijera para yeso

Ciseaux pour plâtre  
Forbici per gesso



**HENING**  
15-603-270  
27 cm, 10 3/4"

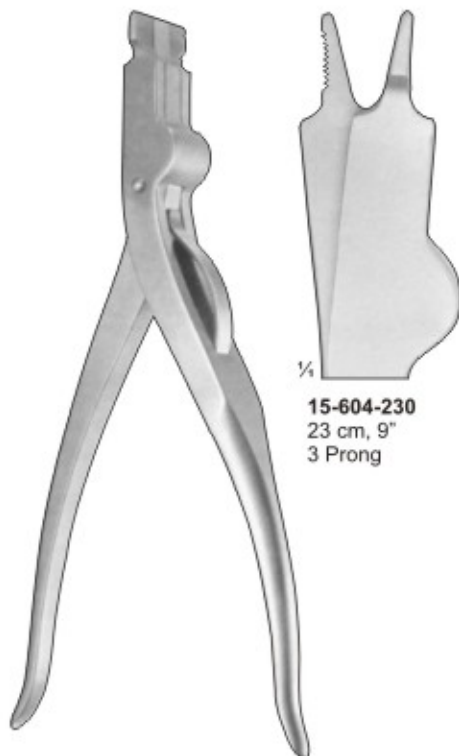

**MODEL USA**

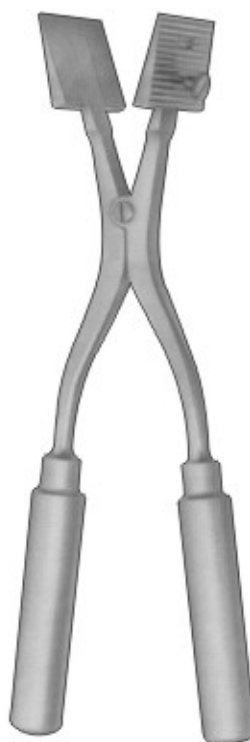

**15-605-290**  
29 cm, 11 1/2"



With removable jaws



**WOLFF**  
15-606-180 18 cm, 7"  
15-607-240 24 cm, 9 1/2"



**ENGEL  
PLASTER SAW**  
15-608-155  
15.5 cm, 6"



**CHARRIERE**  
15-609-250 25 cm, 10"  
15-610-270 27 cm, 10 1/4"  
Double saw

# SUPER CUT SCISSORS

scheren  
Tijeras

Ciseaux  
Forbici



**SAFETY**  
15-611-090 Straight  
15-612-090 Curved  
9.0 cm, 3 1/2"



**GOLDMAN-FOX**  
15-613-090 Straight  
15-614-090 Curved  
9.0 cm, 3 1/2"



**STEVENS TENOTOMY**  
15-615-090 Straight  
15-616-090 Curved  
9.0 cm, 3 1/2"



**STEVENS TENOTOMY**  
15-617-114 Straight  
15-618-114 Curved  
11.4 cm, 4 1/2"



**BABY METZENBAUM**  
15-619-114  
11.4 cm, 4 1/2"  
straight



**BABY METZENBAUM**  
15-620-114  
11.4 cm, 4 1/2"  
Curved



**IRIS**  
15-621-090  
9.0 cm, 3 1/2"  
15-622-114  
11.4 cm, 4 1/2"  
Straight



**IRIS**  
15-623-090  
15-624-090  
9.0 cm, 3 1/2"  
Curved



**IRIS**  
15-625-114  
11.4 cm, 4 1/2"



## SUPER CUT SCISSORS

scheren  
Tijeras

Ciseaux  
Forbici



**METZENBAUM**  
15-626-140 14 cm, 5 1/2"  
15-627-180 18 cm, 7"  
Straight



**METZENBAUM**  
15-628-140 14 cm, 5 1/2"  
15-629-180 18 cm, 7"  
Curved



**METZENBAUM**  
15-630-230 Straight  
15-631-230 Curved  
23 cm, 9"



**METZENBAUM**  
15-632-140  
14 cm, 5 1/2"



**STANDARD**  
15-633-140  
14 cm, 5 1/2"  
Straight



**STANDARD**  
15-634-140  
14 cm, 5 1/2"  
Curved



**METZENBAUM**  
15-635-140 14 cm, 5 1/2"  
15-636-160 16 cm, 6 1/4"  
15-637-180 18 cm, 7"  
15-638-220 20 cm, 8"  
15-639-230 23 cm, 9"  
15-640-280 28 cm, 11"  
15-641-300 30 cm, 11 3/4"

# SUPER CUT SCISSORS



scheren  
Tijeras

Ciseaux  
Forbici



**MAYO**  
15-642-230  
23 cm, 9"  
Straight



**MAYO**  
15-643-230  
23 cm, 9"  
Curved



**JAMISON**  
15-644-140 14.0 cm, 5 1/2"  
15-645-178 17.8 cm, 7"  
Curved



**POTTS-SMITH**  
15-646-178 Angled 25°  
15-647-178 Angled 45°  
15-648-178 Angled 60°  
17.8 cm, 7"



**MAYO**  
15-649-140 14 cm, 5 1/2"  
15-650-150 15 cm, 6"  
15-651-180 18 cm, 7"  
15-652-200 20 cm, 8"  
15-653-230 23 cm, 9"

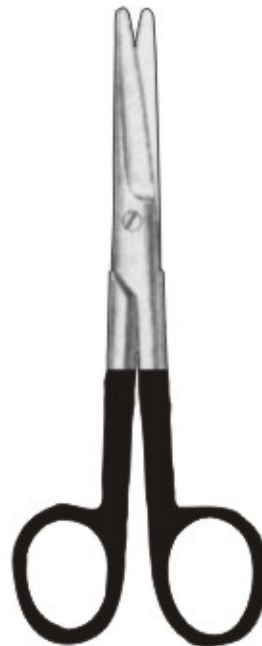

**MAYO**  
15-654-140 14 cm, 5 1/2"  
15-655-170 17 cm, 6 3/4"  
Straight



**MAYO**  
15-656-140 14 cm, 5 1/2"  
15-657-170 17 cm, 6 3/4"  
Curved





## OPERATING SCISSORS T.C. INSERTED

Chirurgische scheren  
Tijeras quirúrgicas

Ciseaux chirurgicaux  
Forbici per chirurgia



**STANDARD**

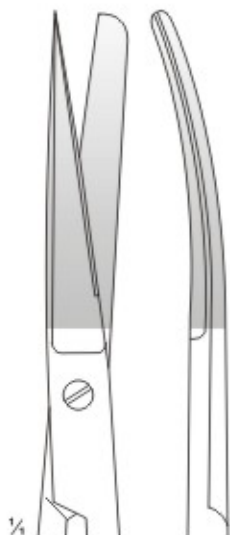

**15-658-145**  
14.5 cm, 5 3/4" Straight  
**15-659-145**  
14.5 cm, 5 3/4" Curved

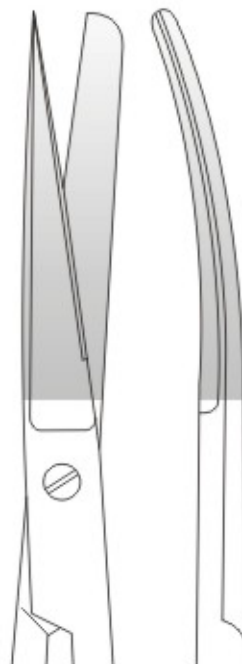

**15-660-165**  
16.5 cm, 6 1/2" Straight  
**15-661-165**  
16.5 cm, 6 1/2" Curved

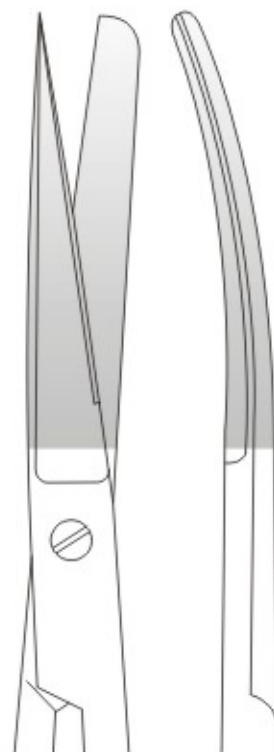

**15-662-185**  
18.5 cm, 7 1/4" Straight  
**15-663-185**  
18.5 cm, 7 1/4" Curved



**STANDARD**

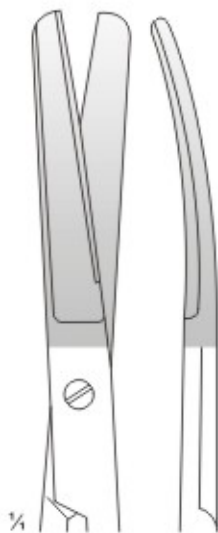

**15-664-145**  
14.5 cm, 5 3/4" Straight  
**15-665-145**  
14.5 cm, 5 3/4" Curved



**15-666-165**  
16.5 cm, 6 1/2" Straight  
**15-667-165**  
16.5 cm, 6 1/2" Curved

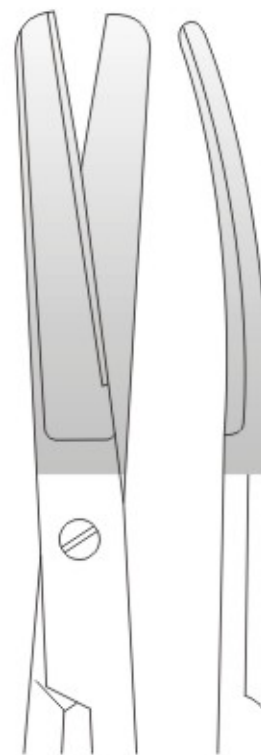

**15-668-185**  
18.5 cm, 7 1/4" Straight  
**15-669-185**  
18.5 cm, 7 1/4" Curved

# OPERATING SCISSORS T.C. INSERTED

Chirurgische scheren  
Tijeras quirúrgicas

Ciseaux chirurgicaux  
Forbici per chirurgia

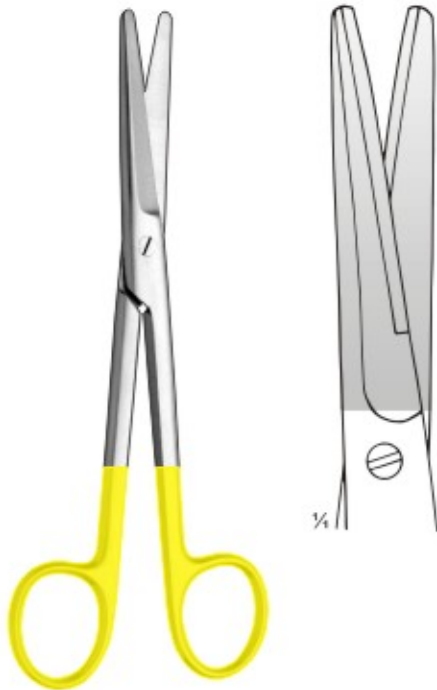

**MAYO**  
**15-670-140** 14 cm, 5 1/2"  
**15-671-170** 17 cm, 6 3/4"  
**15-672-230** 23 cm, 9"  
 blunt/blunt

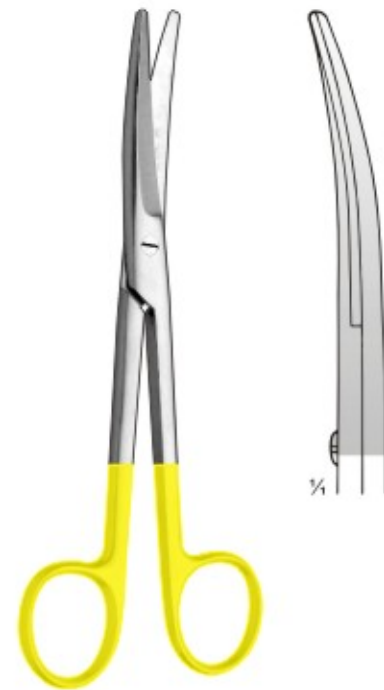

**MAYO**  
**15-673-140** 14 cm, 5 1/2"  
**15-674-170** 17 cm, 6 3/4"  
**15-675-230** 23 cm, 9"  
 blunt/blunt, Cvd.



**STANDARD**

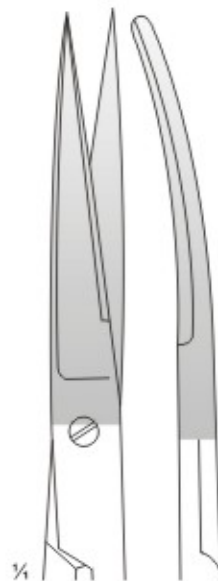

**15-676-145**  
 14.5 cm, 5 3/4" Straight  
**15-677-145**  
 14.5 cm, 5 3/4" Curved

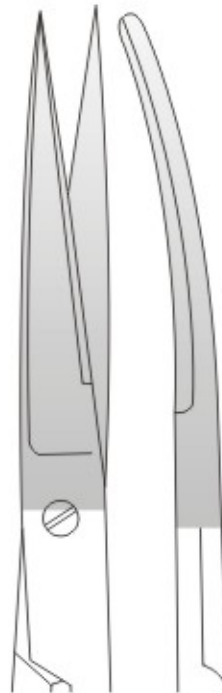

**15-678-165**  
 16.5 cm, 6 1/2" Straight  
**15-679-165**  
 16.5 cm, 6 1/2" Curved

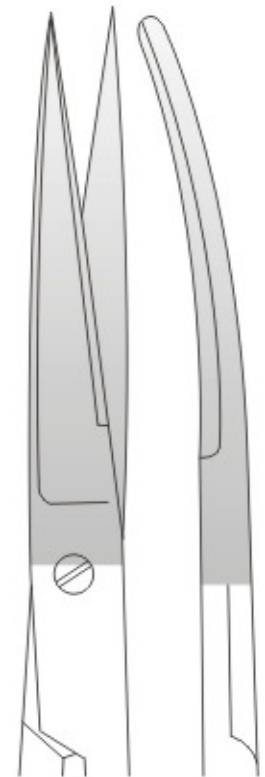

**15-680-185**  
 18.5 cm, 7 1/4" Straight  
**15-681-185**  
 18.5 cm, 7 1/4" Curved



## OPERATING SCISSORS T.C. INSERTED

Chirurgische scheren  
Tijeras quirúrgicas

Ciseaux chirurgicaux  
Forbici per chirurgia



### MAYO-STILLE

15-682-150 15 cm, 6"  
15-683-170 17 cm, 6 3/4"  
blunt/blunt, Cvd.

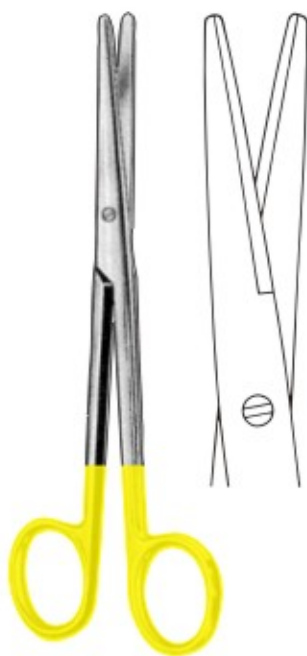

### LEXER

15-684-160 16 cm, 6 1/4"  
15-685-215 21.5 cm, 8 1/2"  
blunt/blunt, Str.



### LEXER

15-686-160 16 cm, 6 1/4"  
15-687-215 21.5 cm, 8 1/2"  
blunt/blunt, Cvd.



### PARAMETRIUM

23 cm, 9"



15-688-230  
blunt/blunt, Str.



15-689-230  
blunt/blunt, Cvd.

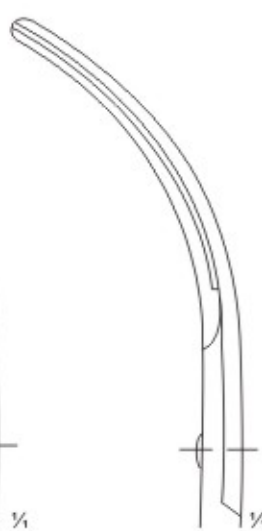

15-690-230  
blunt/blunt, Full Cvd.

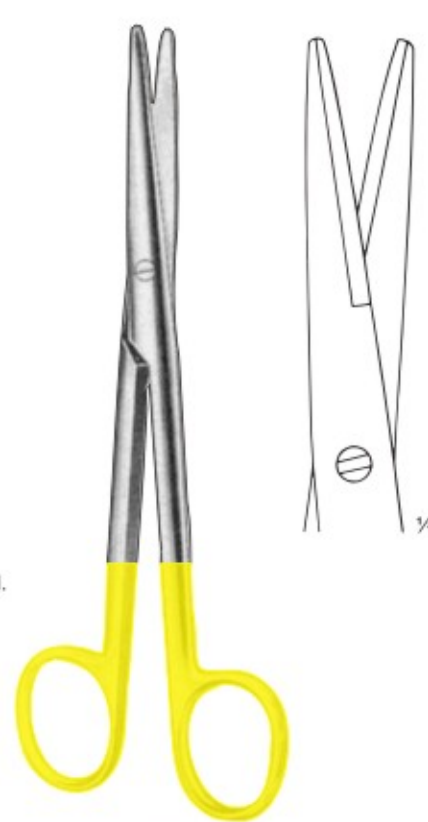

### MAYO-STILLE

15-691-150 15 cm, 6"  
15-692-170 17 cm, 6 3/4"  
blunt/blunt, Str.

# OPERATING SCISSORS T.C. INSERTED

Chirurgische scheren  
Tijeras quirúrgicas

Ciseaux chirurgicaux  
Forbici per chirurgia



**GOLDMAN-FOX**  
15-693-130  
13.0 cm, 5"



**GOLDMAN-FOX**  
15-694-130  
13.0 cm, 5"



**SIMS**  
15-695-230  
23.0 cm, 9"  
Straight



**SIMS**  
15-696-230  
23.0 cm, 9"  
Curved

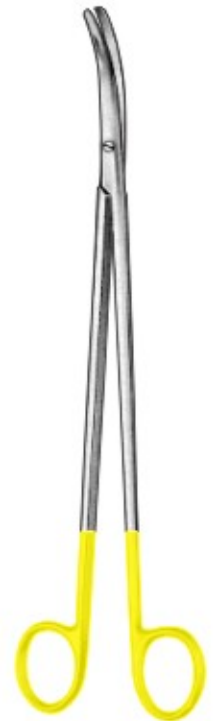

**CARDINALE**  
15-697-280  
28.0 cm, 11"



## DISSECTING SCISSORS T.C. INSERTED

Präparierscheren  
Tijeras de disección

Ciseaux à dissection  
Forbici per dissezione



**15-698-180**  
14.5 cm, 5 3/4"



**15-699-180**  
18.0 cm, 7"



**15-700-200**  
20.0 cm, 8"



**15-701-230**  
23.0 cm, 9"



**15-702-250**  
25.0 cm, 10"



**15-703-280**  
28.0 cm, 11"

**METZENBAUM**  
**DELICATE**  
Blunt / Blunt  
Curved



**15-704-145**  
14.5 cm, 5 3/4"



**15-705-180**  
18.0 cm, 7"



**15-706-200**  
20.0 cm, 8"

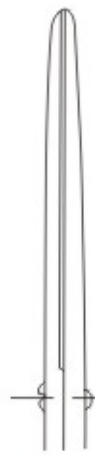

**15-707-230**  
23.0 cm, 9"



**15-708-250**  
25.0 cm, 10"

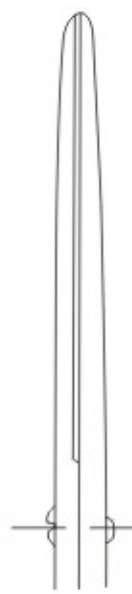

**15-709-280**  
28.0 cm, 11"

**METZENBAUM**  
**DELICATE**  
Blunt / Blunt  
Straight

# DISSECTING SCISSORS T.C. INSERTED

Präparierscheren  
Tijeras de disección

Ciseaux à dissection  
Forbici per dissezione



15-710-180  
14.5 cm, 5 3/4"



15-711-180  
18.0 cm, 7"



15-712-200  
20.0 cm, 8"



15-713-230  
23.0 cm, 9"



15-714-250  
25.0 cm, 10"

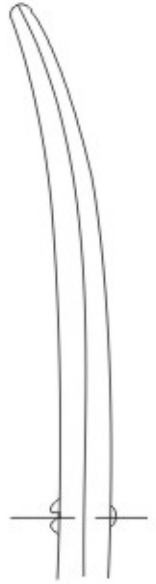

15-715-280  
28.0 cm, 11"

**METZENBAUM  
DELICATE**  
Sharp / Sharp  
Curved



15-716-145  
14.5 cm, 5 3/4"



15-717-180  
18.0 cm, 7"



15-718-200  
20.0 cm, 8"

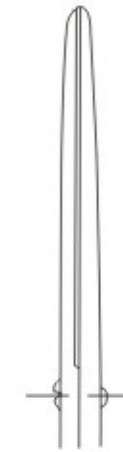

15-719-230  
23.0 cm, 9"



15-720-250  
25.0 cm, 10"



15-721-280  
28.0 cm, 11"

**METZENBAUM  
DELICATE**  
Sharp / Sharp  
Straight



## OPERATING, DISSECTING SCISSORS T.C. INSERTED

Chirurgische scheren, Präparierscheren  
Tijeras quirúrgicas, Tijeras de disección

Ciseaux chirurgicaux, Ciseaux à dissection  
Forbici per chirurgia, Forbici per dissezione

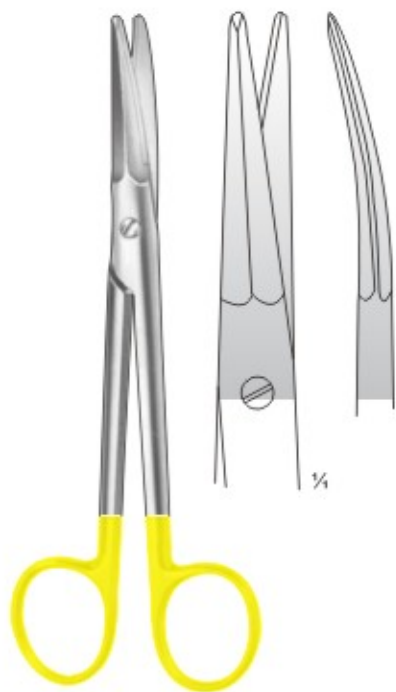

**REES**  
15-722-180  
18 cm, 7"

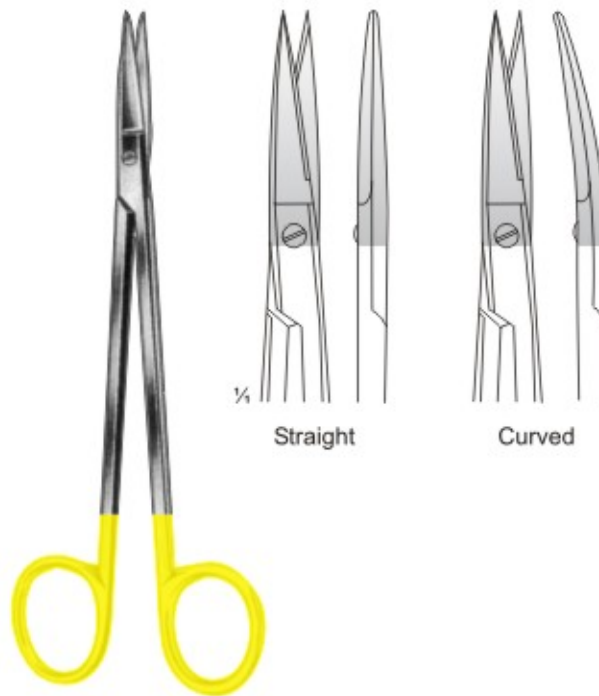

**KELLY**  
15-723-160  
15-724-160  
16 cm, 6 1/4"

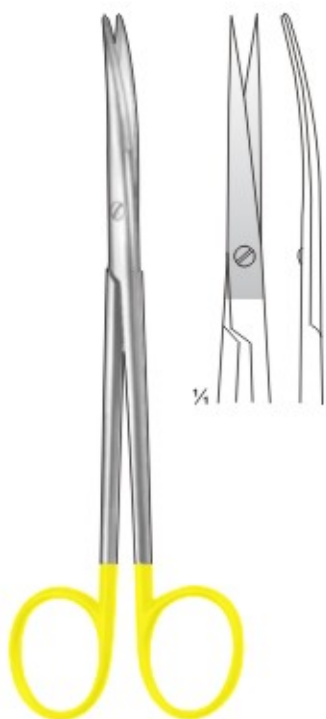

**METZENBAUM-LAHEY**  
15-725-140 14.0 cm, 5 1/2" Sharp/Sharp  
15-726-205 20.5 cm, 8" Blunt/Blunt  
15-727-230 23.0 cm, 9" Blunt/Blunt



**METZENBAUM-LAHEY**  
15-728-180 18.0 cm, 7" Str.  
15-729-205 20.5 cm, 8" Cvd.  
15-730-230 23.0 cm, 9" Cvd.

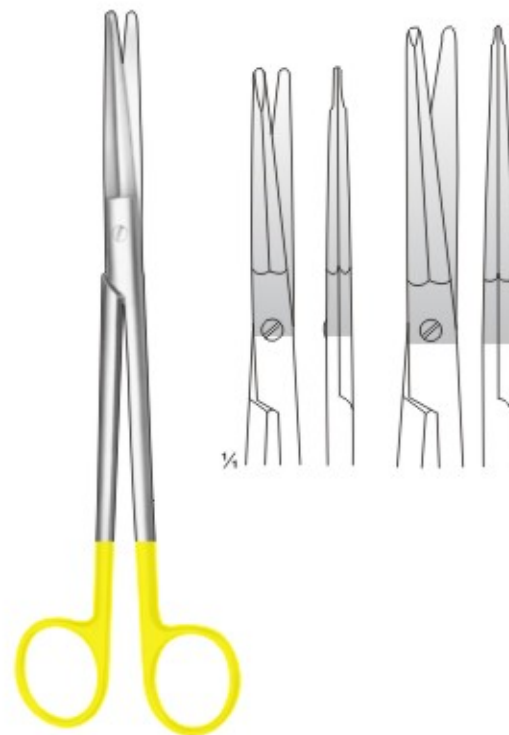

**GORNEY**  
15-731-200 20 cm, 8"  
15-732-230 23 cm, 9"

# VASCULAR, DISSECTING & PLASTER SCISSORS T.C. INSERTED



Gefäßscheren, Präparierscheren, Gipsschere  
 Tijeras vasculares, Tijeras de disección, Tijera para yeso

Ciseaux vasculaires, Ciseaux à dissection, Ciseaux pour plâtre  
 Forbici vascolari, Forbici per dissezione, Forbici per gesso

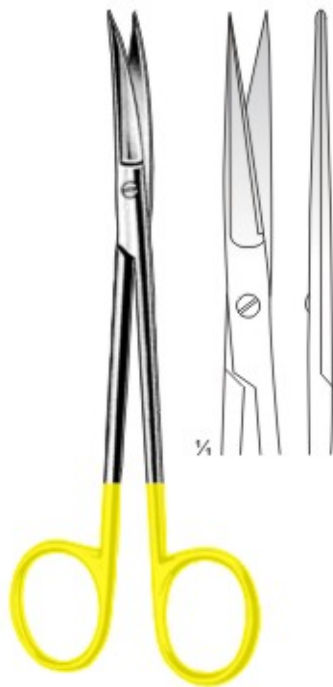

**JOSEPH**  
 15-733-145  
 14.5 cm, 5 3/4"

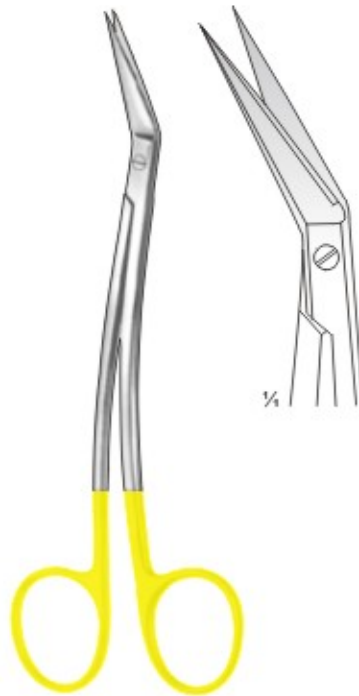

**GUM SCISSORS**  
 Locklin  
 15-734-160  
 16 cm, 6 1/4"

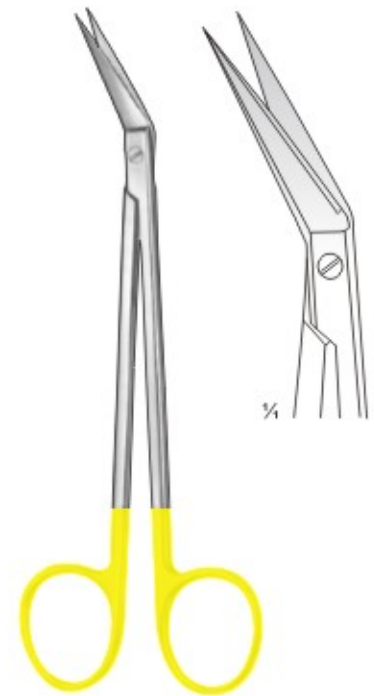

**GUM SCISSORS**  
 Locklin  
 15-735-160  
 16 cm, 6 1/4"



**RAGNELL**  
 15-736-125  
 12.5 cm, 5"

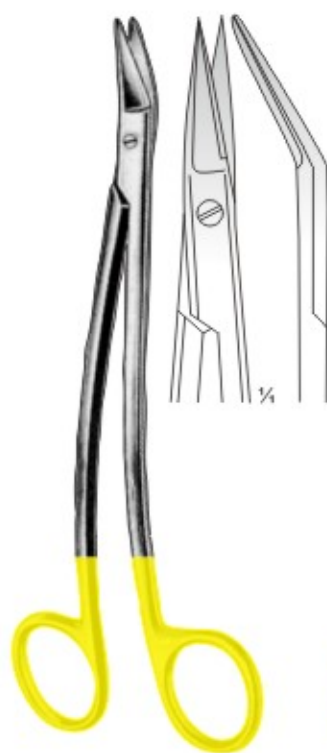

**DEAN**  
 15-737-175  
 17.5 cm, 6 3/4"

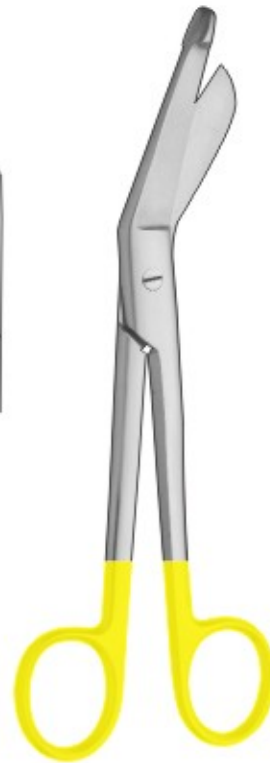

**LISTER BANDAGE**  
 15-738-140 14 cm, 5 1/2"  
 15-739-160 16 cm, 6 1/4"  
 15-740-180 18 cm, 7"  
 15-741-200 20 cm, 8"

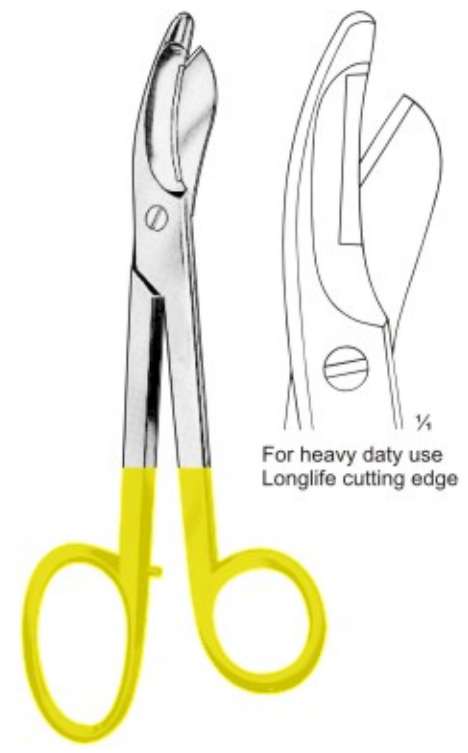

**BRUNS SCISSORS**  
 15-742-210  
 21 cm, 8 1/4"





## VASCULAR, DISSECTING SCISSORS T.C. INSERTED

Gefäßscheren, Präparierscheren  
Tijeras vasculares, Tijeras de disección

Ciseaux vasculaires, Ciseaux à dissection  
Forbici vascolari, Forbici per dissezione



**DEBAKEY**



**15-743-165**  
16.5 cm 6 1/2"



**15-744-180**  
18.0 cm 7"

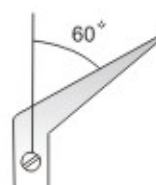

**15-745-185**  
18.5cm 7 1/4"

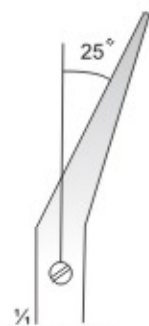

**15-746-190**  
19.0 cm 7 1/2"

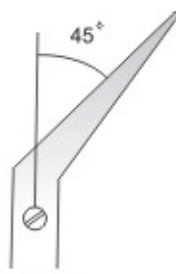

**15-747-220**  
22.0 cm 8 3/4"

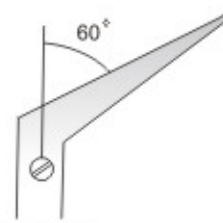

**15-748-230**  
23.0 cm 9"



**POTTS-SMITH**  
19.0 cm, 7 1/2"



**25°**  
**15-749-190**



**45°**  
**15-750-190**



**60°**  
**15-751-190**



**IRIS**  
**15-752-110**  
11cm 4 1/2"

# IRIS SCISSORS T.C. INSERTED



Irisscheren  
Tijeras para Iridectomía

Ciseaux à iridectomie  
Forbici per iridectomia

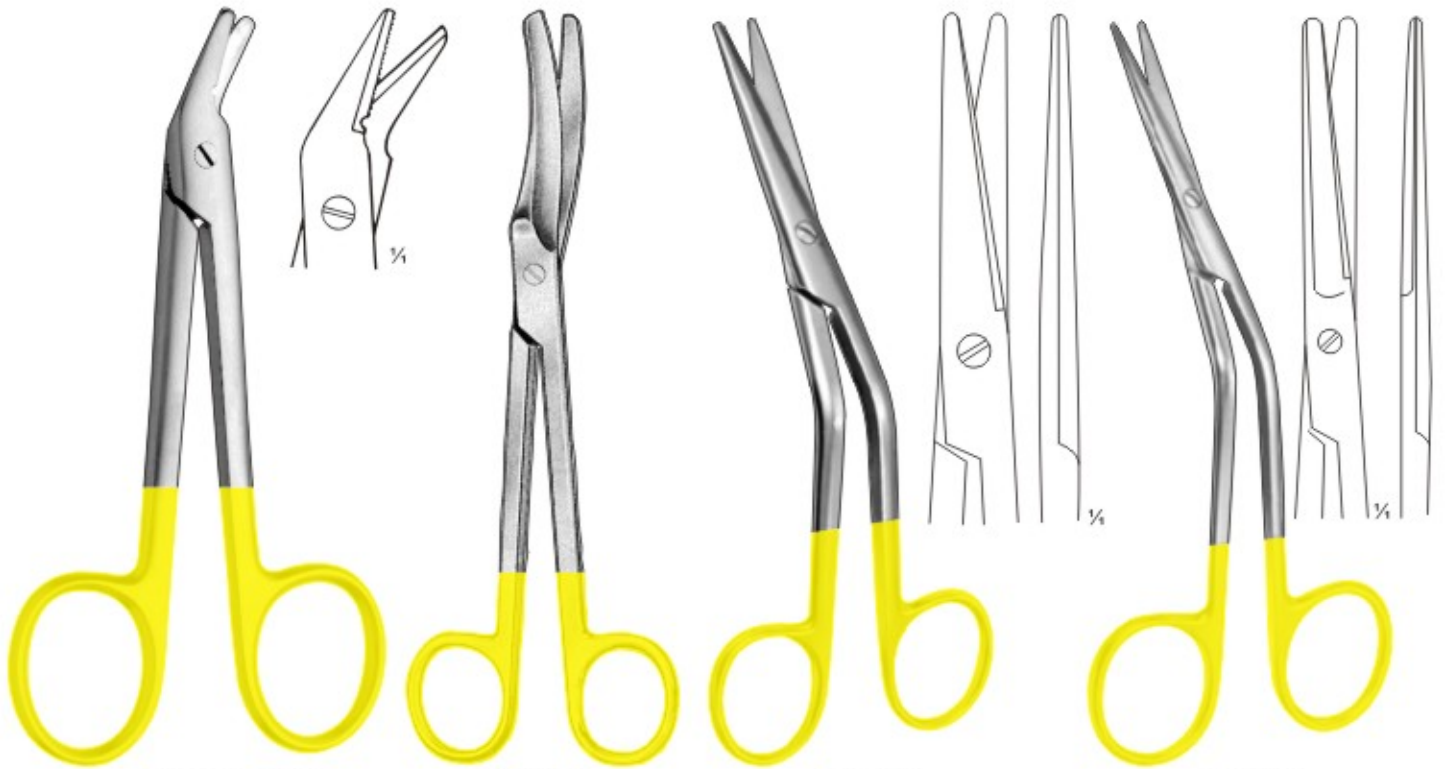

**WIRE CUTTING**  
15-753-115  
11.5 cm, 4 1/2"

15-754-200  
20.0 cm, 8"

**FOMON**  
15-755-145  
14.5cm, 5 3/4"

**COTTLE**  
15-756-160  
16 cm, 6 1/4"



**IRIS**  
15-757-115  
11.5cm 4 1/2"

**IRIS**  
15-758-115  
11.5 cm Straight  
15-759-115  
11.5 cm Curved

**TOENNIS-ADSON**  
15-760-175  
17.5 cm, 6 3/4"

**STRABISMUS**  
15-761-115  
11.5 cm, 4 1/2"  
Curved



## **DRESSING & TISSUE FORCEPS**

---

- **DRESSING FORCEPS**
- **MICRO FORCEPS**
- **CILIA FORCEPS**

- **TISSUE FORCEPS**
- **SPLINTER FORCEPS**

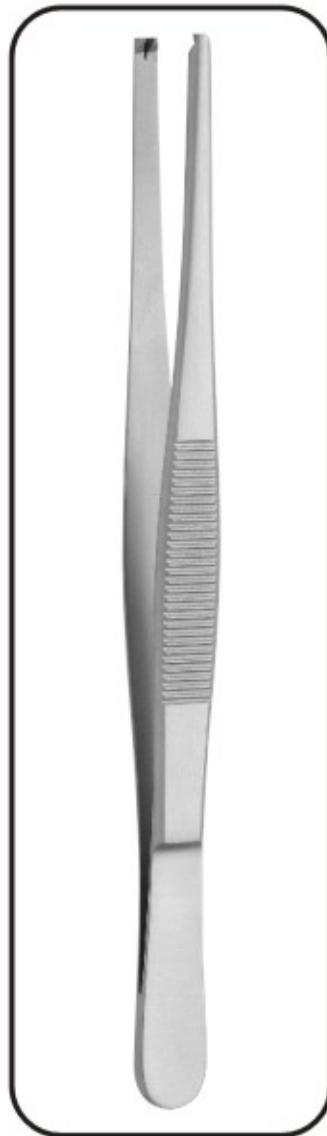
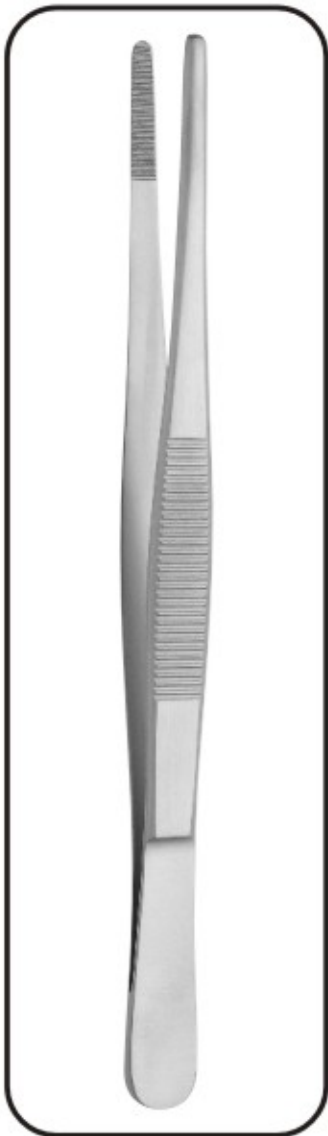

# TISSUE & DRESSING FORCEPS



Pinces a tissu, Anatomische pinzetten  
Gewebe, Pinzas de disección

Pinzas para tejidos, Pinces à dissection  
Pinze per tessuti, Pinze per dissezione



 ¼  
**16-001-105**  
10.5 cm, 4"

 ¼  
**16-002-115**  
11.5 cm 4 ½"

 ¼  
**16-003-125**  
12.5 cm 5"

 ¼  
**16-004-140**  
14.0 cm, 5 ½"

 ¼  
**16-005-160**  
16.0 cm 6 ¼"

 ¼  
**16-006-180**  
18.0 cm, 7"

 ¼  
**16-007-200**  
20.0 cm, 8"

 ¼  
**16-008-250**  
25.0 cm. 10"

 ¼  
**16-009-300**  
30.0 cm, 12"

1:2  
STANDARD





 ¼  
**16-010-105**  
10.5 cm, 4"

 ¼  
**16-011-115**  
11.5 cm, 4 ½"

 ¼  
**16-012-125**  
12.5 cm, 5"

 ¼  
**16-013-140**  
14.0 cm, 5 ½"

 ¼  
**16-014-160**  
16.0 cm 6 ¼"

 ¼  
**16-015-180**  
18.0 cm, 7"

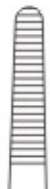
 ¼  
**16-016-200**  
20.0 cm, 8"

 ¼  
**16-017-250**  
25.0 cm, 10"

 ¼  
**16-018-300**  
30.0 cm, 12"

STANDARD



# DRESSING FORCEPS

Anatomische pinzetten  
Pinzas de disección

Pinces à dissection  
Pinze per dissezione



Mod.  
USA

## STANDARD

16-019-120	12.0 cm, 4.5"
16-020-130	13.0 cm, 5"
16-021-145	14.5 cm, 5.5"
16-022-155	15.5 cm, 6"
16-023-180	18.0 cm, 7"
16-024-210	21.0 cm, 8"
16-025-250	25.0 cm, 10"
16-026-310	31.0 cm, 12"



Mod.  
USA

## STANDARD

16-027-120	12.0 cm, 4.5"
16-028-130	13.0 cm, 5"
16-029-145	14.5 cm, 5.5"
16-030-155	15.5 cm, 6"
16-031-180	18.0 cm, 7"
16-032-210	21.0 cm, 8"
16-033-250	25.0 cm, 10"
16-034-310	31.0 cm, 12"



¼

## STILLE

16-035-150	15.0 cm, 6"
------------	-------------



## MOD. MARTIN

16-036-130	13.0 cm, 5"
16-037-145	14.5 cm, 5.5"



## STANDARD STRAIGHT

16-038-115	11.5 cm, 4.5"
16-039-130	13.0 cm, 5"
16-040-145	14.5 cm, 5.5"
16-041-160	16.0 cm, 6"
16-042-180	18.0 cm, 7"
16-043-200	20.0 cm, 8"
16-044-250	25.0 cm, 10"
16-045-300	30.0 cm, 11.5"



## STANDARD CURVED

16-046-115	11.5 cm, 4.5"
16-047-130	13.0 cm, 5"
16-048-145	14.5 cm, 5.5"
16-049-160	16.0 cm, 6"
16-050-180	18.0 cm, 7"
16-051-200	20.0 cm, 8"



## STANDARD

wide pattern cross serration	
16-052-130	13.0 cm, 5"
16-053-145	14.5 cm, 5.5"
16-054-180	18.0 cm, 7"



## STANDARD NARROW

16-055-130	13.0 cm, 5"
16-056-145	14.5 cm, 5 ½"

# DRESSING FORCEPS



Anatomische pinzetten  
Pinzas de disección

Pinces à dissection  
Pinze per dissezione



**SEMKEN**  
16-057-125 12.5 cm, 5"  
16-058-155 15.5 cm, 6"

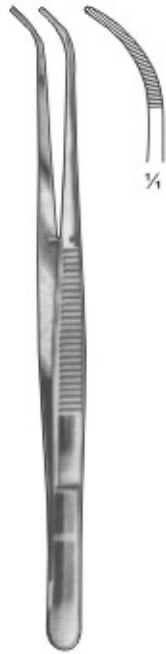

**SEMKEN**  
16-059-125 12.5 cm, 5"  
16-060-155 15.5 cm, 6"



**TAYLOR**  
16-061-175  
17.5 cm 7"



**TAYLOR**  
16-062-175  
17.5 cm 7"



**TAYLOR**  
16-063-175  
17.5 cm 7"



**TAYLOR**  
16-064-175  
17.5 cm 7"



**GERALD**  
16-065-180  
18 cm, 7"

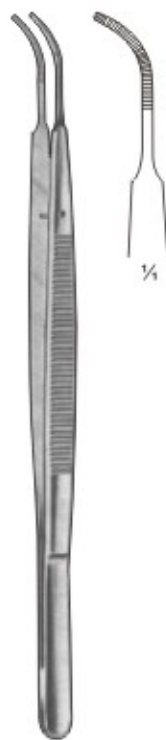

**GERALD**  
16-066-180  
18 cm, 7"



**CUSHING**  
16-067-175  
17.5 cm, 7"



**CUSHING**  
16-068-175  
17.5 cm, 7"



## TISSUE & DRESSING FORCEPS

*Pinces a tissu, Anatomische pinzetten  
Gewebe, Pinzas de disección*

*Pinzas para tejidos, Pinces à dissection  
Pinze per tessuti, Pinze per dissezione*



**CUSHING 1:2**  
16-069-175  
17.5 cm, 7"



**CUSHING 1:2**  
16-070-175  
17.5 cm, 7"



**POTTS-SMITH 1:2**  
16-071-180 18 cm, 7"  
16-072-210 21 cm, 8"  
16-073-250 25 cm, 10"



**POTTS-SMITH 1:2**  
16-074-180 18 cm, 7"  
16-075-210 21 cm, 8"  
16-076-250 25 cm, 10"



**BROPHY 1:2**  
16-077-200  
20 cm, 8"

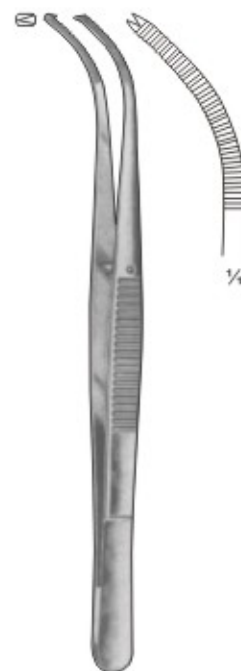

**BROPHY 1:2**  
16-078-200  
20 cm, 8"



**POTTS-SMITH**  
16-079-180 18 cm, 7"  
16-080-210 21 cm, 8.5"  
16-081-250 25 cm, 10"



**POTTS-SMITH**  
16-082-180 18 cm, 7"  
16-083-210 21 cm, 8.5"  
16-084-250 25 cm, 10"



**BROPHY**  
16-085-200  
20 cm, 8"



**BROPHY**  
16-086-200  
20 cm, 8"



**WANGENSTEEN**  
16-087-230  
23 cm, 9"



**GERALD 1:2**  
16-088-170  
17 cm, 6.75"



**GERALD 1:2**  
16-089-170  
17 cm, 6.75"

# TISSUE FORCEPS



Pinces a tissu,  
Gewebe Pinzas

Pinzas para tejidos,  
Pinze per tessuti



**SEMKEN 1:2**  
16-090-125 12.5 cm, 5"  
16-091-150 15.0 cm, 6"



**SEMKEN 1:2**  
16-092-125 12.5 cm, 5"  
16-093-150 15.0 cm, 6"



**TAYLOR 1:2**  
16-094-175 17.5 cm, 7"



**TAYLOR 1:2**  
16-095-175 17.5 cm, 7"



**TAYLOR 1:2**  
16-096-175 17.5 cm, 7"



**TAYLOR 1:2**  
16-097-175 17.5 cm, 7"

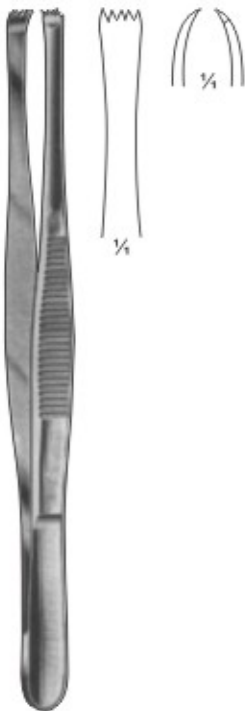

**STONE 4:5**  
16-098-150 15 cm, 6"

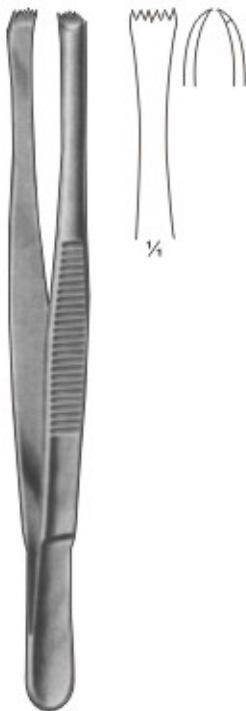

**LERCHE 5:6**  
16-099-150 15 cm, 6"



**ADLERKREUTZ 2:3**  
16-100-150 15 cm, 6"  
16-101-200 20 cm, 8"



**ADLERKREUTZ 4:5**  
16-102-150 15 cm, 6"  
16-103-200 20 cm, 8"



**GILLIES 1:2**  
16-104-150 15 cm, 6"





# TISSUE FORCEPS

*Pinces a tissu,  
Gewebe Pinzas*

*Pinzas para tejidos,  
Pinze per tessuti*



2:3

**16-105-115** 11.5 cm 4 1/2"  
**16-106-130** 13.0 cm 5"  
**16-107-145** 14.5 cm 5 1/2"  
**16-108-160** 16.0 cm 6 1/4"  
**16-109-180** 18.0 cm 7"  
**16-110-200** 20.0 cm 8"  
**16-111-250** 25.0 cm 10"  
**16-112-300** 30.0 cm 12"



3:4

**16-113-130** 13 cm, 5"  
**16-114-145** 14.5 cm, 5 1/2"  
**16-115-160** 16 cm, 6 1/4"



4:5

**16-116-130** 13 cm, 5"  
**16-117-145** 14.5 cm, 5 1/2"  
**16-118-160** 16 cm, 6 1/4"



1:2

**16-119-130** 13 cm, 5"  
**16-120-145** 14.5cm, 5 1/2"  
**16-121-160** 16 cm, 6 1/4"  
**16-122-200** 20 cm, 8"



1:2

**16-123-130** 13 cm, 5"  
**16-124-145** 14.5 cm, 5 1/2"



1:2

**16-125-130** 13 cm, 5"  
**16-126-145** 14.5 cm, 5 1/2"



1:2

**STILLE 1:2**  
**16-127-150** 15 cm, 6"



2:3

**STILLE 2:3**  
**16-128-150** 15 cm, 6"



1:2

**16-129-120** 12 cm, 4 3/4"  
**16-130-130** 13 cm, 5"  
**16-131-145** 14.5cm, 5 1/2"  
**16-132-155** 15.5cm, 6"  
**16-133-185** 18.5cm, 7 1/4"  
**16-134-210** 21 cm, 8 1/4"  
**16-135-250** 25 cm, 10"  
**16-136-300** 30 cm, 12 1/4"



2:3

**MOD. USA**  
**16-137-130** 13. cm, 5"  
**16-138-145** 14.5cm, 5 1/2"  
**16-139-155** 15.5cm, 6"



3:4

**16-140-130** 13 cm, 5"  
**16-141-145** 14.5cm, 5 1/2"  
**16-142-155** 15.5cm, 6"



4:5

**16-143-130** 13 cm, 5"  
**16-144-145** 14.5cm, 5 1/2"  
**16-145-155** 15.5cm, 6"

# TISSUE & DRESSING FORCEPS



*Pinces a tissu, Anatomische pinzetten  
Gewebe, Pinzas de disección*

*Pinzas para tejidos, Pinces à dissection  
Pinze per tessuti, Pinze per dissezione*



**MCINDOE**  
16-146-150 15.0 cm, 6"  
Dissecting Forceps  
non-toothed,  
serrated jaws.

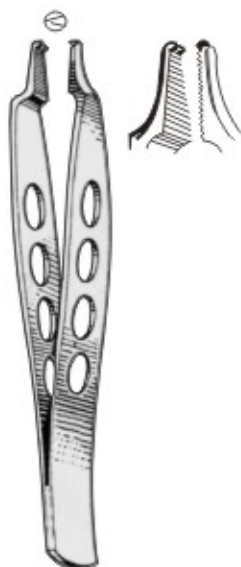

**JEAN 1:2**  
16-147-140 14.0 cm, 5 1/2"  
16-148-180 18.0 cm, 7"  
Dissecting Forceps  
one into two teeth on  
serrated jaws.



**WUAUGH 1:2**  
16-149-150 15.0 cm, 6"  
16-150-180 18.0 cm, 7"  
Dissecting Forceps  
slightly heavier  
non-toothed,  
serrated jaws.



**WUAUGH 1:2**  
16-151-150 15.0 cm, 6"  
16-152-180 18.0 cm, 7"  
Dissecting Forceps  
as above but one  
two tooth on  
serrated jaws.  
Known as Scott.



**LEEDHAM 1:2**  
16-153-145 14.5 cm, 5.75"  
16-154-180 18.0 cm, 7"  
Green Dissecting  
Forceps  
two three teeth, smooth jaws.



**TREVES 1:2**  
16-155-125 12.5 cm, 5"  
16-156-150 15.0 cm, 6"  
16-157-180 18.0 cm, 7"  
Dissecting Forceps  
teeth, on smooth jaws.



**CHARNLEY 1:2**  
16-158-145 14.5 cm, 5 3/4"  
16-159-180 18.0 cm, 7"  
Dissecting Forceps  
one into two teeth,  
block on jaws.



**RAMSAY**  
16-160-180 18.0 cm, 7"  
Dissecting Forceps  
non-toothed serrated jaws.



**RAMSAY 1:2**  
16-161-180 18.0 cm, 7"  
Dissecting Forceps  
one into teeth on  
serrated jaws.  
As above but into  
three teeth.



16-162-125 12.5 cm, 5"  
16-163-150 15.0 cm, 6"  
16-164-180 18.0 cm, 7"  
Dissecting Forceps  
turn over end,  
serrated jaws.



16-165-125 12.5 cm, 5"  
16-166-150 15.0 cm, 6"  
16-167-180 18.0 cm, 7"  
16-168-200 20.0 cm, 8"  
Dissecting Forceps  
block end, serrated  
jaws.



# TISSUE FORCEPS

Pinces a tissu  
Gewebe Pinzas

Pinzas para tejidos  
Pinze per tessuti



**FERRIS-SMITH 1:2**  
16-169-180  
18 cm, 7"



**FERRIS-SMITH 1:2**  
16-170-180  
18 cm, 7"



**LANE 1:2**  
16-171-125 12.5cm, 5 1/2"  
16-172-150 15 cm, 6"  
16-173-170 17 cm, 6 3/4"  
16-174-180 18 cm, 7"  
16-175-200 20 cm, 8"



**LANE 2:3**  
16-176-125 12.5cm, 5 1/2"  
16-177-150 15 cm, 6"  
16-178-170 17 cm, 6 3/4"  
16-179-180 18 cm, 7"  
16-180-200 20 cm, 8"

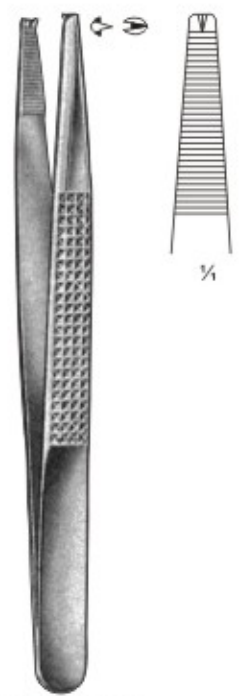

**BONNEY 1:2**  
16-181-180  
18 cm, 7"



**BONNEY 2:3**  
16-182-180  
18 cm, 7"

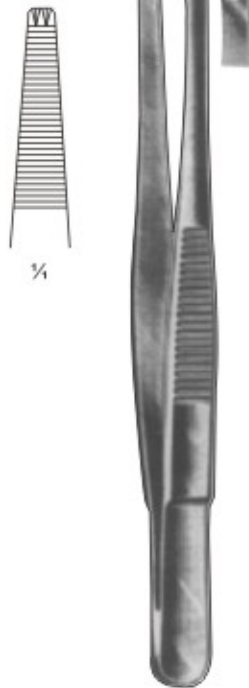

**DURANTE**  
16-183-145 14.5cm, 5 1/2"  
16-184-160 160 cm, 6 1/4"  
16-185-200 20 cm, 8"



**NELSON**  
16-186-230  
23 cm, 9"



**STILLE-BARRAYA 3:4**  
16-187-180 18 cm, 7"  
16-188-200 20 cm, 8"  
16-189-250 25 cm, 10"



**FERRIS-SMITH 1:2**  
16-190-180  
18 cm, 7"



**FERRIS-SMITH 2:3**  
16-191-180  
18 cm, 7"

# TISSUE & DRESSING FORCEPS



*Pinces a tissu, Anatomische pinzetten  
Gewebe, Pinzas de disección*

*Pinzas para tejidos, Pinces à dissection  
Pinze per tessuti, Pinze per dissezione*

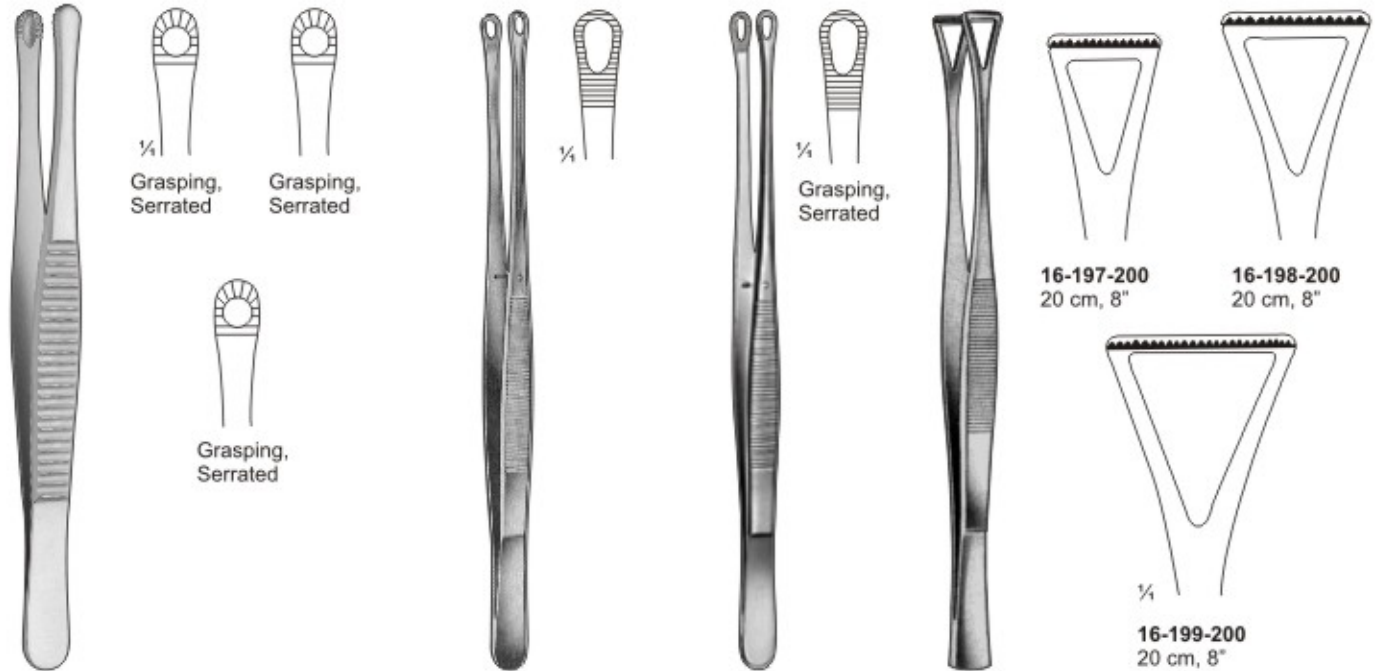

## RUSSIAN-MODELL

- 16-192-150 15 cm, 5 3/4"
- 16-193-200 20 cm, 8"
- 16-194-250 25 cm, 10"

## SINGLEY-TUTTLE

- 16-195-230  
23 cm, 9"

## SINGLEY-TUTTLE COLLIN-DUVAL INTESTINAL

- 16-196-230  
23 cm, 9"

16-197-200  
20 cm, 8"

16-198-200  
20 cm, 8"

16-199-200  
20 cm, 8"

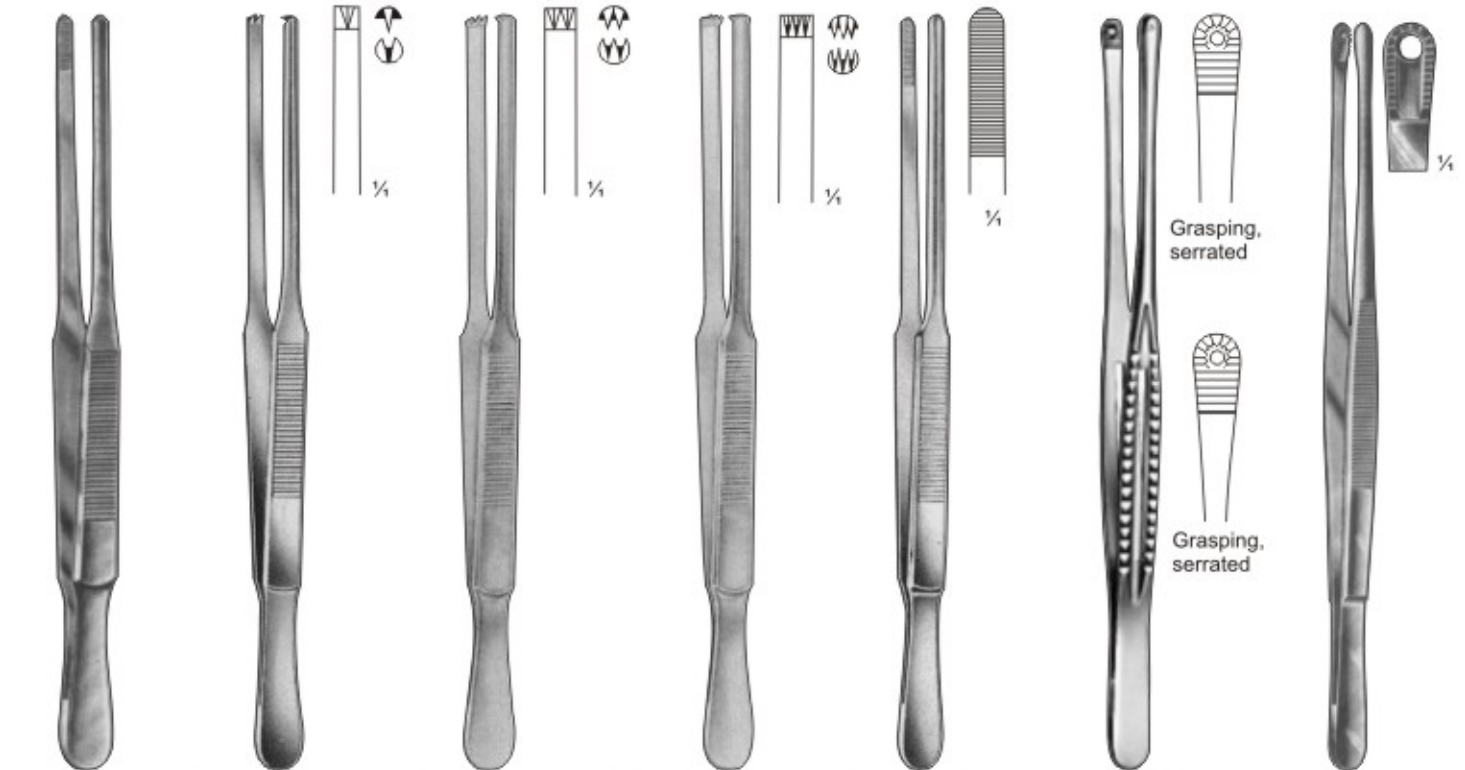

## DUEHRSSSEN

- 16-200-200  
20 cm, 8"

## DUEHRSSSEN 1:2

- 16-201-200  
20 cm, 8"

## DUEHRSSSEN 2:3

- 16-202-200  
20 cm, 8"

## DUEHRSSSEN 3:4

- 16-203-200  
20 cm, 8"

## DUEHRSSSEN

- 16-204-200  
20 cm, 8"

## MAYO-RUSSIAN

- 16-205-155  
15.5cm, 6"
- 16-206-230  
23.0cm, 9"

## DAVIS

- 16-207-250  
25 cm, 10"



## TISSUE & DRESSING FORCEPS

*Pincas a tissu, Anatomische pinzetten  
Gewebe, Pinzas de disección*

*Pinzas para tejidos, Pincas à dissection  
Pinze per tessuti, Pinze per dissezione*

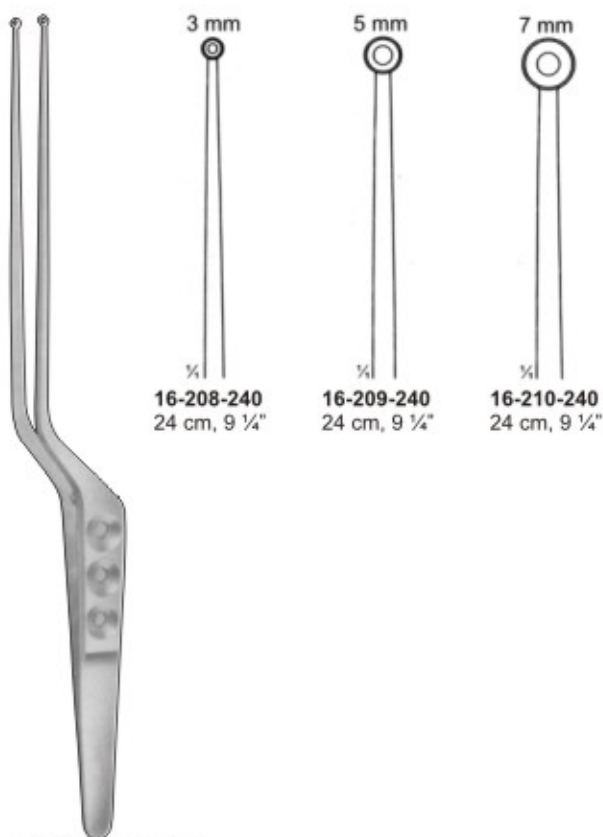

**YASARGIL-SAMI**  
Jaws Spoon-Shaped  
24 cm, 9 1/4"

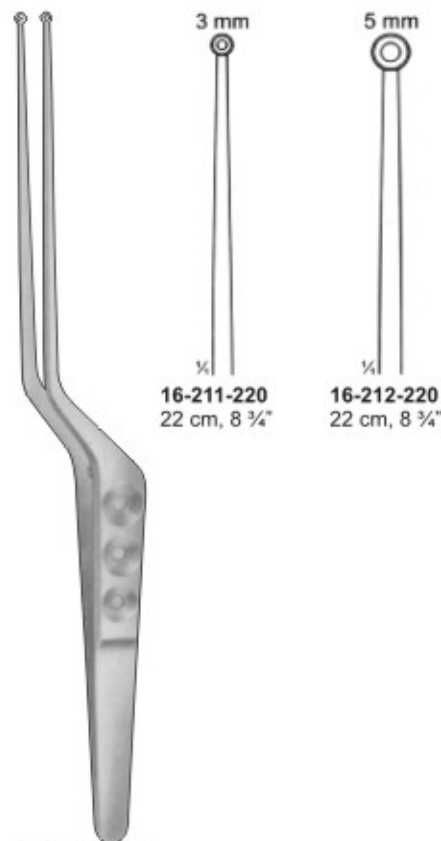

**YASARGIL**  
Jaws Spoon-Shaped  
22 cm, 8 3/4"

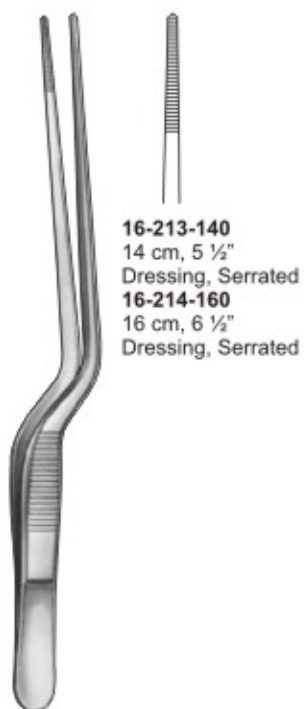

**LUCAE / ENT**

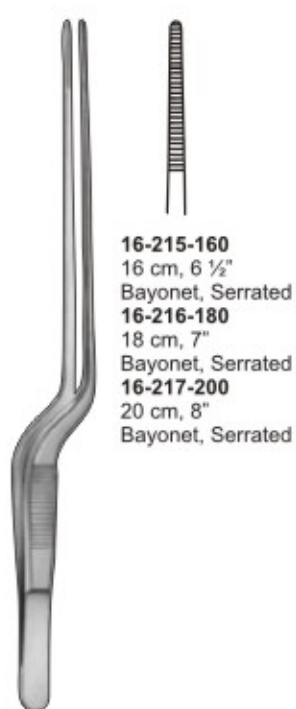

**JANSEN-GRUENWALD**

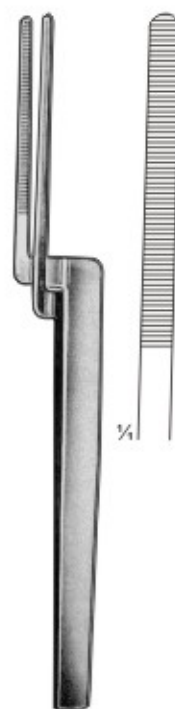

**MILLER**  
16-218-150  
15 cm, 6"

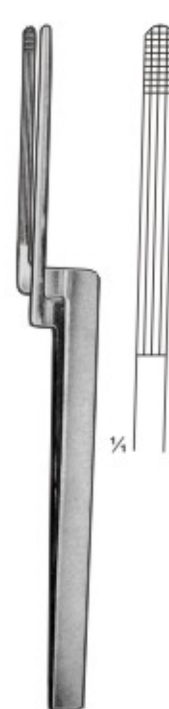

**MILLER**  
16-219-150  
15 cm, 6"

# TISSUE FORCEPS



Pinces a tissu  
Gewebe

Pinzas para tejidos  
Pinze per tessuti



**HUNT**  
16-220-200  
20 cm, 8"  
Tumor-and Vessel Forceps

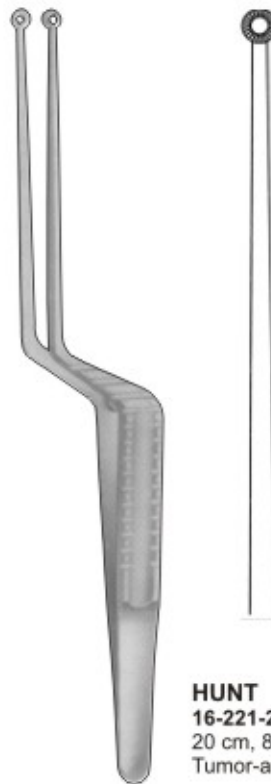

**HUNT**  
16-221-200  
20 cm, 8"  
Tumor-and Vessel Forceps

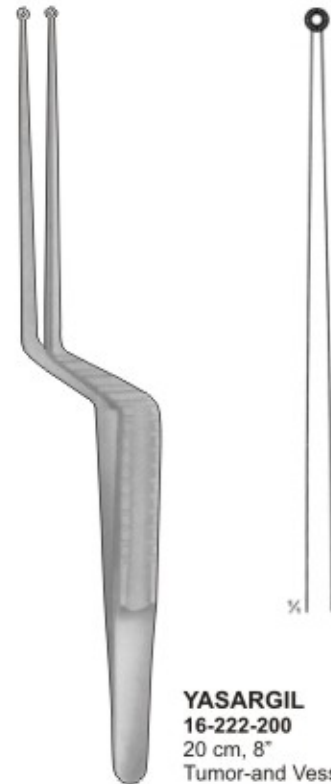

**YASARGIL**  
16-222-200  
20 cm, 8"  
Tumor-and Vessel Forceps

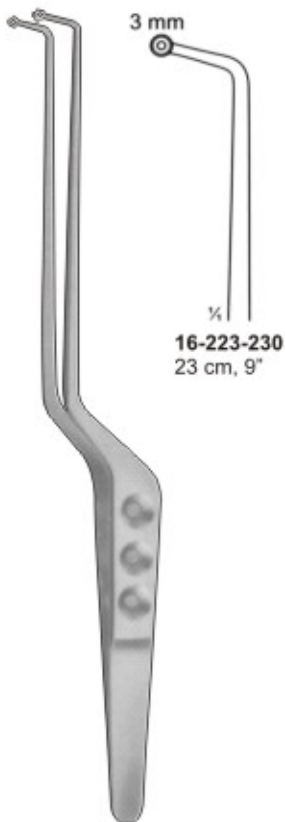

**SAMII**  
23 cm, 9"  
Jaws Spoon-Shaped



16-224-230  
23 cm, 9"



16-225-230  
23 cm, 9"



16-226-230  
23 cm, 9"

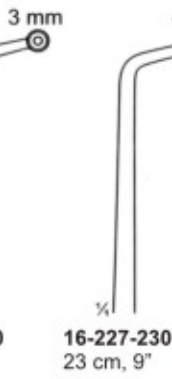

16-227-230  
23 cm, 9"



16-228-230  
23 cm, 9"

**SAMII**  
23 cm, 9"  
Jaws Spoon-Shaped



# TISSUE & DRESSING FORCEPS

*Pinces a tissu, Anatomische pinzetten  
Gewebe, Pinzas de disección*

*Pinzas para tejidos, Pinces à dissection  
Pinze per tessuti, Pinze per dissezione*



**16-229-120**  
12 cm, 5"  
Tissue, 7:7 Teeth

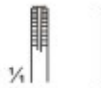

**16-230-120**  
12 cm, 5"  
Tissue, 9:9 Teeth

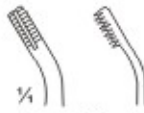

9:9

**ADSON-BROWN**  
16-231-120 12 cm, 5"

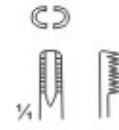

**16-232-150**  
15 cm, 6"  
Straight, 9:9 Teeth

**BROWN**



**16-233-120**  
12 cm, 5"  
dressing, serrated



**16-234-120**  
12 cm, 5"  
dressing,  
Micro serrated



**16-235-120**  
12 cm, 5"  
dressing, serrated  
tungsten carbide



**16-236-120**  
12 cm, 5"  
Tissue,  
1:2 Teeth



**16-237-120**  
12 cm, 5"  
Tissue, Micro 1:2 Teeth  
**16-238-120**  
12 cm, 5"  
Tissue, 2:3 Teeth



**16-239-120**  
12 cm, 5"  
Dressing, Serrated



**16-240-120**  
12 cm, 5"  
Tissue, 1:2 Teeth

**EWALD / HUDSON**

# TISSUE & DRESSING FORCEPS



*Pinces a tissu, Anatomische pinzetten  
Gewebe, Pinzas de disección*

*Pinzas para tejidos, Pinces à dissection  
Pinze per tessuti, Pinze per dissezione*



**16-241-120**  
12 cm, 5"  
Dressing,  
Micro serrated

**16-242-120**  
12 cm, 5"  
Tissue,  
Micro-1:2 Teeth

**16-243-120**  
12 cm, 5"  
Tissue, 1:2 Teeth



**DE BAKKEY /  
LIGHTWEIGHT**  
**16-244-160**  
16 cm, 6 1/2"



**DE BAKKEY**

1.5mm  
**16-245-160**  
16 cm, 6 1/2"

2.0mm  
**16-246-160**  
16 cm, 6 1/2"

2.0mm  
**16-247-160**  
16 cm, 6 1/2"

**LIGHTWEIGHT-  
ADSON**



**16-248-145**  
14.5 cm, 6"

**MODELL USA**



**16-249-145**  
14.5 cm, 6"  
1:2 teeth

**MODELL USA**



**MCINDOE**  
**16-250-150**  
15 cm, 6"

**GILLIES**  
**16-251-150**  
15 cm, 6"  
1:2 teeth





# ATRAUMATIC DRESSING FORCEPS

Atraumatische Pinzette  
Pinza de disección atraumática

Pince atraumatique à dissection  
Pinza atraumatica



2.7 mm

## DEBAKEY

- 16-252-150 15cm 6"
- 16-253-200 20cm 8"
- 16-254-240 24cm 9 1/2"
- 16-255-300 30cm 12"



3.5 mm

## DEBAKEY

- 16-256-150 15cm 6"
- 16-257-200 20cm 8"
- 16-258-240 24cm 9 1/2"
- 16-259-300 30cm 12"



2 mm

## COOLEY

- 16-260-150 15cm 6"
- 16-261-200 20cm 8"
- 16-262-240 24cm 9 1/2"
- 16-263-300 30cm 12"



1.2 mm

- 16-264-180 18 cm, 7"
- 16-265-210 21 cm, 8 1/4"

2 mm

- 16-266-180 18 cm, 7"
- 16-267-210 21 cm, 8 1/4"



## DEBAKEY

- 16-275-160 16 cm, 6 1/2" 2.7mm
- 16-276-200 20 cm, 8" 2.7mm
- 16-277-200 20 cm, 8" 2.7mm Heavy
- 16-278-240 24 cm, 9 1/2" 2.7mm
- 16-279-305 30.5 cm, 12" 2.7mm



- 16-271-160 16 cm, 6 1/2" 2.0mm
- 16-272-200 20 cm, 8" 2.0mm
- 16-273-240 24 cm, 9 1/2" 2.0mm
- 16-274-305 30.5 cm, 12" 2.0mm



- 16-280-160 16 cm, 6 1/2" 3.5mm
- 16-281-200 20 cm, 8" 3.5mm
- 16-282-240 24 cm, 9 1/2" 3.5mm
- 16-283-305 30.5 cm, 12" 3.5mm



## DE BAKEY



2.0mm

- 16-284-160 16 cm, 6 1/2"

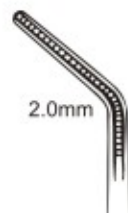

2.0mm

- 16-285-200 20 cm, 8"



2.0mm

- 16-286-240 24 cm, 9 1/2"

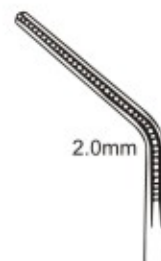

2.0mm

- 16-287-300 30 cm, 12"

# MICRO FORCEPS



Mikropinzetten  
Micro-Pinzas

Micro-Pinces  
Micro-Pinze



**MICRO FORCEPS**  
16-288-140 1:2  
14.0 cm, 5 1/2"



**MICRO FORCEPS**  
16-289-140 1:2  
14.0 cm, 5 1/2"



**MICRO FORCEPS**  
16-290-140 14.0 cm, 5 1/2"  
16-291-180 18.0 cm, 7"

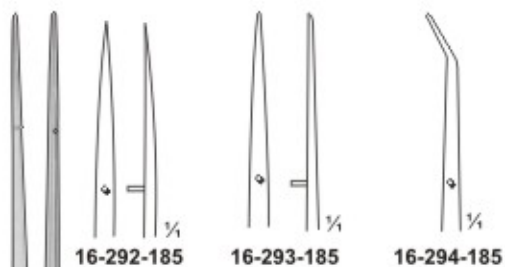

16-292-185

16-293-185

16-294-185



**MICRO FORCEPS**  
18.5cm, 7 1/4"

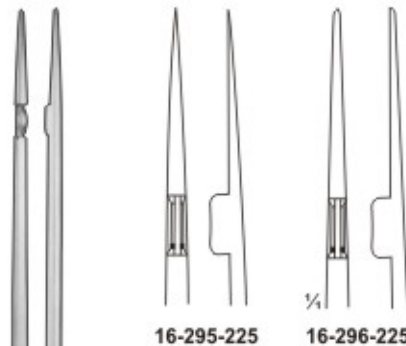

16-295-225

16-296-225



**MICRO FORCEPS**  
22.5cm, 9"



**MICRO FORCEPS**  
16-297-140 14.0 cm, 5 1/2"



# MICRO FORCEPS

Mikropinzetten  
Micro-Pinzas

Micro-Pinces  
Micro-Pinze



**STEVENS**  
10.5cm, 4"



**16-298-105**  
Straight



**16-299-105**  
Curved



**16-300-105**  
Curved



**16-301-105**  
Straight



**16-302-105**  
Curved



**16-303-105**  
Curved



**MICRO FORCEPS**



0.3 mm  
**16-304-120**  
12.0cm, 5"  
Straight



0.3 mm  
**16-305-150**  
15.0cm, 6"  
Curved



**MICRO FORCEPS**  
18.0 cm, 7"



**16-306-180**  
Straight



**16-307-180**  
Curved

# TISSUE & DRESSING FORCEPS



*Pinces a tissu, Anatomische pinzetten  
Gewebe, Pinzas de disección*

*Pinzas para tejidos, Pinces à dissection  
Pinze per tessuti, Pinze per dissezione*



**GRAEFE**



**16-308-070**  
7.0 cm, 2 ¾"  
**16-309-100**  
10.0 cm, 4"



**16-310-070**  
7.0 cm, 2 ¾"  
**16-311-100**  
10.0 cm, 4"



**16-312-070**  
7.0 cm, 2 ¾"  
**16-313-100**  
10.0 cm, 4"



**16-314-070**  
7.0 cm, 2 ¾"  
**16-315-100**  
10.0 cm, 4"



**16-316-070**  
7.0 cm, 2 ¾"  
**16-317-100**  
10.0 cm, 4"



**16-318-070**  
7.0 cm, 2 ¾"  
**16-319-100**  
10.0 cm, 4"



**STEVENS 1:2**



**16-320-110**  
11.0 cm, 4 ½"



**STEVENS 1:2**



**16-321-110**  
11.0 cm, 4 ½"



**GRAEFE**  
**16-322-070** 0.5 mm  
**16-323-070** 0.7 mm  
**16-324-070** 1.0 mm  
7.0 cm, 3"



**GRAEFE**  
**16-325-070** 0.5 mm  
**16-326-070** 0.7 mm  
**16-327-070** 1.0 mm  
7.0 cm, 3"



**GRAEFE 1:2**  
**16-328-070** 0.5 mm  
**16-329-070** 0.7 mm  
**16-330-070** 1.0 mm  
7.0 cm, 3"



**GRAEFE 1:2**  
**16-331-070** 0.5 mm  
**16-332-070** 0.7 mm  
**16-333-070** 1.0 mm  
7.0 cm, 3"





## JEWELER TYPE, DISSECTING FORCEPS

Chirurgische pinzetten, Uhrmacher-Pinzetten  
Pinzas de disección con dientes, Pinzas de relojero

Pinces à dissection à groffes, Pinces d'horloger  
Pinze per dissezione con denti, Pinze de orologiaio



**JEWELER'S FORCEPS**  
16-334-115 11.5 cm, 4 1/2"



1/4  
16-335-105  
10.5 cm, 4"



16-336-105  
10.5 cm, 4"



16-337-110  
11 cm, 4 1/2"



16-338-110  
11 cm, 4 1/2"



1/4  
16-339-110  
11 cm, 4 1/2"



16-340-120  
12 cm, 5"



16-341-120  
12 cm, 5"



16-342-120  
12 cm, 5"



Jewelers Forceps  
16-343-001



Jewelers Forceps  
16-344-002



Jewelers Forceps  
16-345-003



Jewelers Forceps  
16-346-004



Jewelers Forceps  
16-347-005



Jewelers Forceps  
16-348-006



Jewelers Forceps  
16-349-007



Jewelers Forceps  
16-350-008

# CILIA FORCEPS



Cilienpinzetten  
Pinzas depilatorias

Pinces à épiler les cils  
Pinze depilatoria



**ZIEGLER**  
16-351-090  
9 cm, 3 1/2"



**DOUGLAS**  
16-352-090  
9 cm, 3 1/2"

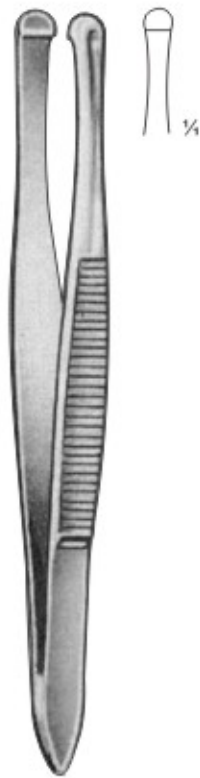

**BEER**  
16-353-090  
9 cm, 3 1/2"



**GRADLE**  
16-354-105  
10.5cm, 4"

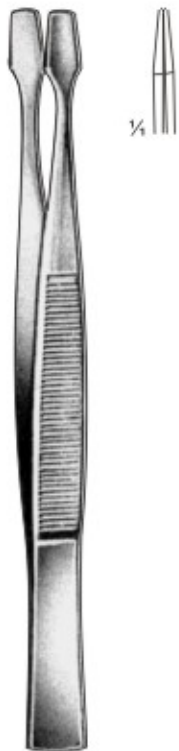

**KUEHNE**  
16-355-105  
10.5cm, 4"



**KUEHNE**  
16-356-105  
10.5cm, 4"



**BARRAQUER**  
16-357-105  
10.5cm, 4"



**LITTAUER**  
16-358-085  
8.5 cm, 3"



**LITTAUER**  
16-359-090  
9 cm, 3 1/2"



# SPLINTER FORCEPS

*Splitterpinzetten*  
*Pinzas Para espinas*

*Pinces à échardes*  
*Pinze per scheggie*



16-360-080 8 cm, 3"  
16-361-090 9 cm, 3 1/2"  
16-362-105 10.5 cm, 4"  
16-363-115 11.5 cm, 4 1/2"  
16-364-125 12.5 cm, 5"  
16-365-145 14.5 cm, 5 1/2"  
Straight



16-366-080 8 cm, 3"  
16-367-090 9 cm, 3 1/2"  
16-368-105 10.5 cm, 4"  
16-369-115 11.5 cm, 4 1/2"  
16-370-125 12.5 cm, 5"  
16-371-145 14.5 cm, 5 1/2"  
Curved



16-372-080 8 cm, 3"  
16-373-090 9 cm, 3 1/2"  
16-374-105 10.5 cm, 4"  
16-375-115 11.5 cm, 4 1/2"  
16-376-125 12.5 cm, 5"  
16-377-145 14.5 cm, 5 1/2"  
Straight

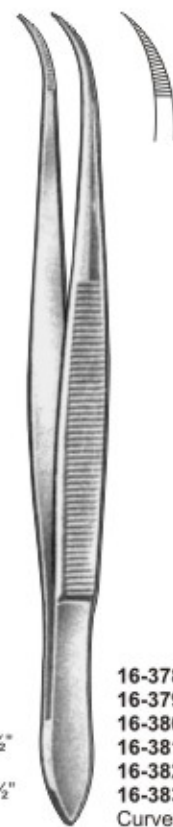

16-378-080 8 cm, 3"  
16-379-090 9 cm, 3 1/2"  
16-380-105 10.5 cm, 4"  
16-381-115 11.5 cm, 4 1/2"  
16-382-125 12.5 cm, 5"  
16-383-145 14.5 cm, 5 1/2"  
Curved



16-384-075 7.5 cm, 3"  
16-385-090 9 cm, 3 1/2"  
16-386-110 11 cm, 4"  
Straight



16-387-105 10.5 cm, 4"  
Straight



16-388-105 10.5 cm, 4"  
Curved



16-389-105 10.5 cm, 4"  
Straight



16-390-105 10.5 cm, 4"  
Curved



FEILCHENFELD

HUNTER

HUNTER

CARMALT

CARMALT

# SPLINTER FORCEPS



Splitterpinzetten  
Pinzas Para espinas

Pinces à échardes  
Pinze per scheggie



16-391-080 8.0 cm, 3"  
16-392-090 9.0 cm, 3 1/2"  
16-393-105 10.5 cm, 4"  
16-394-115 11.5 cm, 4 1/2"  
16-395-125 12.5 cm 5"  
16-396-145 14.5 cm 6"  
Straight

16-397-080 8.0 cm, 3"  
16-398-090 9.0 cm, 3 1/2"  
16-399-105 10.5 cm, 4"  
16-400-115 11.5 cm, 4 1/2"  
16-401-125 12.5 cm 5"  
16-402-145 14.5 cm 6"  
Curved

16-403-080 8.0 cm, 3"  
16-404-090 9.0 cm, 3 1/2"  
16-405-105 10.5 cm, 4"  
16-406-115 11.5 cm, 4 1/2"  
16-407-125 12.5 cm 5"  
16-408-145 14.5 cm 6"  
Straight

16-409-080 8.0 cm, 3"  
16-410-090 9.0 cm, 3 1/2"  
16-411-105 10.5 cm, 4"  
16-412-115 11.5 cm, 4 1/2"  
16-413-125 12.5 cm 5"  
16-414-145 14.5 cm 6"  
Curved

**STIEGLITZ  
FORCEPS**  
16-415-125  
12.5 cm, 5"

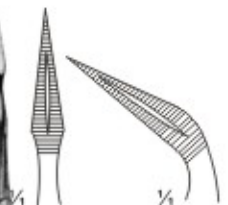
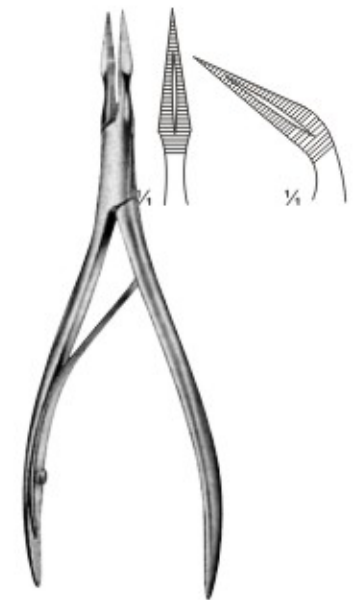
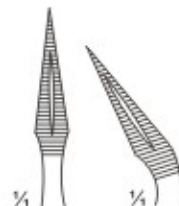
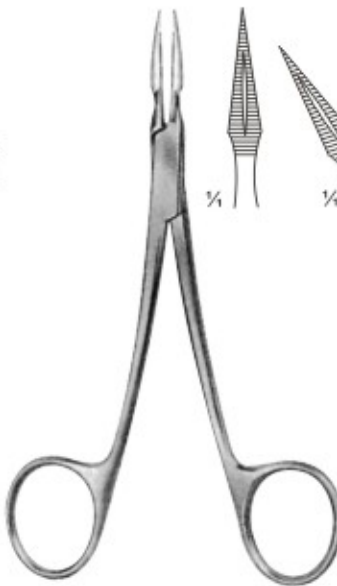
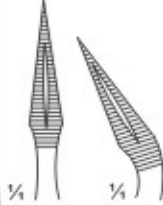
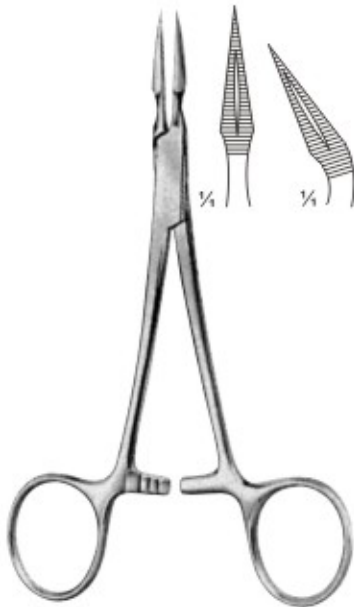

**STIEGLITZ**  
16-416-140 14 cm, 5 1/2" Str.  
16-417-140 14 cm, 5 1/2" Cvd.

**STIEGLITZ**  
16-418-140 14 cm, 5 1/2" Str.  
16-419-140 14 cm, 5 1/2" Cvd.

**PEET**  
16-420-115  
11.5 cm, 4 1/2"

**RALK**  
16-421-150 15 cm, 6" Str.  
16-422-150 15 cm, 6" Cvd.





## TISSUE & DRESSING FORCEPS T.C. INSERTED

*Pinces a tissu, Anatomische pinzetten  
Gewebe, Pinzas de disección*

*Pinzas para tejidos, Pinces à dissection  
Pinze per tessuti, Pinze per dissezione*



**16-423-130**  
13 cm, 5 1/4"

**16-424-140**  
14 cm, 5 1/2"

**16-425-160**  
16 cm, 6 1/4"

**16-426-180**  
18 cm, 7"

**16-427-200**  
20 cm, 8"

**16-428-250**  
25 cm, 10"

**STANDARD**



**16-429-140**  
14 cm, 5 1/2"

**16-430-160**  
16 cm, 6 1/4"

**16-431-180**  
18 cm, 7"

**16-432-200**  
20 cm, 8"

**16-433-250**  
25 cm, 10"

**16-434-300**  
30 cm, 12"

**STANDARD**



**STANDARD**  
**16-435-140** 14 cm, 5 1/2"  
**16-436-160** 16 cm, 6 1/4"



**ADSON**

**16-437-120**  
12 cm, 5"  
cross serration

**16-438-120**  
12 cm, 5"  
cross serration-  
1:2 Teeth

**16-439-150**  
15.0 cm, 6"  
cross serration-  
1:2 Teeth

**16-440-120**  
12 cm, 5"  
Dressing,  
cross serration

**16-441-120**  
12 cm, 5"  
Tissue, cross  
serration-1:2 Teeth

# TISSUE & DRESSING FORCEPS T.C. INSERTED



*Pinces a tissu, Anatomische pinzetten  
Gewebe, Pinzas de disección*

*Pinzas para tejidos, Pinces à dissection  
Pinze per tessuti, Pinze per dissezione*



**CUSHING TISSUE  
FORCEPS**  
16-442-178  
17.8 cm, 7"



**CUSHING**  
16-443-180  
18 cm, 7"  
Cross Serrated



**CUSHING**  
16-444-180  
18 cm, 7"



**DISSECTING  
TISSUE FORCEPS**  
16-445-180  
18 cm, 7"



**ADSON**  
16-446-120  
12 cm, 5"



**ADSON**  
16-447-210  
21 cm, 8 1/2"

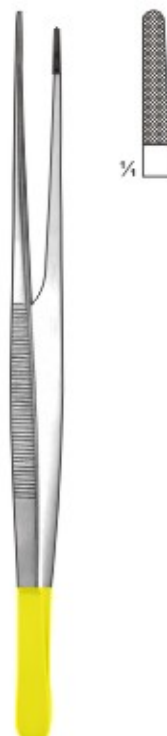

**RESANO**  
16-448-250  
25 cm, 10"



**CUSHING TISSUE  
FORCEPS**  
16-449-190  
19 cm, 7 1/2"



## TISSUE & DRESSING FORCEPS T.C. INSERTED

Pincas a tissu, Anatomische pinzetten  
Gewebe, Pinzas de disección

Pinzas para tejidos, Pincas à dissection  
Pinze per tessuti, Pinze per dissezione

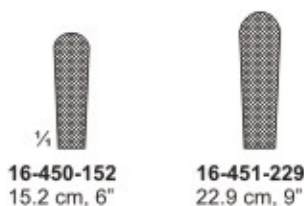

**WANGENSTEEN**  
16-453-150 15 cm, 6"  
16-454-230 23 cm, 9"  
16-455-250 25 cm, 10"



**DEBAKEY MICRO NEEDLE  
PULLING TISSUE FORCEPS**  
16-456-184  
18.4 cm, 7"

**WANGENSTEEN TISSUE  
FORCEPS**

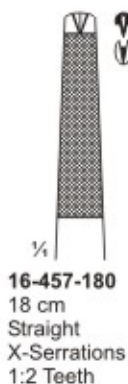

**BONNEY  
DISSECTING**



**POTTS-SMITH  
FORCEPS**  
16-460-150 15 cm, 6"  
16-461-180 18 cm, 7"  
16-462-200 20 cm, 8"  
16-463-230 23 cm, 9"  
16-464-250 25 cm, 10"



**POTTS-SMITH**  
16-465-160 16 cm, 6 1/2"  
16-466-180 18 cm, 7"  
16-467-210 21 cm, 8 1/2"  
16-468-240 24 cm, 9 1/2"  
16-469-260 26 cm, 10 1/2"



**POTTS-AMITH**  
16-470-200  
20 cm, 8"

# DRESSING FORCEPS T.C. INSERTED

Anatomische pinzetten  
Pinzas de disección

Pinces à dissection  
Pinze per dissezione



16-471-130 13 cm, 5"  
16-472-140 14 cm, 5 1/2"  
16-473-150 15 cm, 6"

16-474-180 18 cm, 7"  
16-475-200 20 cm, 8"  
16-476-250 25 cm, 10"

**TISSUE FORCEPS**



**CUSHING TISSUE FORCEPS**  
16-477-178  
17.8 cm, 7"



**CUSHING**  
16-478-180  
18 cm, 7"



**EVANS PELVIC NEEDLE TISSUE**  
16-479-254  
25.4 cm, 10"



**EVANS**  
16-480-250  
25 cm, 10"

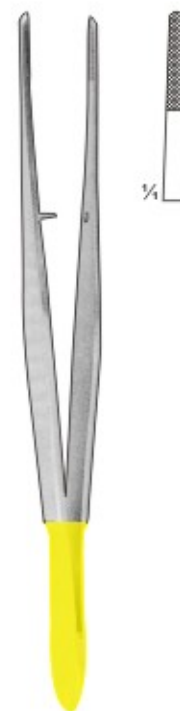

**TISSUE FORCEPS**  
16-481-146  
14.6 cm, 6"



# **HAEMOSTATIC FORCEPS**

---

- **HAEMOSTATIC FORCEPS**
- **TOWEL CLAMPS**
- **TUBING FORCEPS**
- **SPONGE FORCEPS**

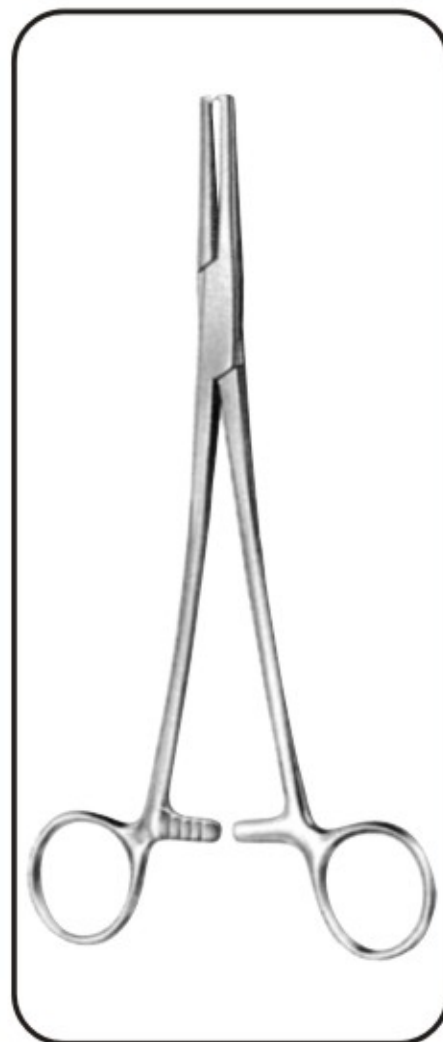
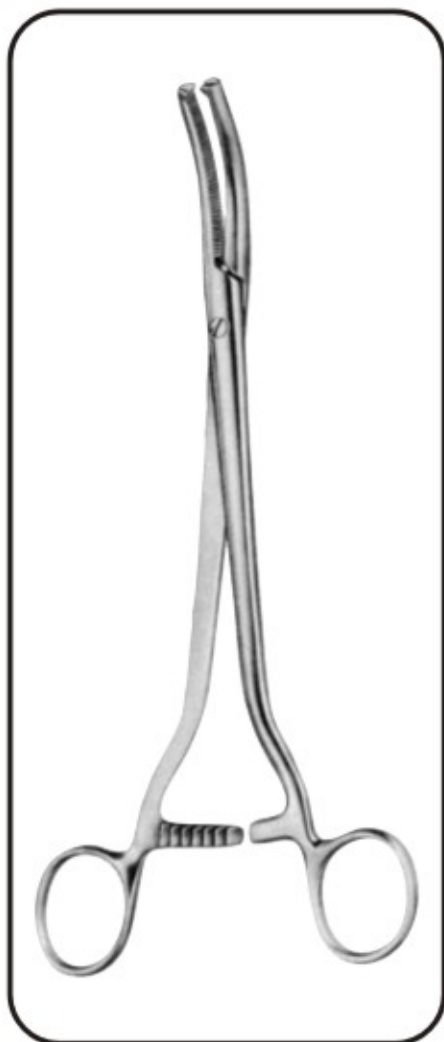

# HAEMOSTATIC FORCEPS



Arterienklemmen  
Pinzas hemostaticas

Pinces hemostatiques  
Pinze emostatiche

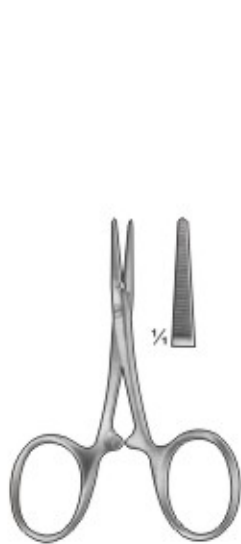

**CARREL**  
17-001-085  
8.5 cm, 3 1/4"

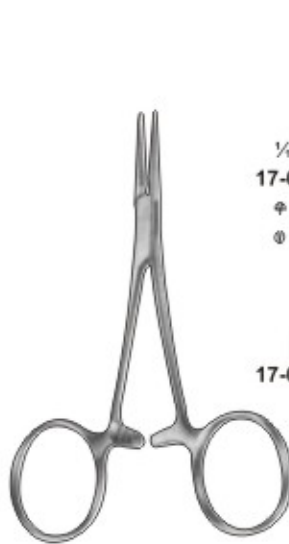

**BABY-MOSQUITO  
(HARTMANN)**  
17-002-100  
10.0 cm, 4"

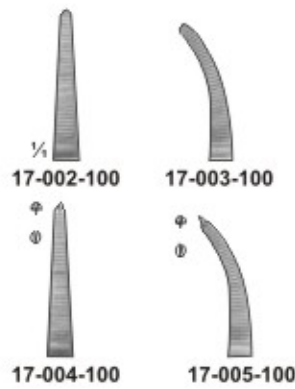

**MICRO-HALSTED**  
17-006-125  
12.5 cm, 5"

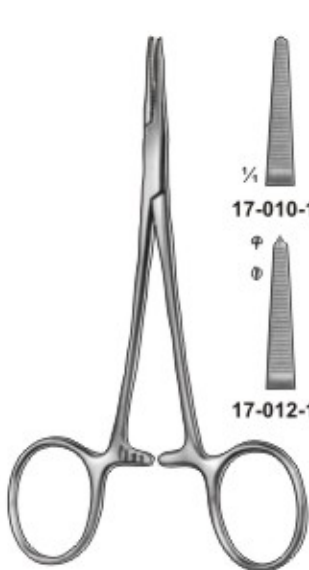
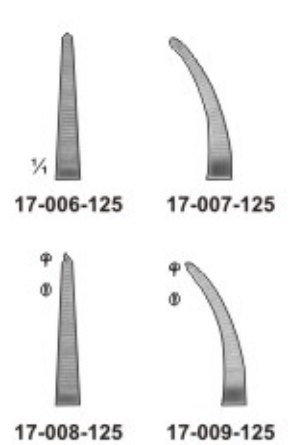

**HALSTED-MOSQUITO**  
17-010-125  
12.5 cm, 5"

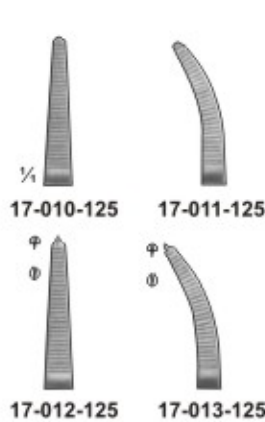

**PROVIDENCE-HOSPITAL**  
17-014-140  
14.0 cm, 5 1/2"

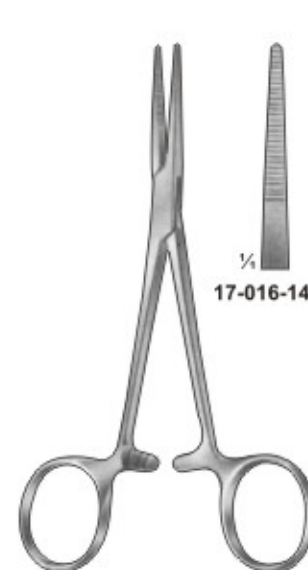

**KELLY**  
17-016-140  
14.0 cm, 5 1/2"





# HAEMOSTATIC FORCEPS

Arterienklemmen  
Pinzas hemostaticas

Pinces hemostatiques  
Pinze emostatiche

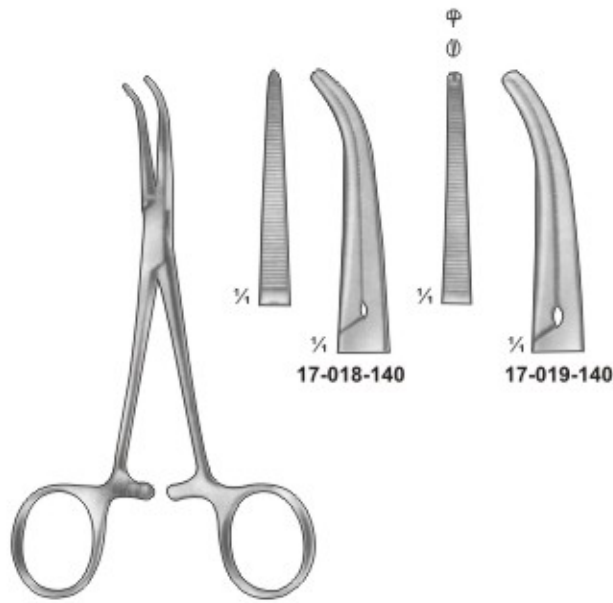

**DANDY**  
14.0 cm, 5 1/2"  
Curved sideways

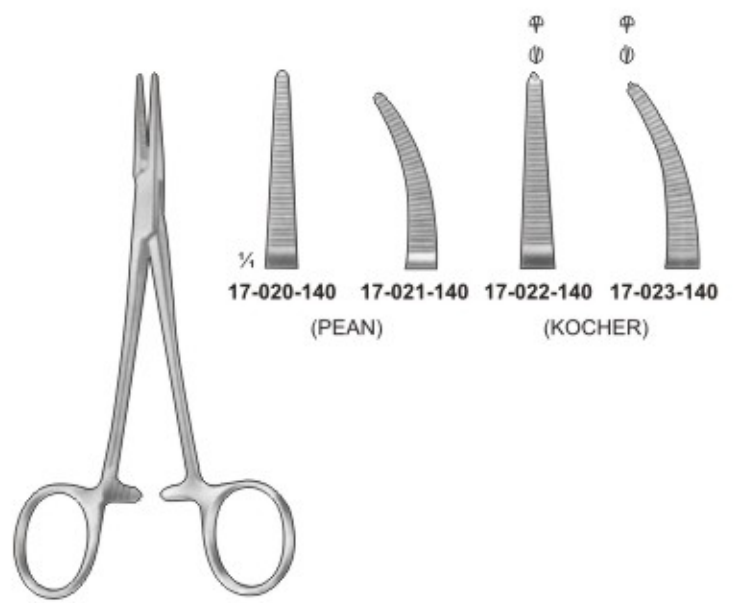

**BABY-CRILE**  
14.0 cm, 5 1/2"

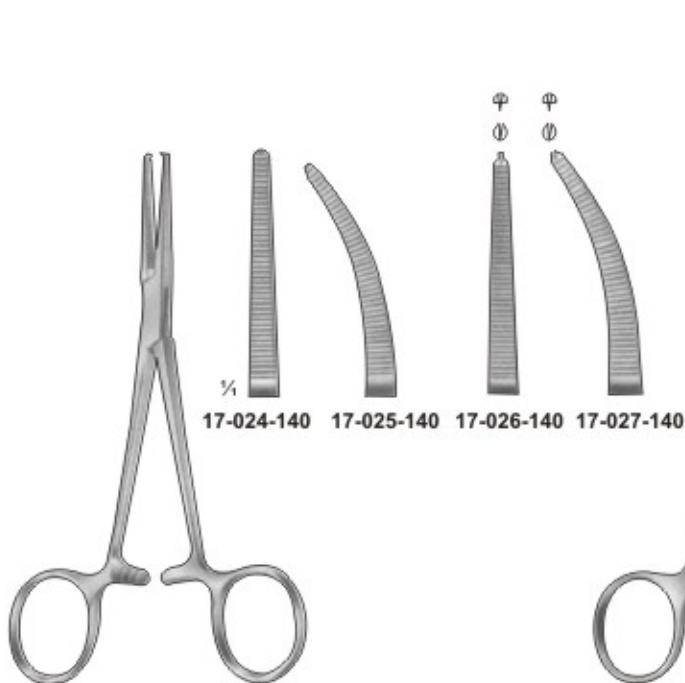

**CRILE**  
14.0 cm, 5 1/2"

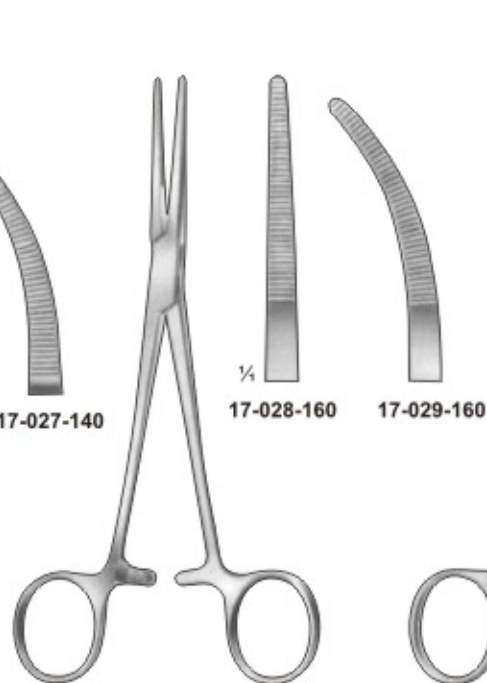

**RANKIN**  
16.0 cm, 6 1/4"

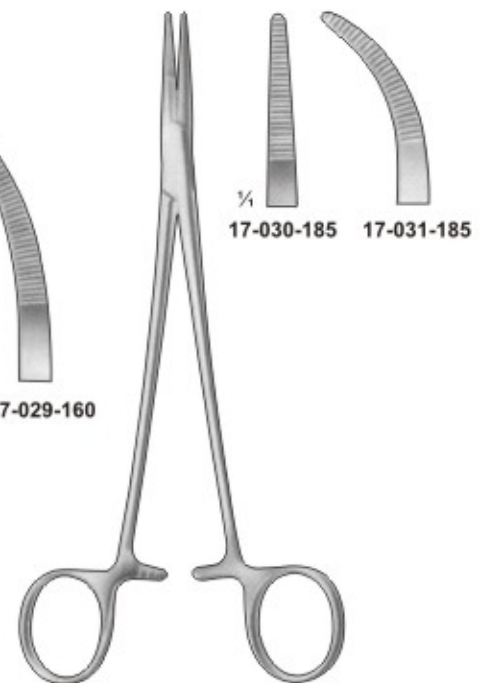

**ADSON**  
18.5 cm, 7 1/4"

# HAEMOSTATIC FORCEPS



Arterienklemmen  
Pinzas hemostaticas

Pinces hemostatiques  
Pinze emostatiche

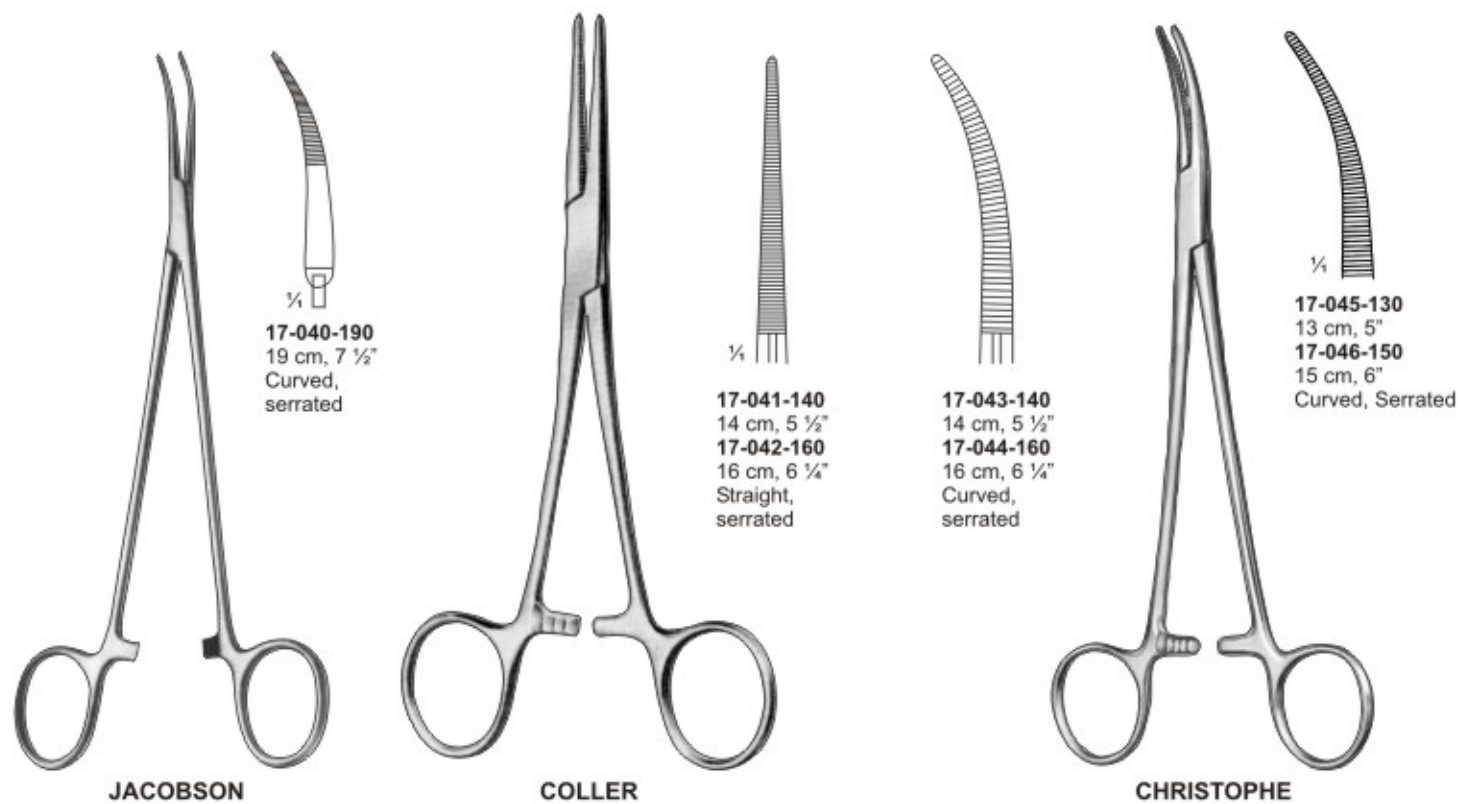
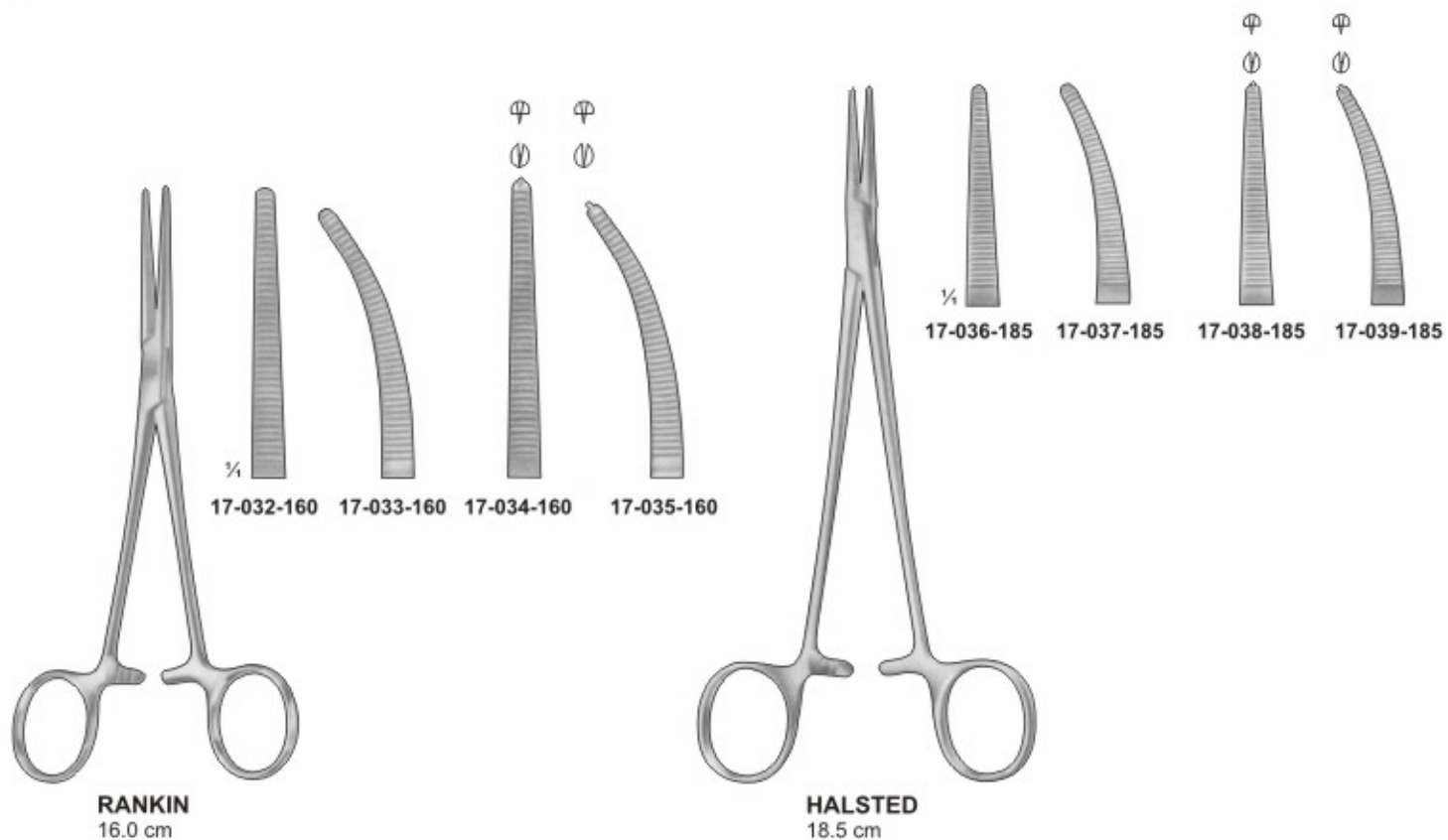





# HAEMOSTATIC FORCEPS

Arterienklemmen  
Pinzas hemostaticas

Pinces hemostatiques  
Pinze emostatiche

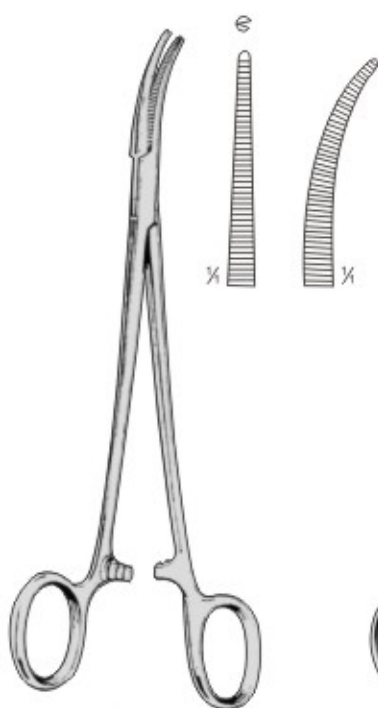

**ADSON**  
17-047-180 18.0 cm, 7"  
Straight, box joint,  
as above but curved flat.  
Straight, box joint,  
one into two teeth



**ADSON 1:2**

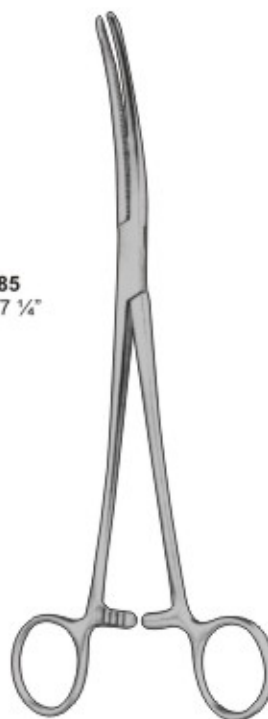
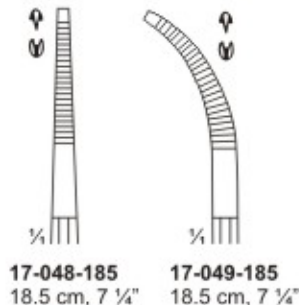

**SAROOT**

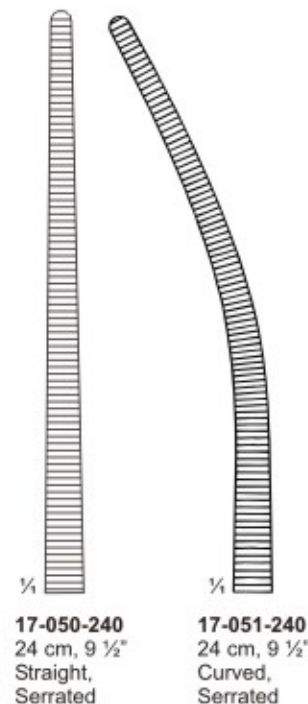

**17-051-240**  
24 cm, 9 1/2"  
Curved,  
Serrated

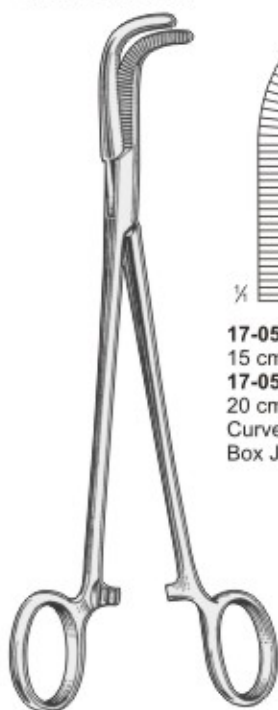

**O'SHAUGHNESSY**

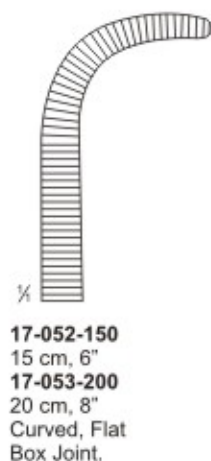

**17-052-150**  
15 cm, 6"  
**17-053-200**  
20 cm, 8"  
Curved, Flat  
Box Joint.

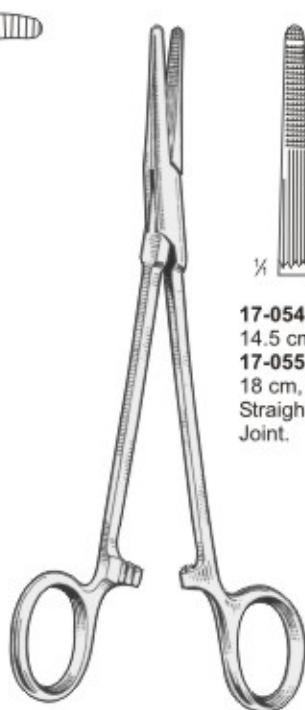

**GREY TURNER**

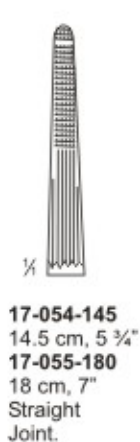

**17-054-145**  
14.5 cm, 5 3/4"  
**17-055-180**  
18 cm, 7"  
Straight  
Joint.

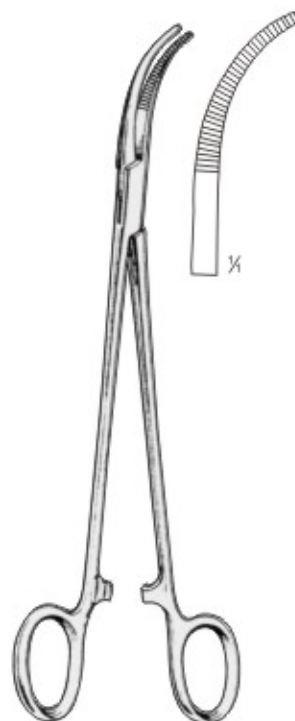

**SAWTELL**  
17-056-185 18.5 cm, 7 1/4"  
curved on flat joint



**DUNHILL**  
17-057-130  
13.0 cm, 5"  
Straight, box joint, as  
above but curved on flat.

# HAEMOSTATIC FORCEPS

Arterienklemmen  
Pinzas hemostaticas

Pinces hemostatiques  
Pinze emostatiche

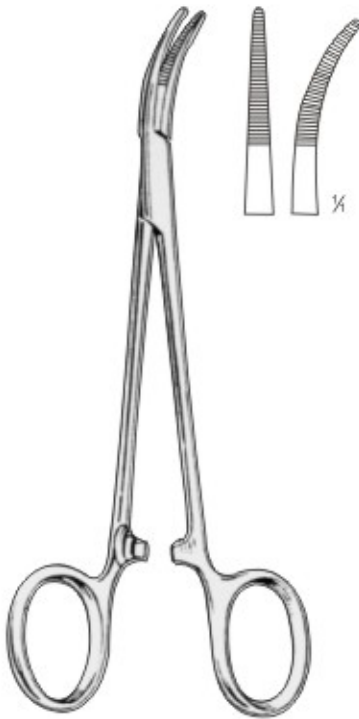

**CAIRNS**  
17-058-145  
14.5 cm, 5 3/4"  
Straight, box joint, as  
above but curved on flat.

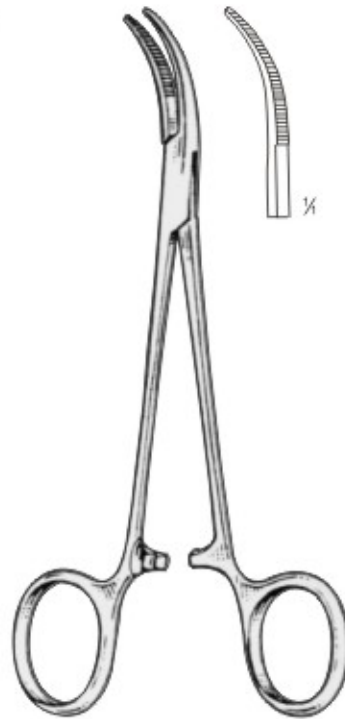

**CAIRNS**  
17-059-145  
14.5 cm, 5 3/4"  
curved laterally,  
joint



1/4  
**17-060-270**  
27 cm, 10 3/4"  
Right Angle,  
Serrated

**MEEKER**

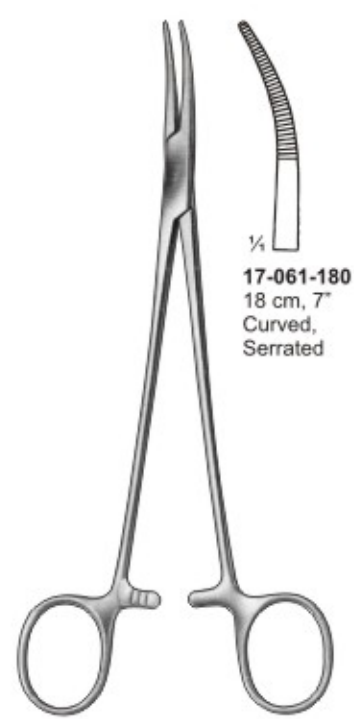

1/4  
**17-061-180**  
18 cm, 7"  
Curved,  
Serrated

**SCHNIDT / SAWTELL**

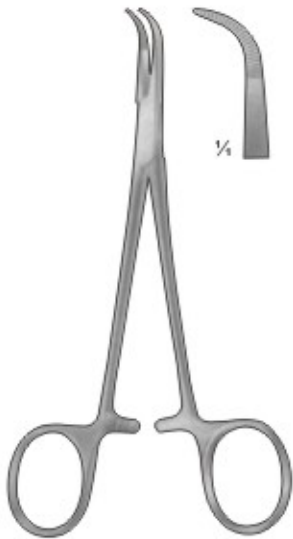

**MICRO-ADSON**  
17-062-140  
14.0 cm

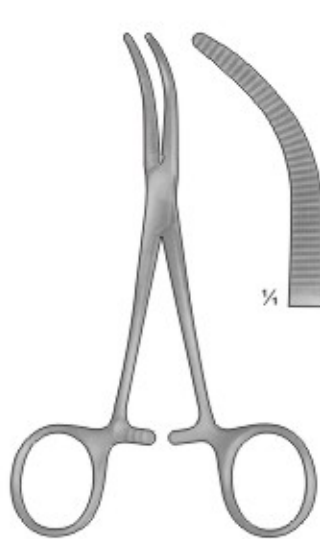

**BABY-OVERHOLT**  
17-063-135  
13.5 cm

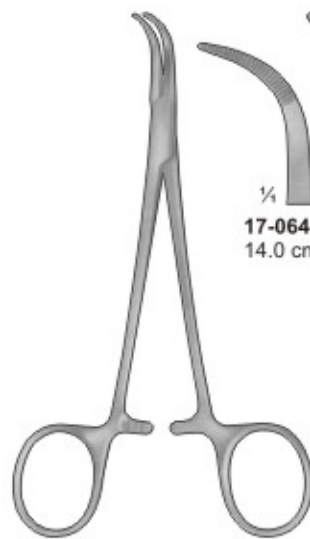

1/4  
**17-064-140** 14.0 cm  
**17-065-180** 18.0 cm

**BABY-MIXTER**

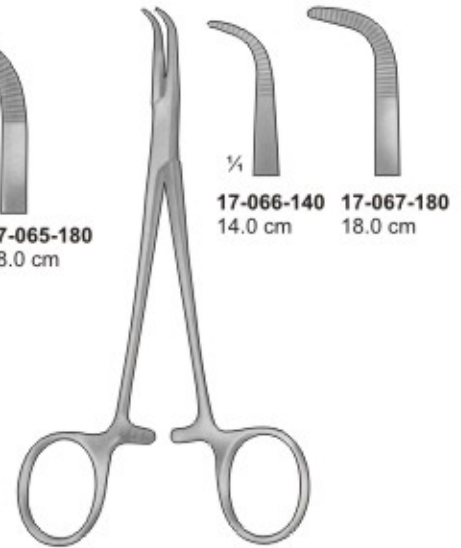

1/4  
**17-066-140** 14.0 cm  
**17-067-180** 18.0 cm

**BABY-ADSON**



# HAEMOSTATIC FORCEPS

Arterienklemmen  
Pinzas hemostaticas

Pinces hemostatiques  
Pinze emostatiche

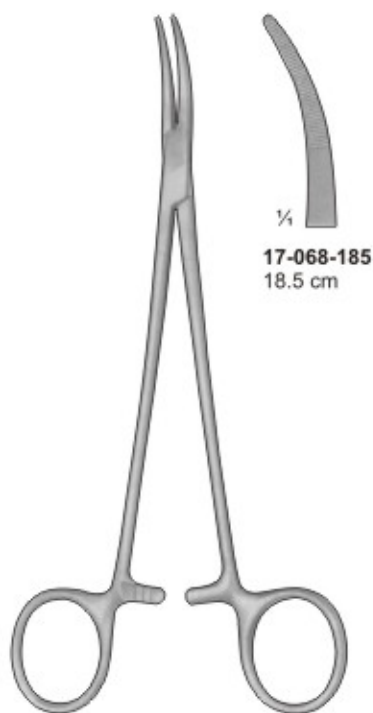

$\frac{1}{4}$   
**17-068-185**  
18.5 cm

**NISSEN**



$\frac{1}{4}$   
**17-069-195** **17-070-195**  
19.5 cm 19.5 cm

**YASARGIL**

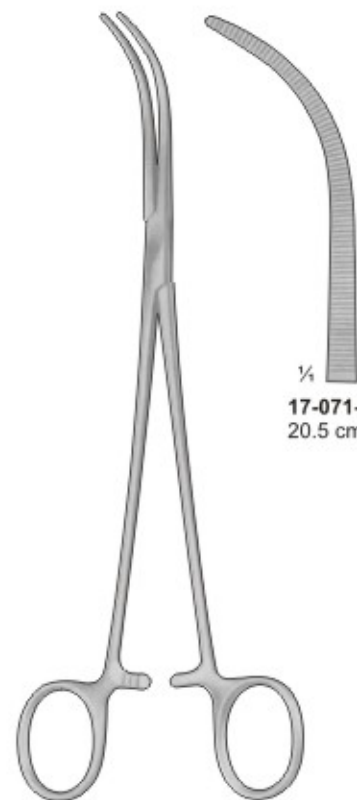

$\frac{1}{4}$   
**17-071-205**  
20.5 cm

**OVERHOLT-MIXTER**

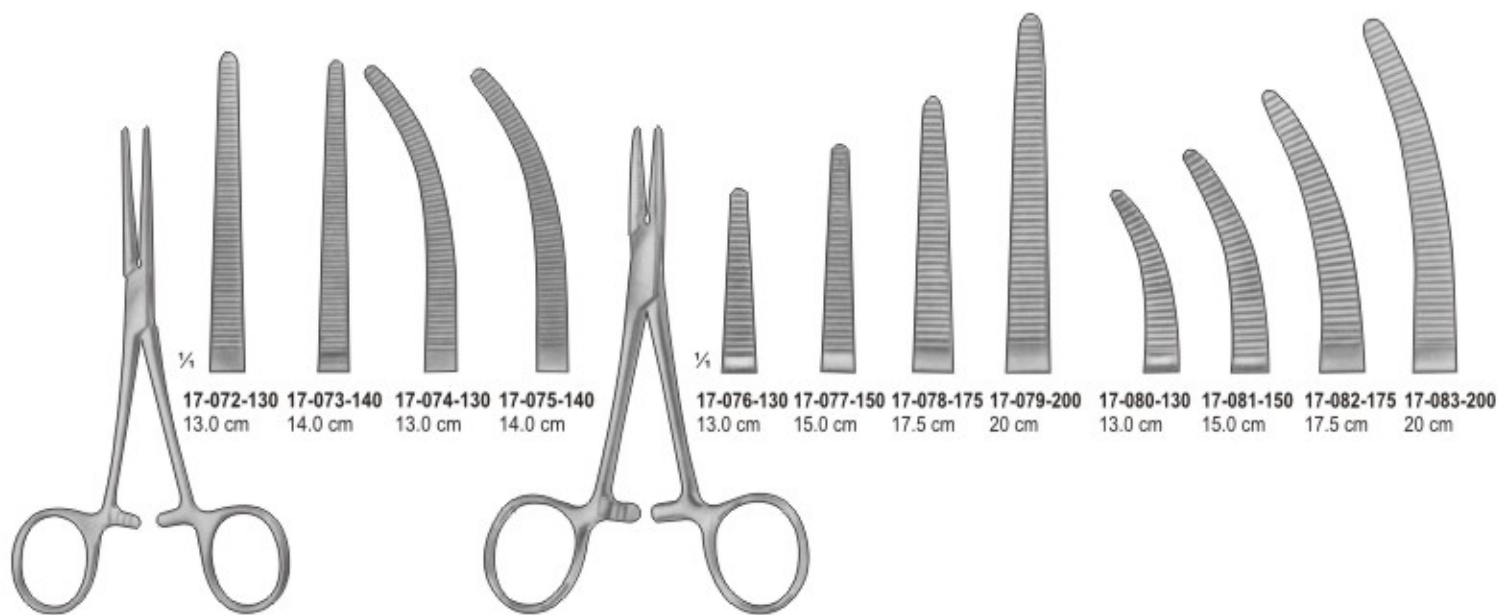

$\frac{1}{4}$   
**17-072-130** **17-073-140** **17-074-130** **17-075-140**  
13.0 cm 14.0 cm 13.0 cm 14.0 cm

**PEAN**  
Slender Type

$\frac{1}{4}$   
**17-076-130** **17-077-150** **17-078-175** **17-079-200** **17-080-130** **17-081-150** **17-082-175** **17-083-200**  
13.0 cm 15.0 cm 17.5 cm 20 cm 13.0 cm 15.0 cm 17.5 cm 20 cm

**SPENCER-WELLS**  
Slender Type

# HAEMOSTATIC FORCEPS

Arterienklemmen  
Pinzas hemostaticas

Pinces hemostatiques  
Pinze emostatiche

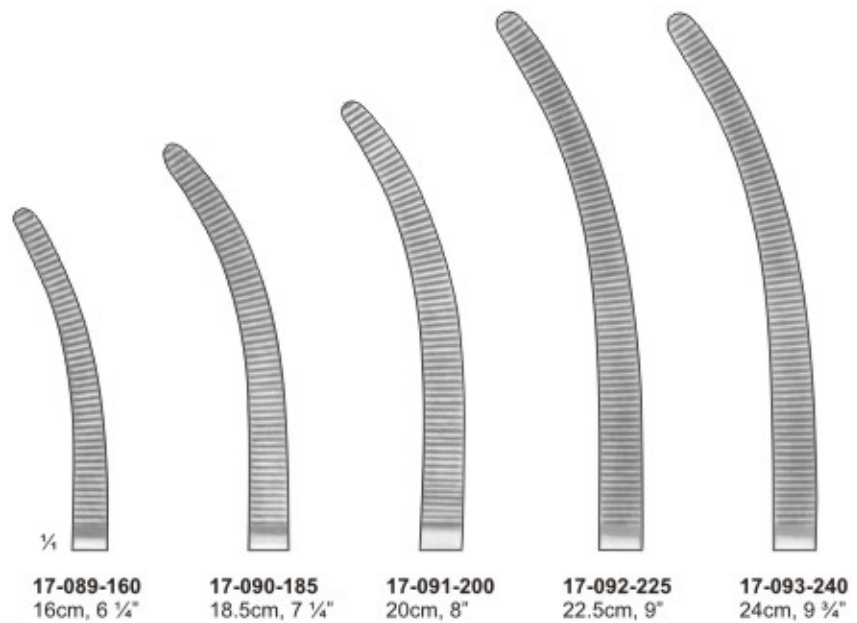
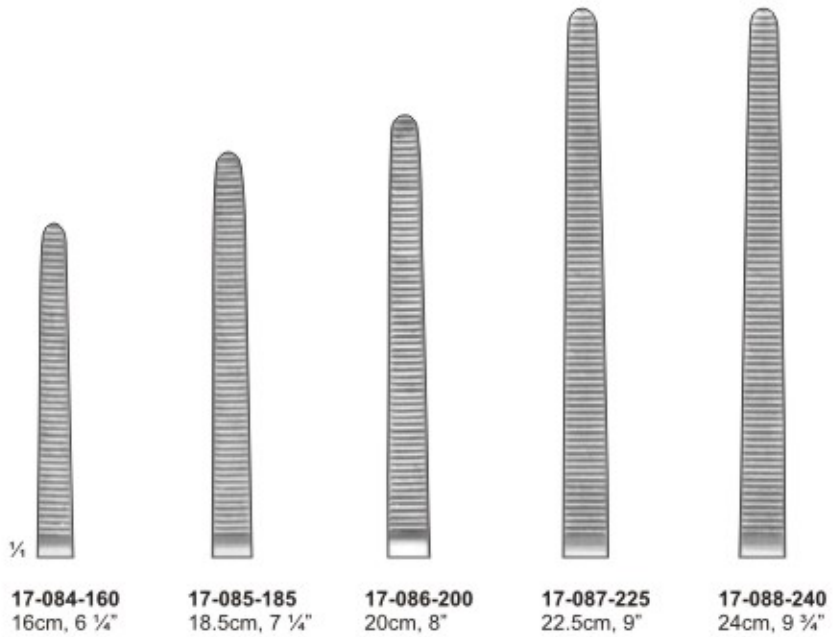

ROCHESTER-PEAN



# HAEMOSTATIC FORCEPS

Arterienklemmen  
Pinzas hemostaticas

Pinces hemostatiques  
Pinze emostatiche



**KOCHER-OCHSNER**



**17-094-160**  
16cm, 6 1/4"



**17-095-185**  
18.5cm, 7 1/4"



**17-096-200**  
20cm, 8"



**17-097-225**  
22.5cm, 9"



**17-098-240**  
24.0cm, 9 3/4"



**17-099-260**  
26cm, 10 1/4"



**17-100-160**  
16cm, 6 1/4"



**17-101-185**  
18.5cm, 7 1/4"



**17-102-200**  
20cm, 8"



**17-103-225**  
22.5cm, 9"



**17-104-240**  
24.0cm, 9 3/4"

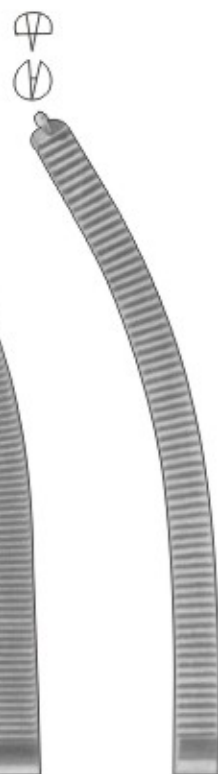

**17-105-260**  
26cm, 10 1/4"

# HAEMOSTATIC FORCEPS



Arterienklemmen  
Pinzas hemostaticas

Pinces hemostatiques  
Pinze emostatiche



**PEAN**

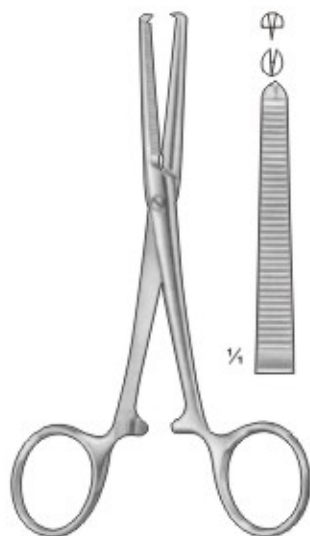
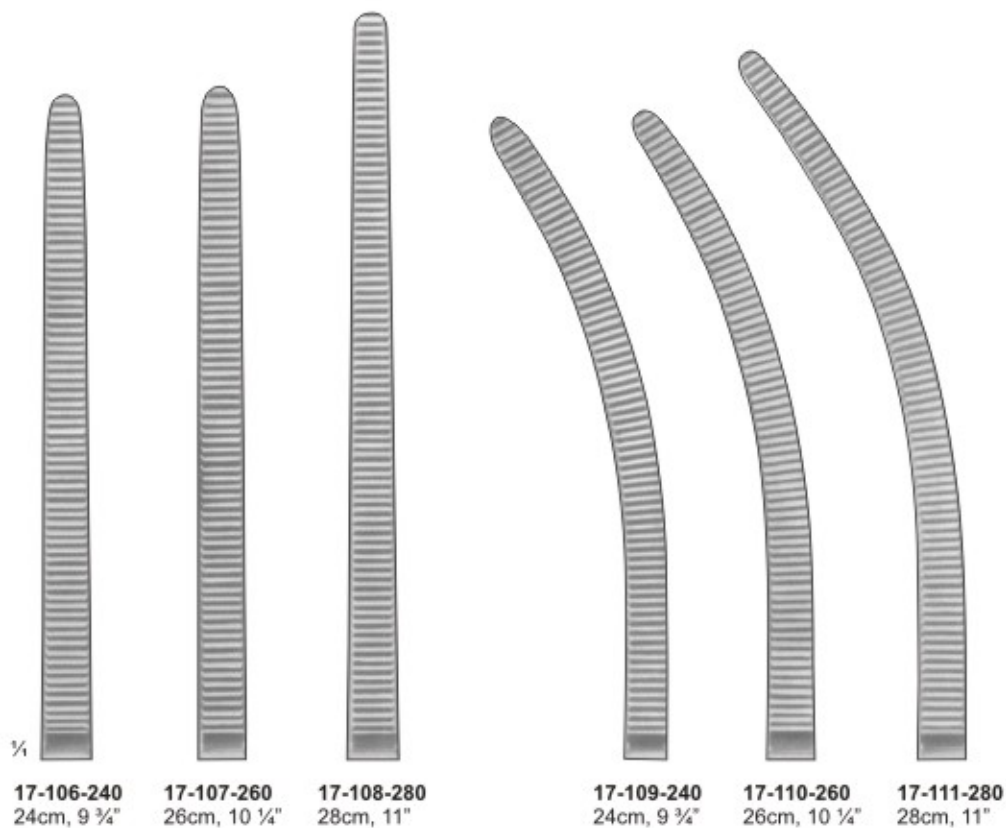

**KOCHER**  
Strong Pattern  
**17-112-145**  
14.5cm, 5 ¾"

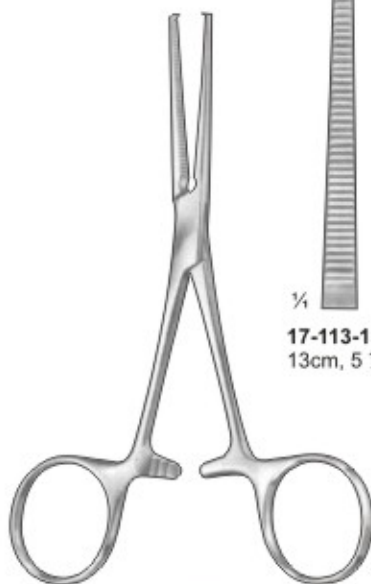

**KOCHER**

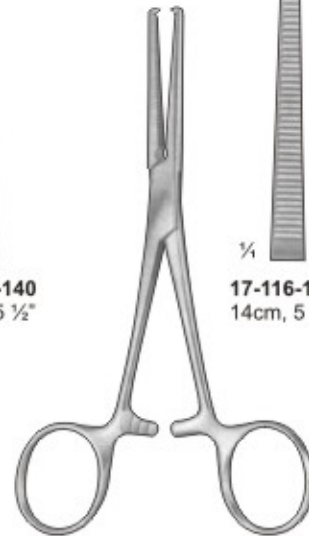
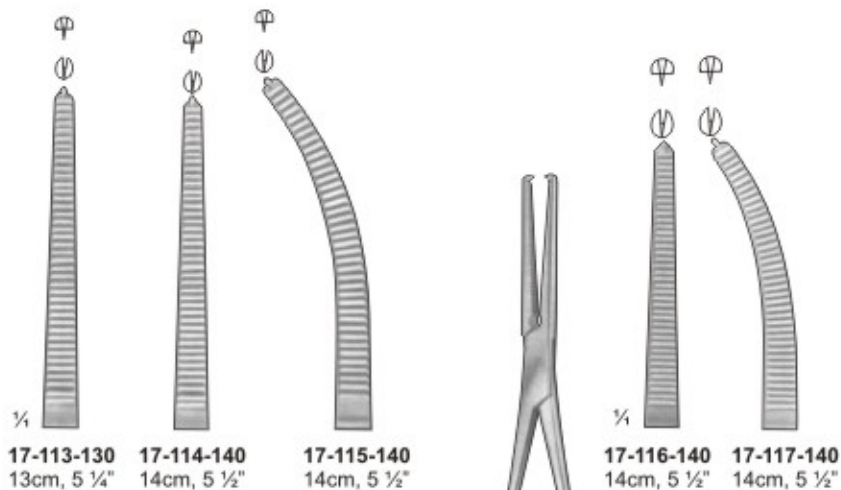

**ROCHESTER-OCHSNER**



# HAEMOSTATIC FORCEPS

Arterienklemmen  
Pinzas hemostaticas

Pinces hemostatiques  
Pinze emostatiche

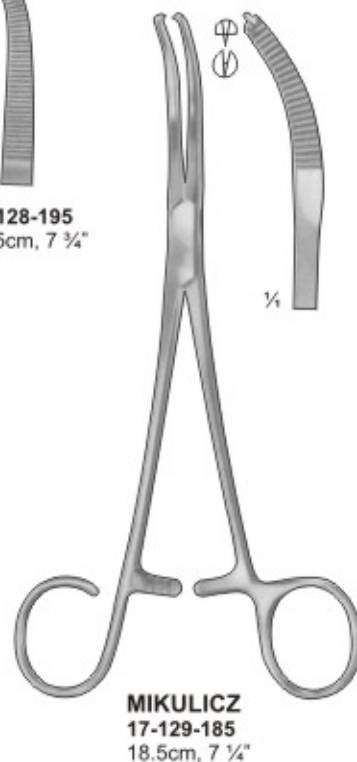
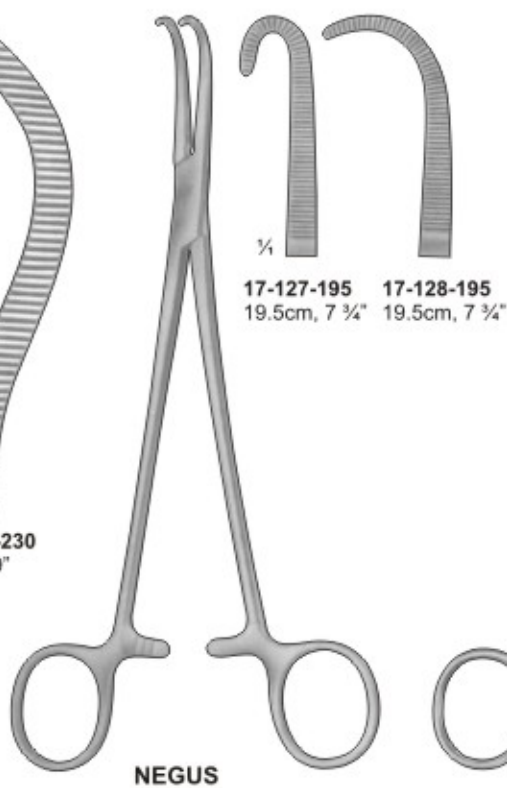
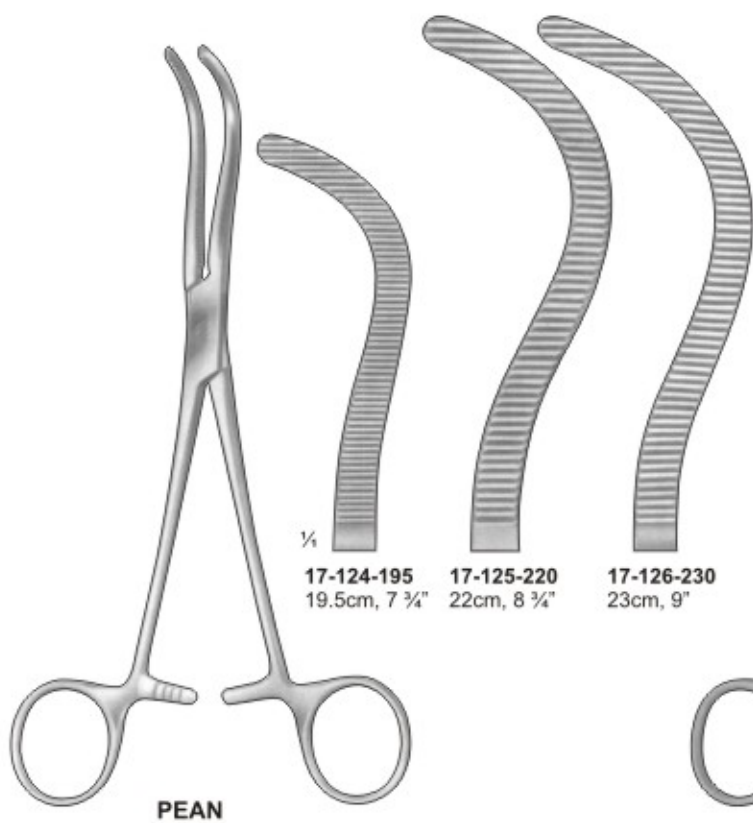
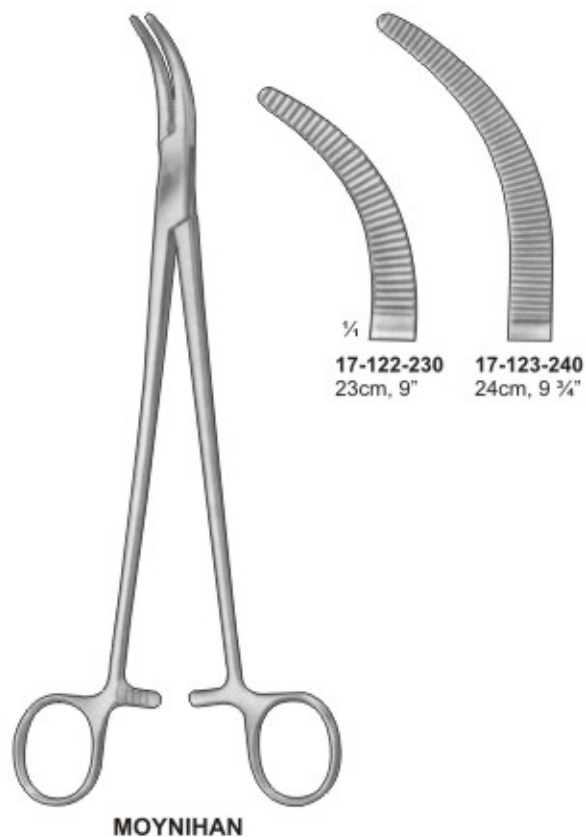

# HAEMOSTATIC FORCEPS



Arterienklemmen  
Pinzas hemostaticas

Pinces hemostatiques  
Pinze emostatiche

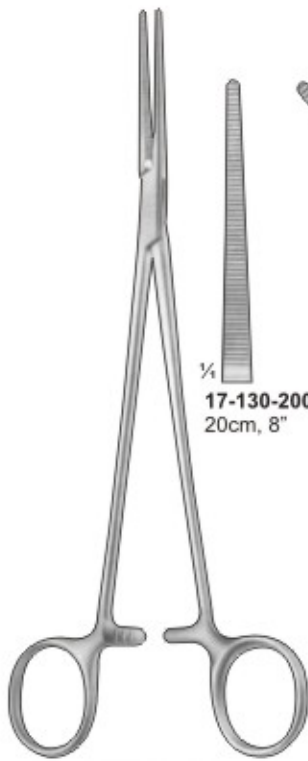

$\frac{1}{4}$   
**17-130-200** 20cm, 8"  
**17-131-200** 20cm, 8"  
 $\Phi$   
 $\Phi$   
**17-132-200** 20cm, 8"  
**17-133-200** 20cm, 8"

**HALSTED-MOSQUITO**

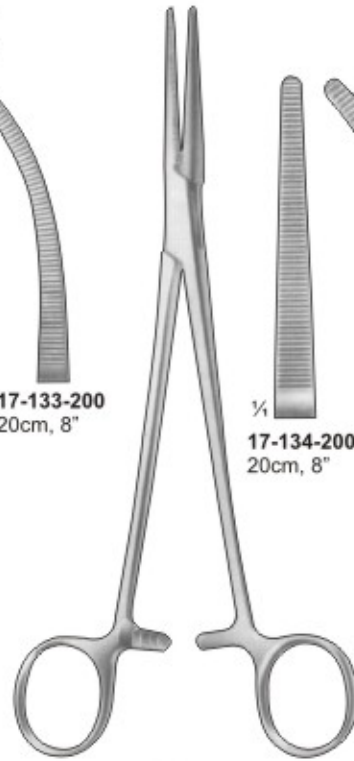

$\frac{1}{4}$   
**17-134-200** 20cm, 8"  
**17-135-200** 20cm, 8"  
**17-136-200** 20cm, 8"  
 $\Phi$   
 $\Phi$   
**17-137-200** 20cm, 8"  
**17-138-200** 20cm, 8"

**HEISS**



$\frac{1}{4}$   
**17-139-215** 21.5cm, 8 1/2"  
 $\Phi$   
 $\Phi$   
**17-140-215** 21.5cm, 8 1/2"

**HALSTED**

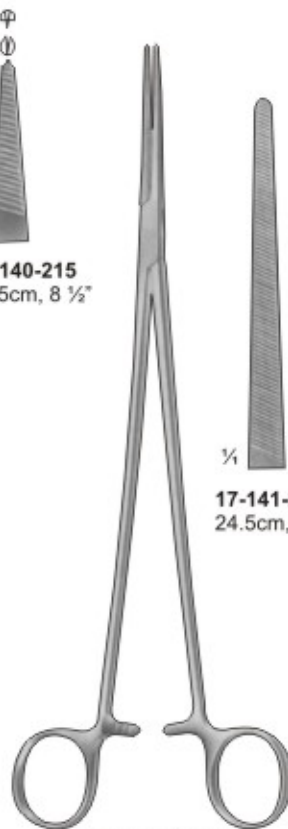

$\frac{1}{4}$   
**17-141-245** 24.5cm, 9 3/4"  
**17-142-245** 24.5cm, 9 3/4"  
 $\Phi$   
 $\Phi$   
**17-143-245** 24.5cm, 9 3/4"  
**17-144-245** 24.5cm, 9 3/4"

**BENGOLEA**

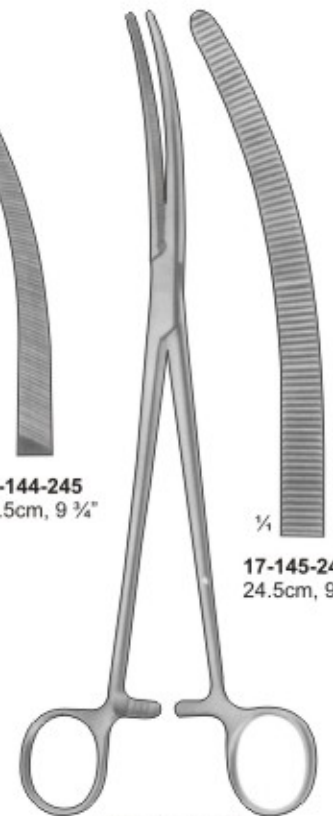

$\frac{1}{4}$   
**17-145-245** 24.5cm, 9 3/4"

**CRAFOORD**





# HAEMOSTATIC FORCEPS

Arterienklemmen  
Pinzas hemostaticas

Pinces hemostatiques  
Pinze emostatiche



¼

**17-146-195**  
19.5cm, 7 ¾"

**17-147-210**  
21cm, 8 ¼"

**17-148-220**  
22cm, 8 ¾"

**17-149-225**  
22.5cm, 9"

**17-150-210**  
21cm, 8 ¼"

**17-151-230**  
23cm, 9"

**17-152-225**  
22.5cm, 9"

**17-153-260**  
26cm, 10 ¼"

**17-154-270**  
27cm, 10 ¾"

**17-155-275**  
27.5cm, 10 ¾"

**17-156-270**  
27cm, 10 ¾"

**17-157-280**  
28cm, 11"

**17-158-280**  
28cm, 11"

**OVERHOLT-GEISSENDOERFER**

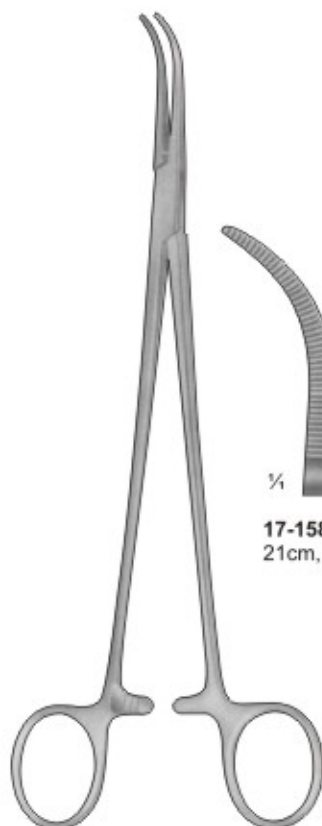

¼

**17-158-210**  
21cm, 8 ¼"

**17-159-215**  
21.5cm, 8 ½"

**17-160-220**  
22cm, 8 ¾"

**17-161-225**  
22.5cm, 9"

**17-162-225**  
22.5cm, 9"

**17-163-295**  
29.5cm, 11 ¾"

**17-164-295**  
29.5cm, 11 ¾"

**17-165-300**  
30cm, 12"

**OVERHOLT**  
Fine Pattern

# HAEMOSTATIC FORCEPS



Arterienklemmen  
Pinzas hemostaticas

Pinces hemostatiques  
Pinze emostatiche

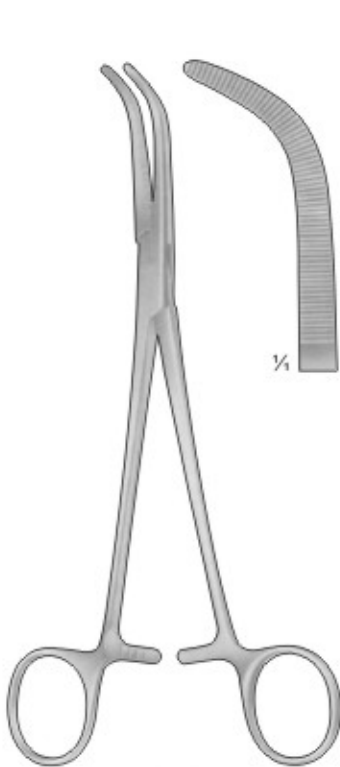

**MIXTER-O'SHAUGNESSY**  
17-166-190  
19cm, 7 1/2"

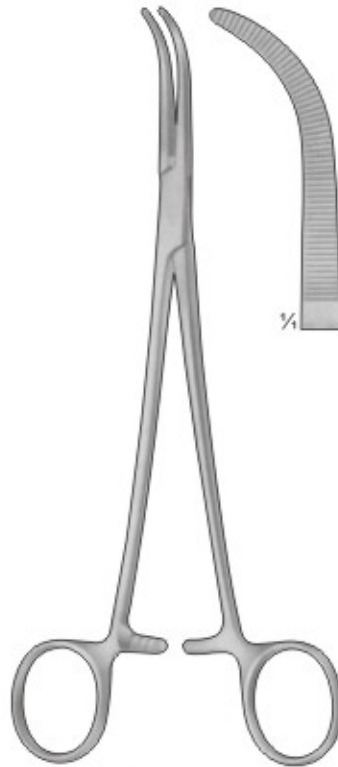

**HEISS**  
17-167-195  
19.5cm, 7 3/4"

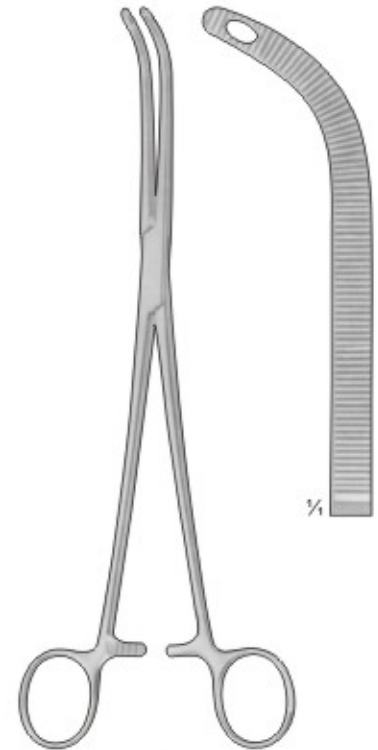

**FINOCHIETTO**  
17-168-245  
24.5cm, 9 1/2"

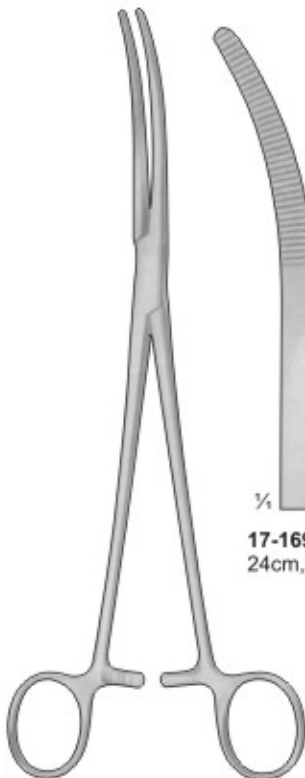

**RUMEL**



**17-169-245**  
24cm, 9 1/2"



**17-170-245**  
24cm, 9 1/2"

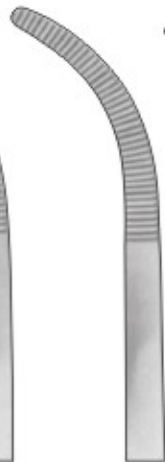

**17-171-245**  
24cm, 9 1/2"



**17-172-245**  
24cm, 9 1/2"



**17-173-245**  
24cm, 9 1/2"

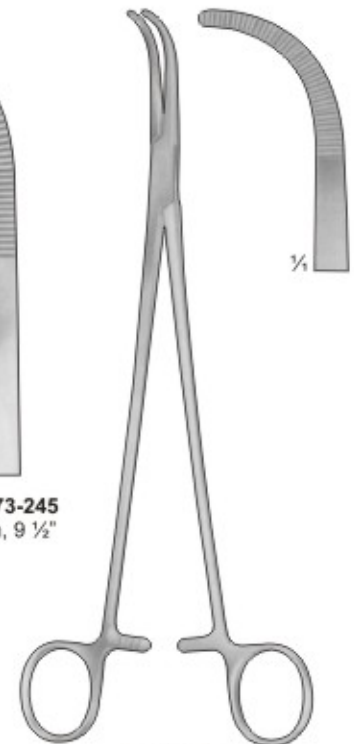

**MIXTER**  
17-174-230  
23cm, 9"



# HAEMOSTATIC FORCEPS

Arterienklemmen  
Pinzas hemostaticas

Pinces hemostatiques  
Pinze emostatiche



**MINI-GEMINI**  
curved, serrated



**17-175-180**  
18 cm, 7"



**17-176-220**  
22 cm, 8 3/4"



**17-177-250**  
25 cm, 10"



**17-178-280**  
28 cm, 11"



**GEMINI**  
Curved, Serrated



**17-179-130**  
13 cm, 5"



**17-180-160**  
16 cm, 6 1/4"



**17-181-180**  
18 cm, 7"



**17-182-200**  
20 cm, 8"

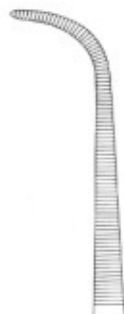

**17-183-230**  
23 cm, 9"



**17-184-250**  
25 cm, 10"



**17-185-280**  
28 cm, 11"

# HAEMOSTATIC FORCEPS



Arterienklemmen  
Pinzas hemostaticas

Pinces hemostatiques  
Pinze emostatiche



**LAWRENCE**  
17-186-270  
27cm, 10 3/4"

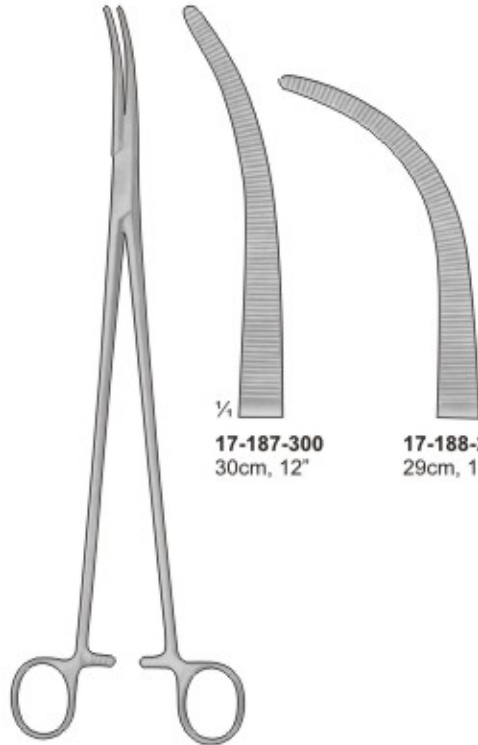

**ZENKER**

17-187-300  
30cm, 12"

17-188-290  
29cm, 11 1/2"



**BAINBRIDGE**

17-189-150  
15 cm, 5 3/4"  
17-190-185  
18.5 cm, 7 1/4"

17-191-150  
15 cm, 5 3/4"  
17-192-185  
18.5 cm, 7 1/4"



**BRIDGE**  
17-193-280  
28 cm, 11"  
Curved, Serrated

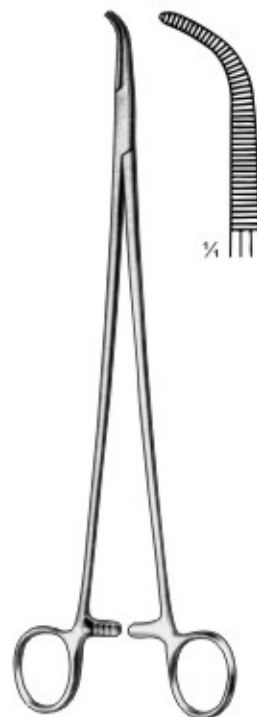

**LAWRENCE**  
17-194-280  
28.0 cm, 11"

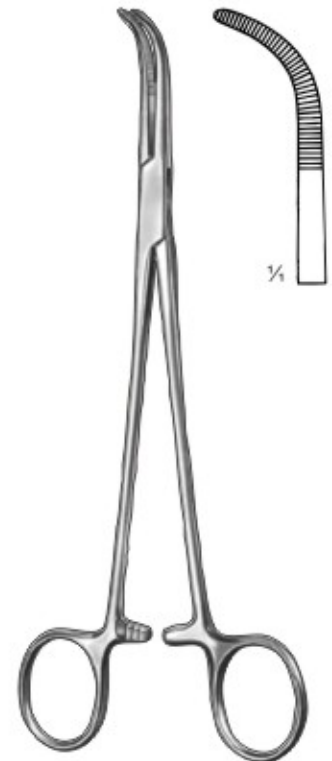

**KANTROWITZ**  
17-195-200 20 cm, 8"  
17-196-240 24 cm, 9 1/2"  
17-197-280 28 cm, 11"  
Right Angle, Serrated



# HAEMOSTATIC FORCEPS

Arterienklemmen  
Pinzas hemostaticas

Pinces hemostatiques  
Pinze emostatiche

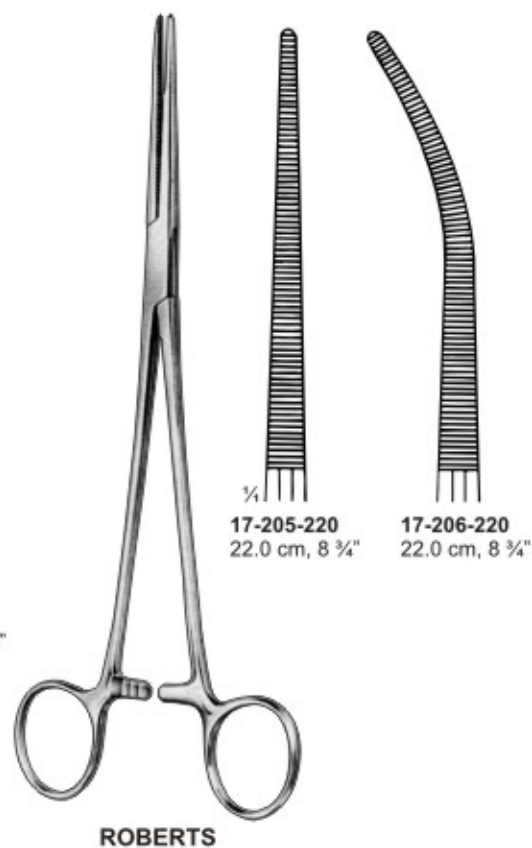
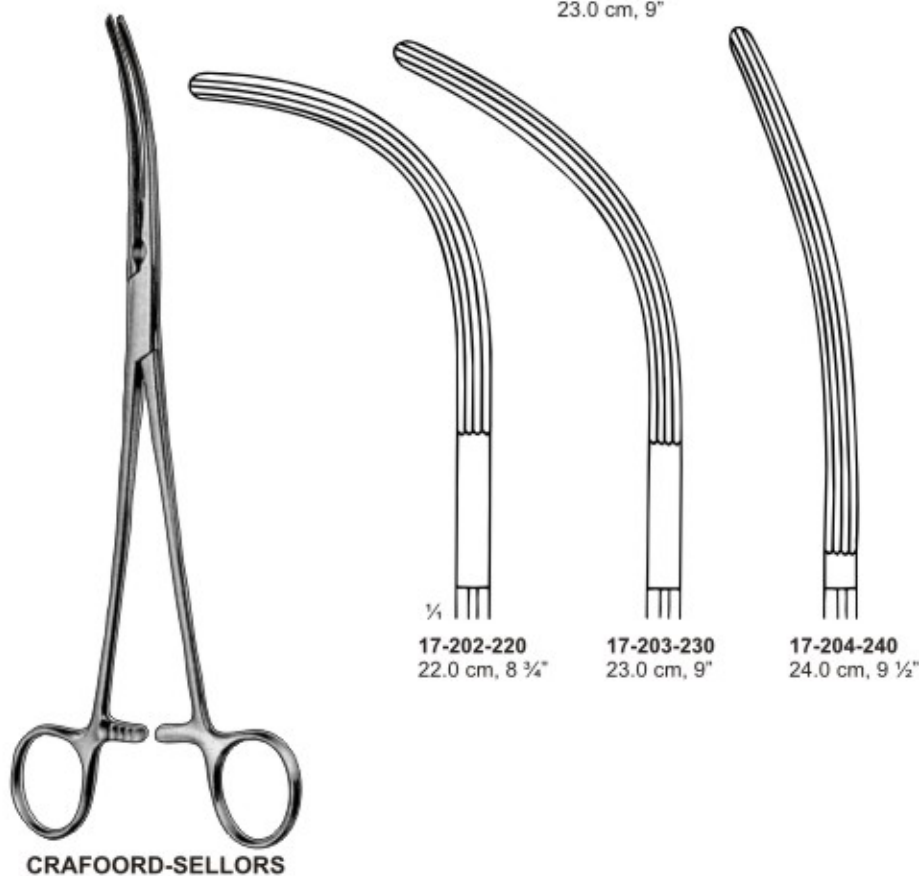
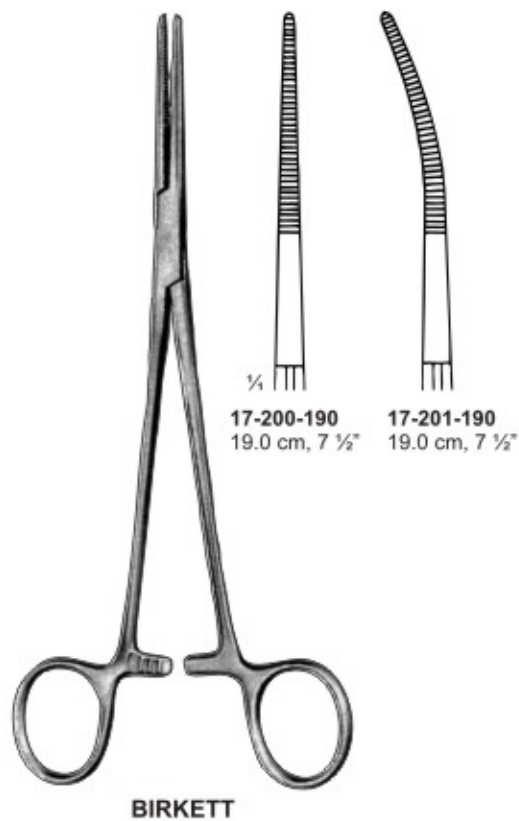
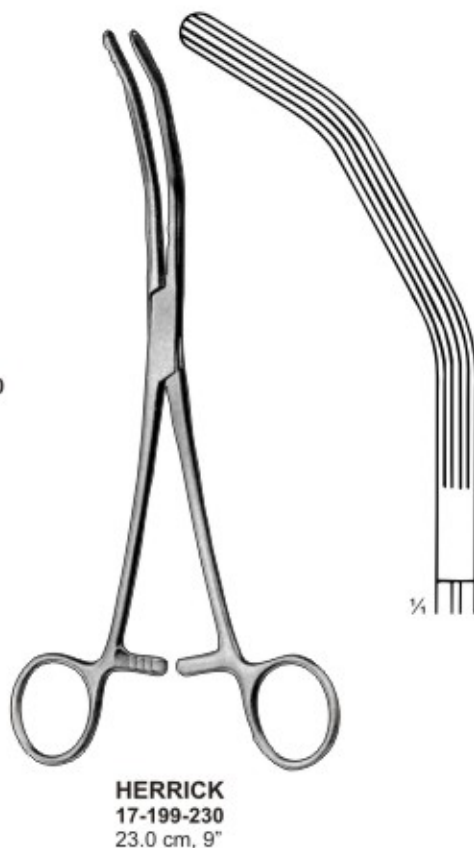

# HAEMOSTATIC FORCEPS



Arterienklemmen  
Pinzas hemostaticas

Pinces hemostatiques  
Pinze emostatiche



**WIKSTROEM**  
17-207-190  
19.0 cm, 7 1/2"

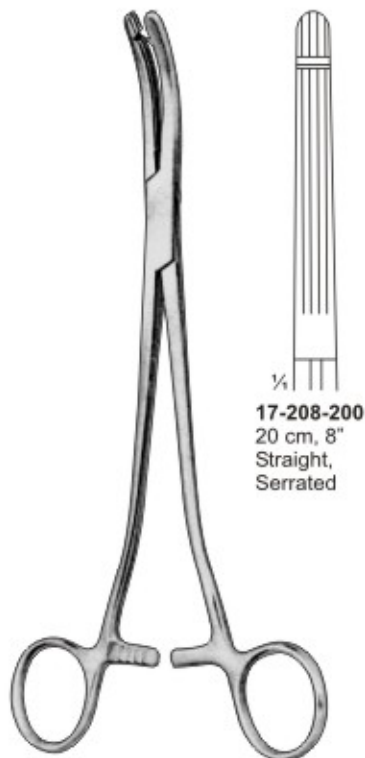

**HEANEY / BALLANTINE**

17-208-200  
20 cm, 8"  
Straight,  
Serrated

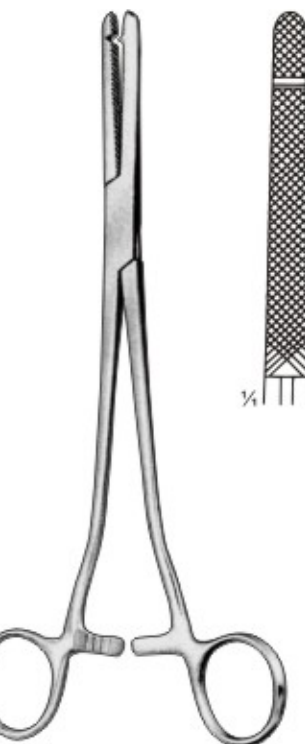

**HEANEY / REZAK**  
17-210-210 21 cm, 8 1/4"  
Straight, Cross Serrated

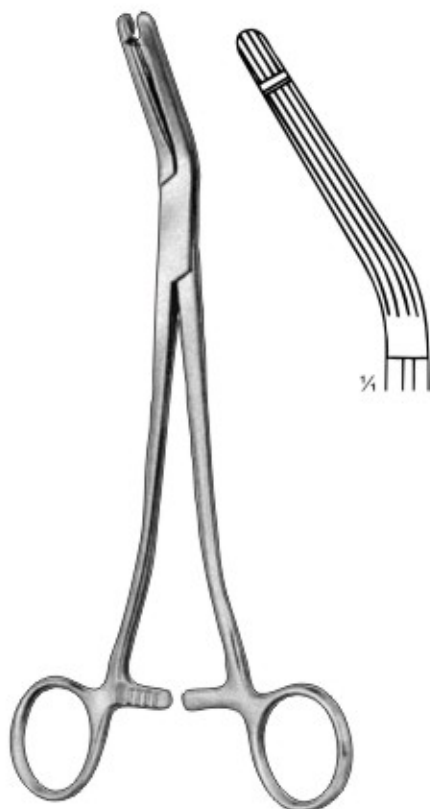

**GARLAND**  
17-211-210  
21 cm, 8 1/4"



**DIXON-LOVELACE 1:2**  
17-212-155 15.5 cm, 6"

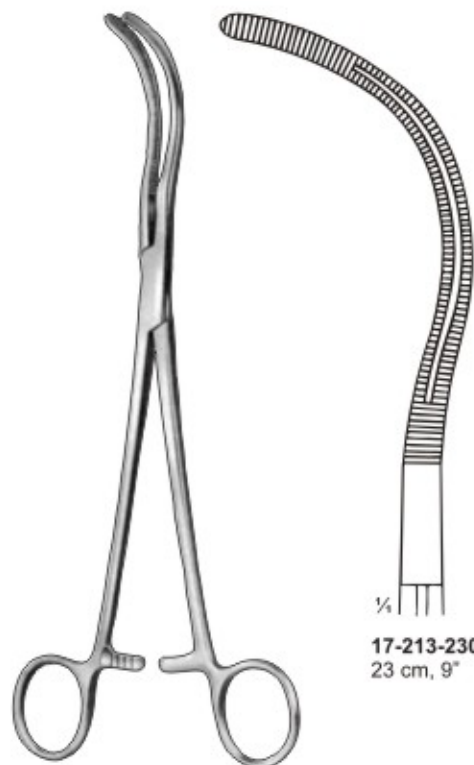

**STILLE**

17-213-230  
23 cm, 9"



# HAEMOSTATIC FORCEPS

Arterienklemmen  
Pinzas hemostaticas

Pinces hemostatiques  
Pinze emostatiche

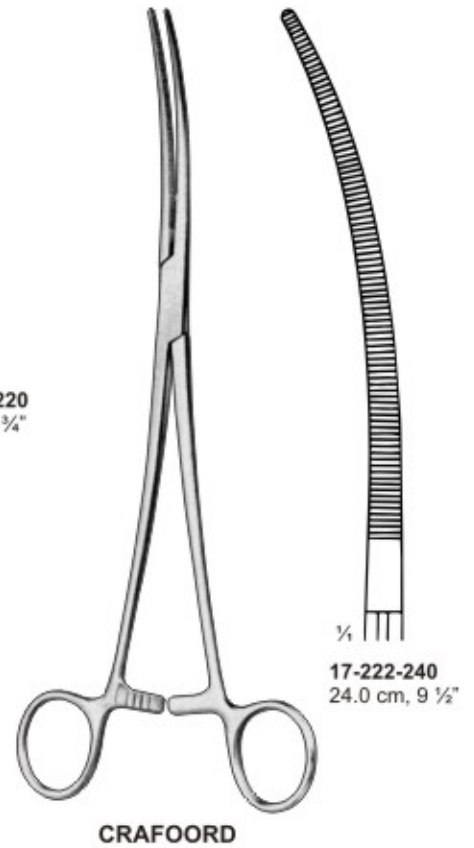
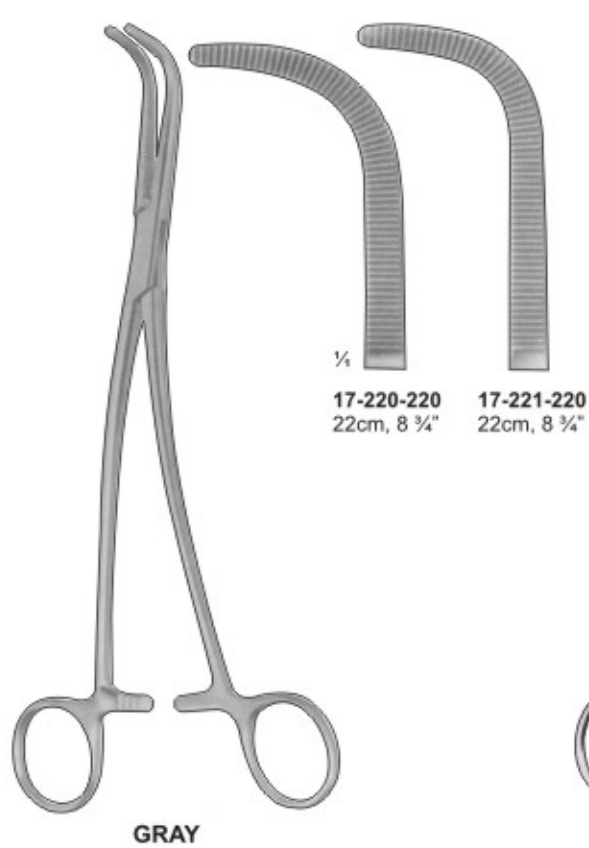
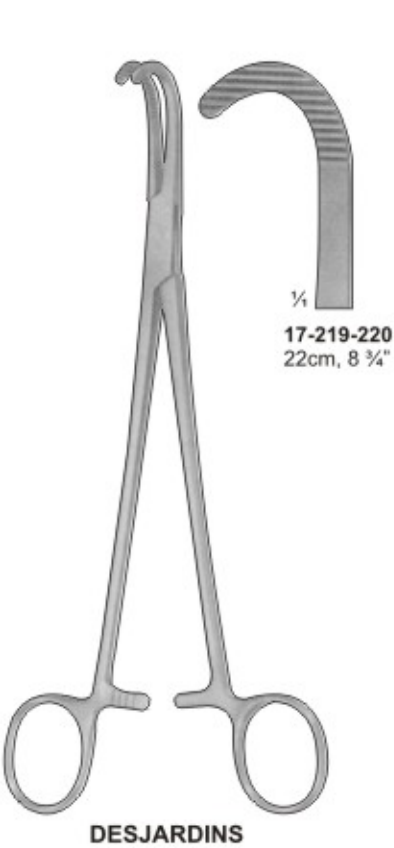
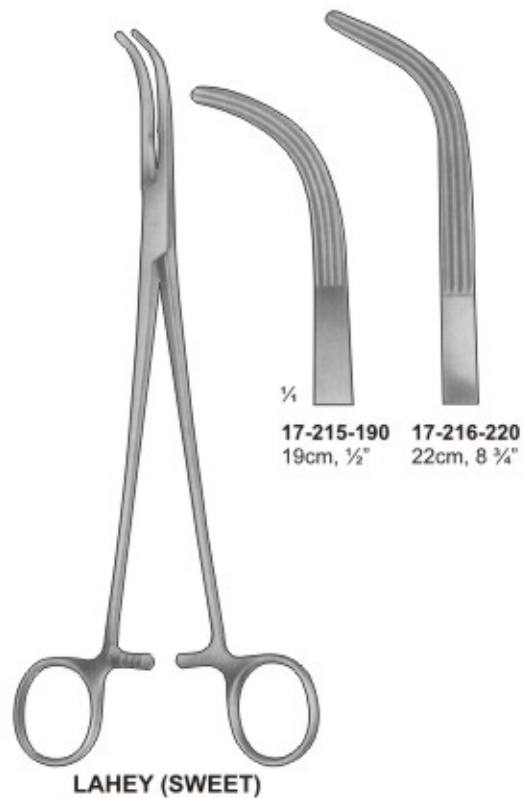
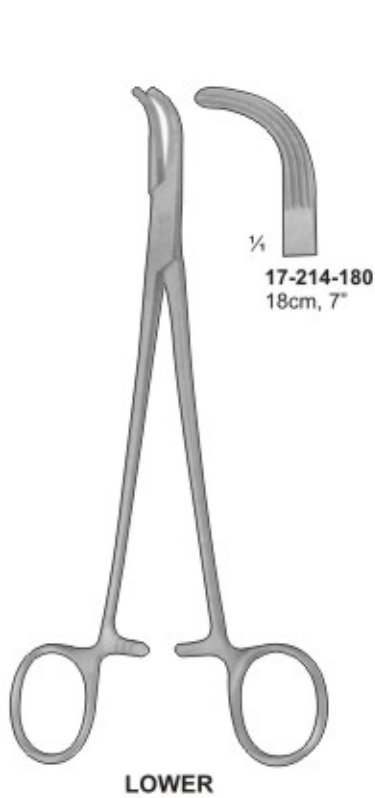

# HAEMOSTATIC FORCEPS



Arterienklemmen  
Pinzas hemostaticas

Pinces hemostatiques  
Pinze emostatiche



GUYON



¼  
17-223-200  
20 cm, 8"



¼  
17-224-220  
22 cm, 8 ½"

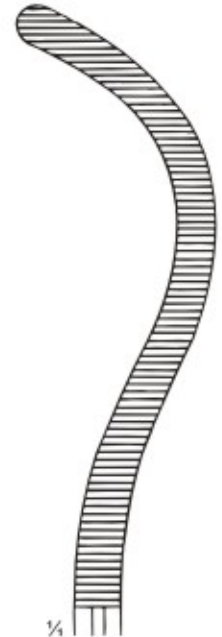

¼  
17-225-240  
24 cm, 9 ½"



GUYON



¼  
17-226-230  
23 cm, 9"



¼  
17-227-240  
24 cm, 9 ½"



GUYON

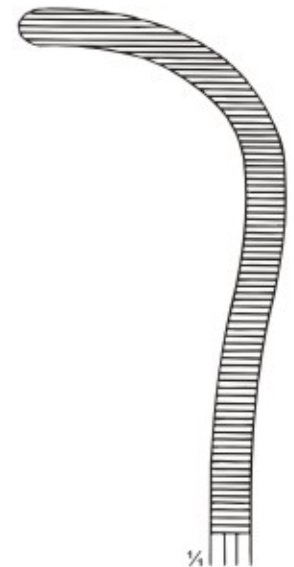

¼  
17-228-230  
23 cm, 9"





# HAEMOSTATIC FORCEPS

Arterienklemmen  
Pinzas hemostaticas

Pinces hemostatiques  
Pinze emostatiche

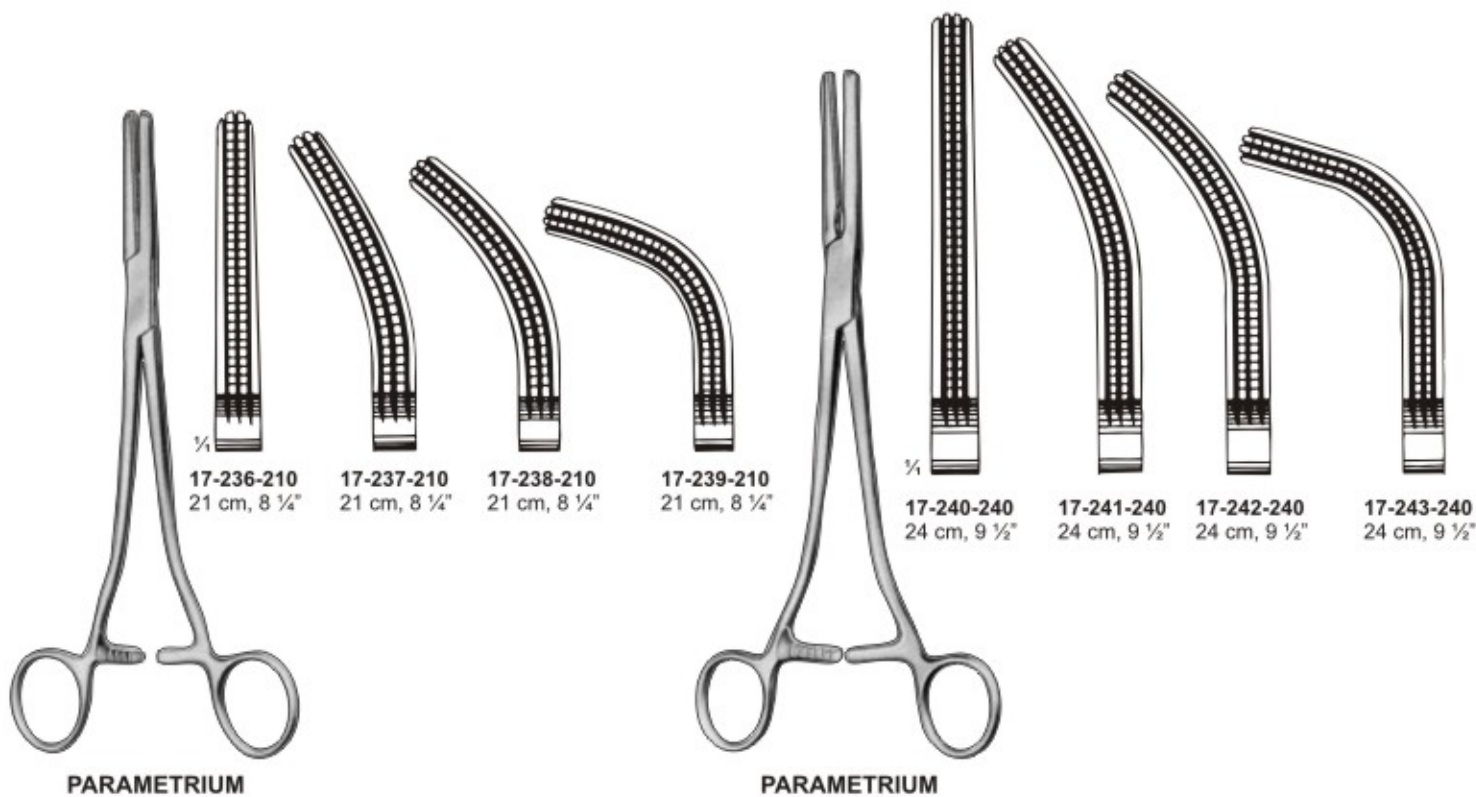
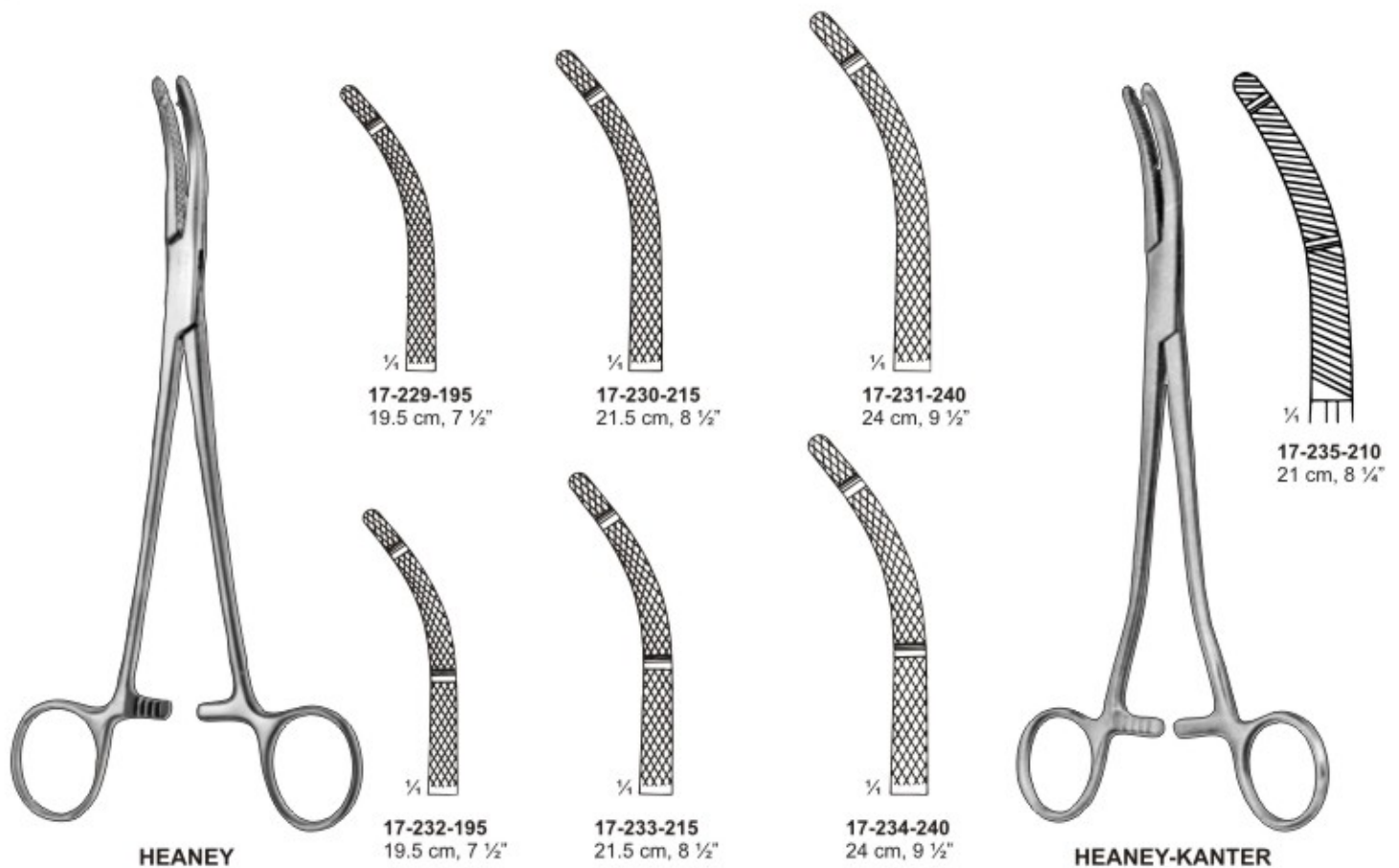

# HAEMOSTATIC FORCEPS



Arterienklemmen  
Pinzas hemostaticas

Pinces hemostatiques  
Pinze emostatiche

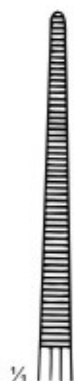
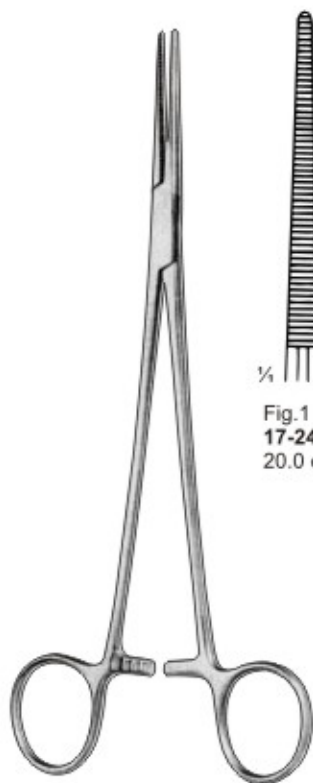

Fig.1  
17-244-200  
20.0 cm, 8"



Fig.2  
17-245-200  
20.0 cm, 8"



Fig.3  
17-246-200  
20.0 cm, 8"

HEISS



17-247-200  
20.0 cm, 8"

JOHN HOPKINS

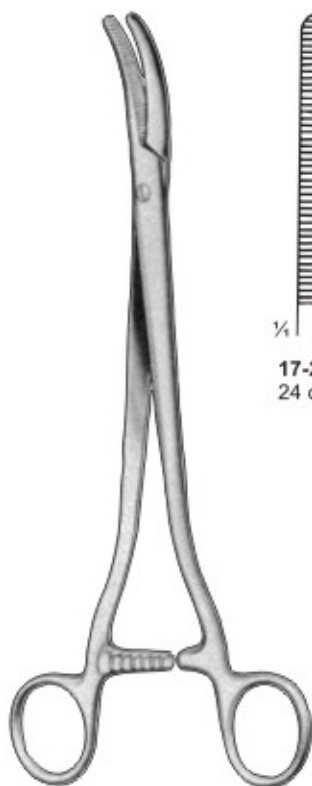

17-248-240  
24 cm, 9 1/2"



17-249-240  
24 cm, 9 1/2"

SEGOND-LANDAU

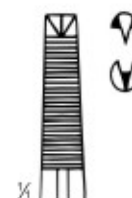

17-250-200  
20 cm, 8"

SCHINDLER 1:2



# HAEMOSTATIC FORCEPS

Arterienklemmen  
Pinzas hemostaticas

Pinces hemostatiques  
Pinze emostatiche



¼  
**17-251-260**  
26 cm, 10 ¼"  
Curved,  
Serrated

**BOZEMANN**



¼  
**17-252-260**  
26 cm, 10 ¼"

**BOZEMANN-DOUGLAS**



¼  
**17-253-260**  
26 cm, 10 ¼"

**BOZEMANN**



¼  
**17-254-230**  
23 cm, 9"

**WESTERMARK**

# HAEMOSTATIC FORCEPS



Arterienklemmen  
Pinzas hemostaticas

Pinces hemostatiques  
Pinze emostatiche



GRAY



17-255-220  
22 cm, 8 1/2"

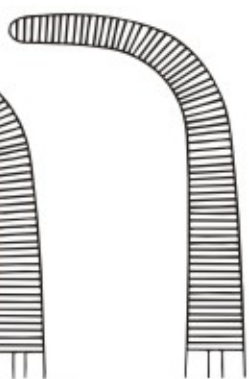

17-256-230  
23 cm, 9"

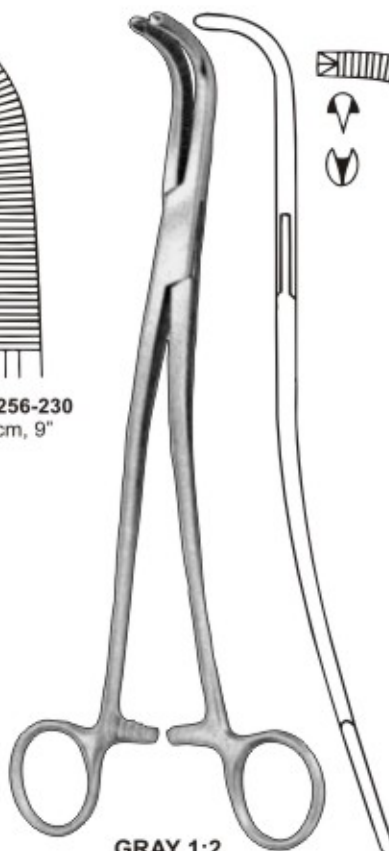

GRAY 1:2

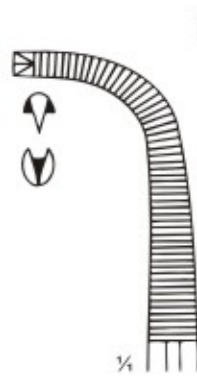

17-257-220  
22 cm, 8 1/2"

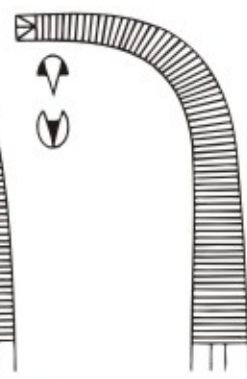

17-258-230  
23 cm, 9"



PHANEUF 1:2



17-259-215  
21.5 cm, 8 1/2"



17-260-215  
21.5 cm, 8 1/2"



LONG  
17-261-190  
19.0 cm, 7 1/2"





# HAEMOSTATIC FORCEPS

Arterienklemmen  
Pinzas hemostaticas

Pinces hemostatiques  
Pinze emostatiche



**BABY-MIKULICZ**  
17-262-140  
14cm, 5 1/2"

**MIKULICZ**  
17-263-185  
18.5cm, 7 1/4"

**MIKULICZ**  
17-264-205  
20.5cm, 8"

**MIKULICZ**  
17-265-200  
20cm, 8"

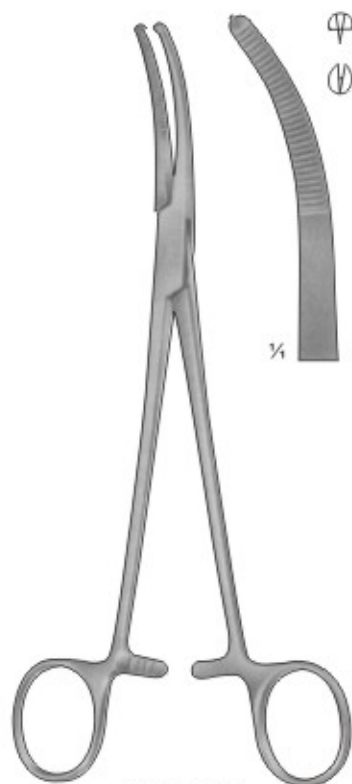

**MIKULICZ**  
17-266-205  
20.5cm, 8"

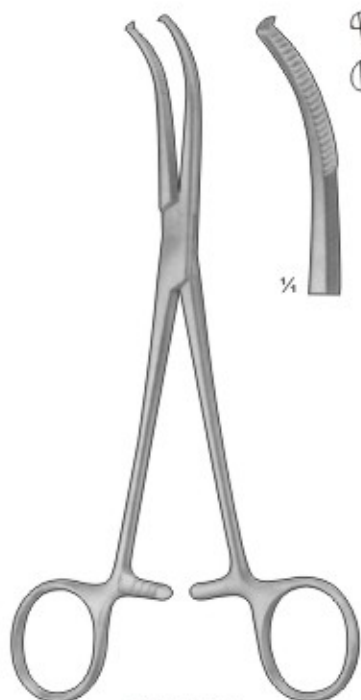

**MIKULICZ**  
17-267-205  
20.5cm, 8"

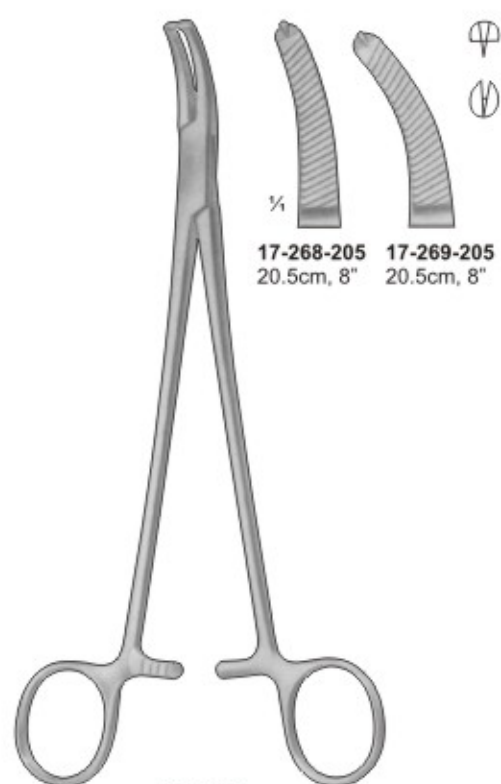

**17-268-205** 20.5cm, 8"  
**17-269-205** 20.5cm, 8"

**FAURE**

# HAEMOSTATIC FORCEPS



Arterienklemmen  
Pinzas hemostaticas

Pinces hemostatiques  
Pinze emostatiche

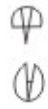
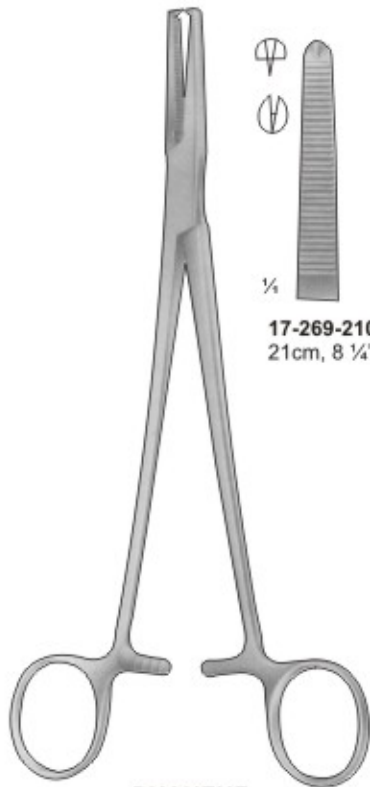

¼

**17-269-210**  
21cm, 8 ¼"

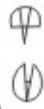
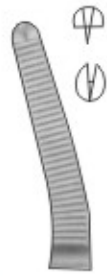

**17-270-205**  
20.5cm, 8"

**PHANEUF**

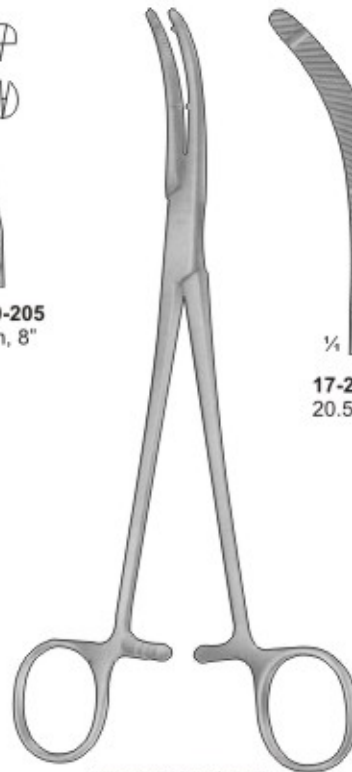

¼

**17-271-205**  
20.5cm, 8"



**17-272-245**  
24.5cm, 9 ¾"

**HEANEY MODIF.**

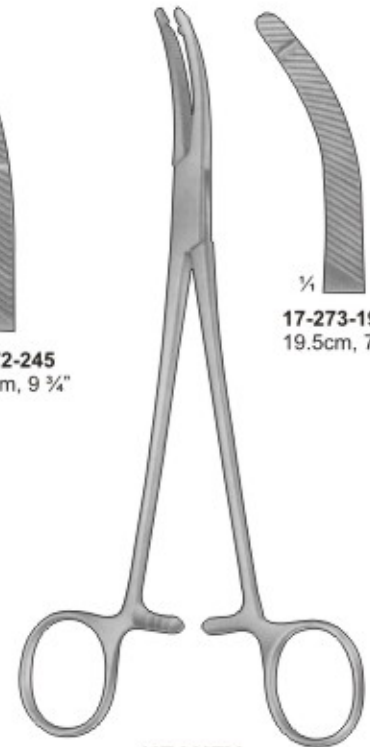

¼

**17-273-195**  
19.5cm, 7 ¾"

**HEANEY**

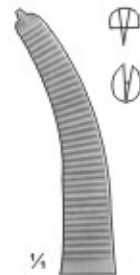
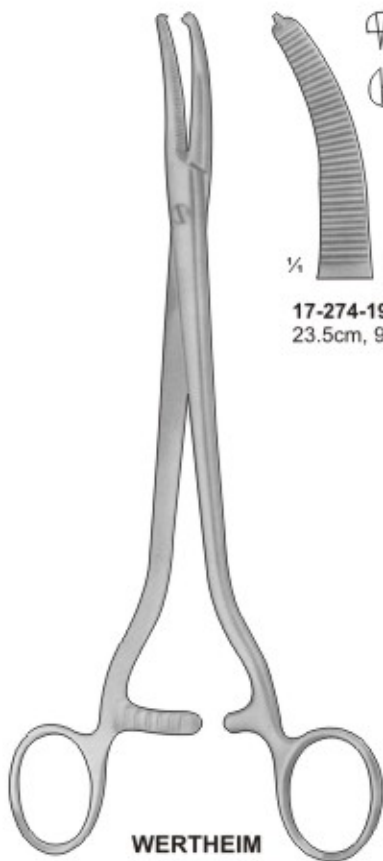

¼

**17-274-195**  
23.5cm, 9 ¼"

**WERTHEIM**

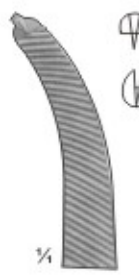
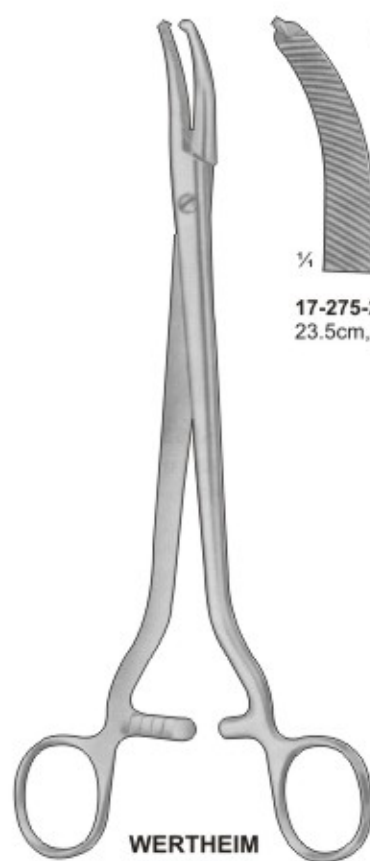

¼

**17-275-235**  
23.5cm, 9 ¼"

**WERTHEIM**

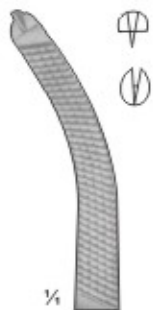
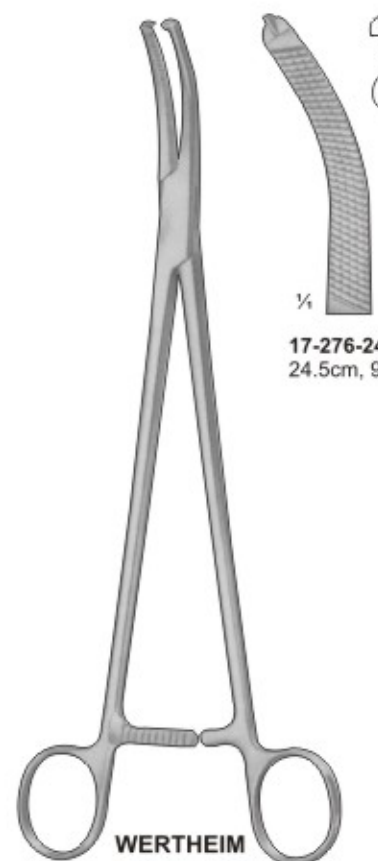

¼

**17-276-245**  
24.5cm, 9 ¾"

**WERTHEIM**



## HAEMOSTATIC FORCEPS

Arterienklemmen  
Pinzas hemostaticas

Pinces hemostatiques  
Pinze emostatiche

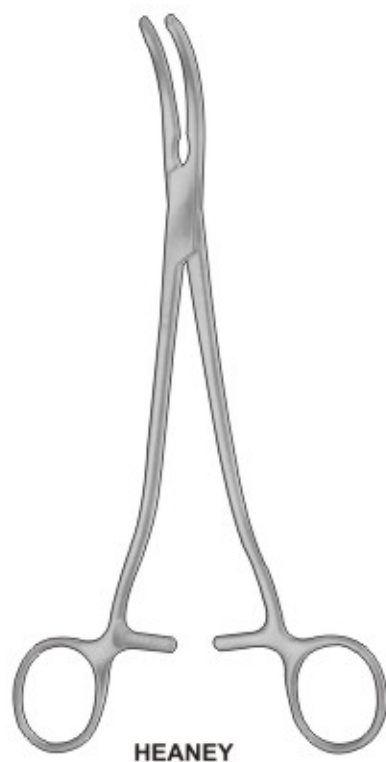

**HEANEY**



17-277-225  
22.5cm, 9"



17-278-220  
22cm, 8 3/4"



17-279-215  
21.5cm, 8 1/2"



17-280-205  
20.5cm, 8"



**WERTHEIM**  
Parametrium Clamps



17-281-250  
25cm, 10"



17-282-245  
24.5cm, 9 3/4"



17-283-240  
24cm, 9 1/2"



17-284-220  
22cm, 8 3/4"

# HAEMOSTATIC FORCEPS

Arterienklemmen  
Pinzas hemostaticas

Pinces hemostatiques  
Pinze emostatiche

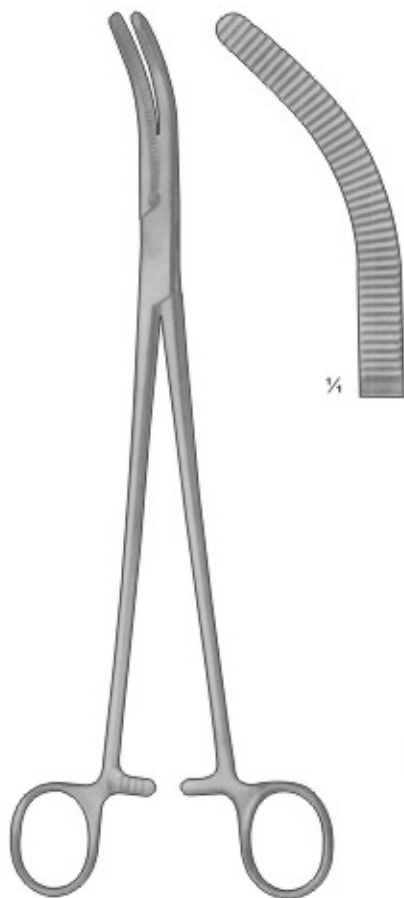

**WERTHEIM**  
Hysterectomy Forceps  
17-285-255  
25.5cm, 10"

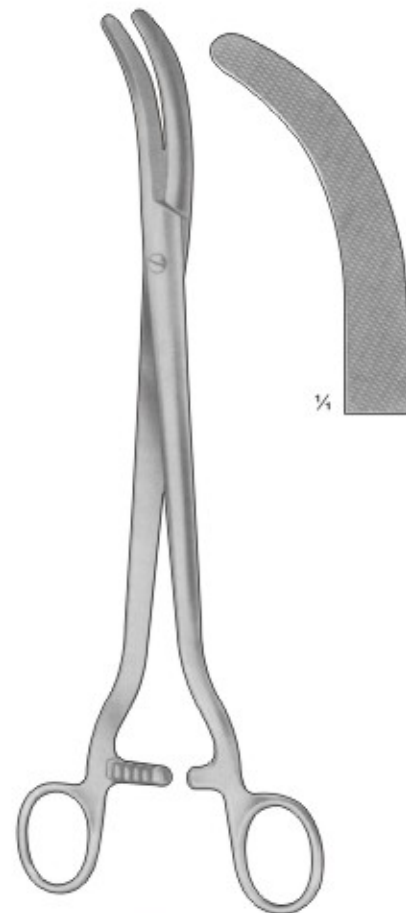

**WERTHEIM**  
Parametrium Clamp  
17-286-260  
26cm, 10 1/4"

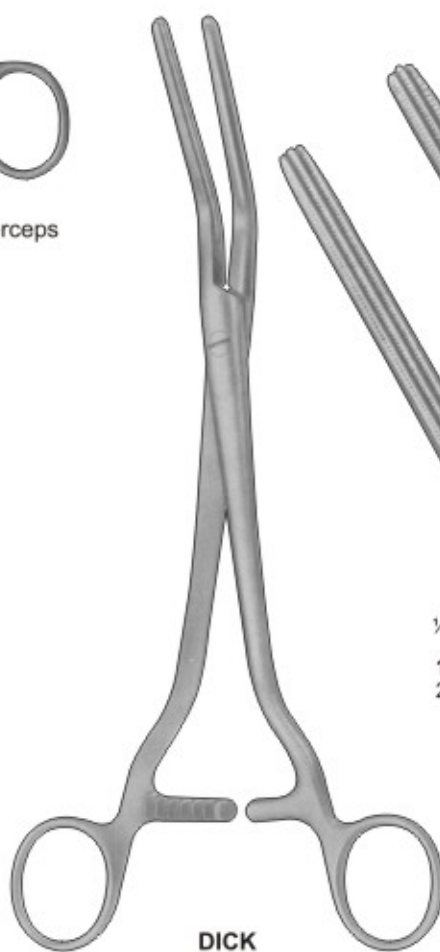

**DICK**



17-287-255  
25.5cm, 10"

17-288-265  
26.5cm, 10 1/2"

17-289-275  
27.5cm, 10 3/4"





# HAEMOSTATIC FORCEPS

Arterienklemmen  
Pinzas hemostaticas

Pinces hemostatiques  
Pinze emostatiche



**WERTHEIM-CULLEN**  
17-290-215  
21.5cm, 8 1/2"

1/4



**WERTHEIM-CULLEN**  
23cm, 9"



**17-293-002**  
80mm

1/4

**17-292-001**  
60mm



**WERTHEIM**  
17-294-250  
25cm, 10"

1/4

# TOWEL FORCEPS



Tuchklemmen  
Pinzas de campo

Pinces à champs  
Pinze fissatele



**JONES /  
PERFORATING**  
17-295-090  
9 cm, 3 1/2"  
Slight Curve



**ENGL. MODELL**  
17-296-090  
9 cm, 3 1/2"



**SCHAEDEL**  
17-297-090  
9 cm, 3 1/2"

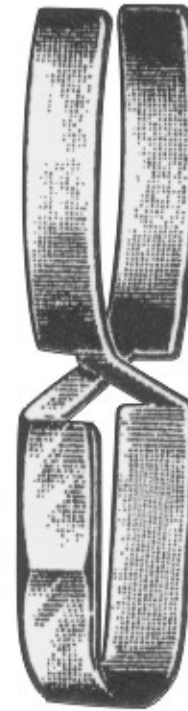

**THOMSON-WALKER'S  
PENILE CLAMPS**  
17-298-090  
9 cm, 3 1/2"  
Cross-Action model.



**DOYEN**  
17-299-180  
18 cm, 7"

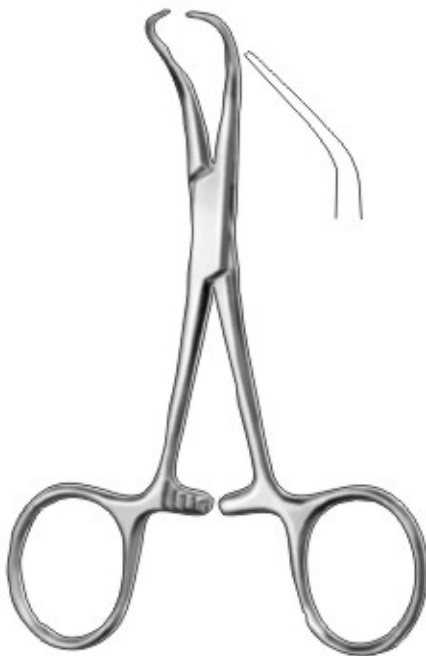

**BACKHAUS**  
17-300-080 8 cm, 3"  
17-301-110 11 cm, 4 1/2"  
17-302-130 13 cm, 5"  
17-303-150 15 cm, 5 3/4"  
Curved



**ROEDER**  
17-304-130 13 cm, 5"  
17-305-150 15 cm, 6"  
Curved, Serrated

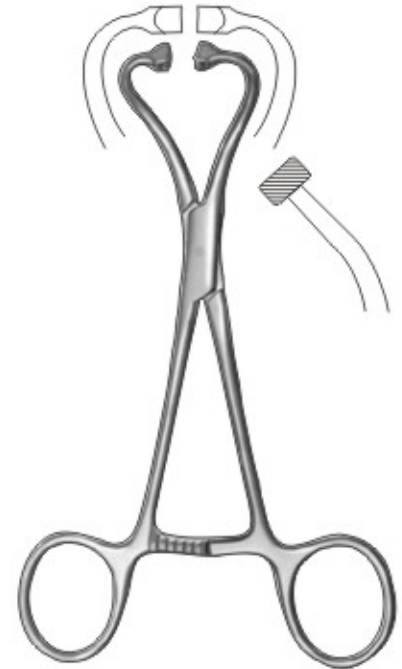

**NON-PERFORATING**  
17-306-110 11 cm, 4 1/2"  
17-307-130 13 cm, 5"



## TOWEL FORCEPS

Tuchklemmen  
Pinzas de campo

Pinces à champs  
Pinze fissatele

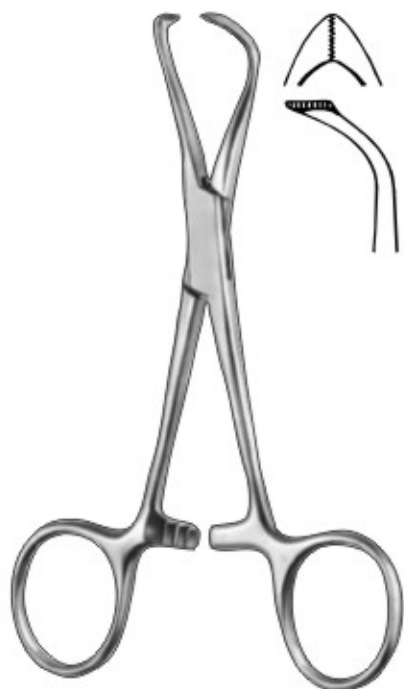

**LORNA**  
17-308-100 10 cm, 4"  
17-309-110 11 cm, 4 ½"  
17-310-130 13 cm, 5"



**BACKHAUS CLIP**  
17-311-110 11 cm, 4 ½"  
with clip for tubing or  
cable



**BALL & SOCKET**  
17-312-130 13 cm, 5"  
Non-perforating

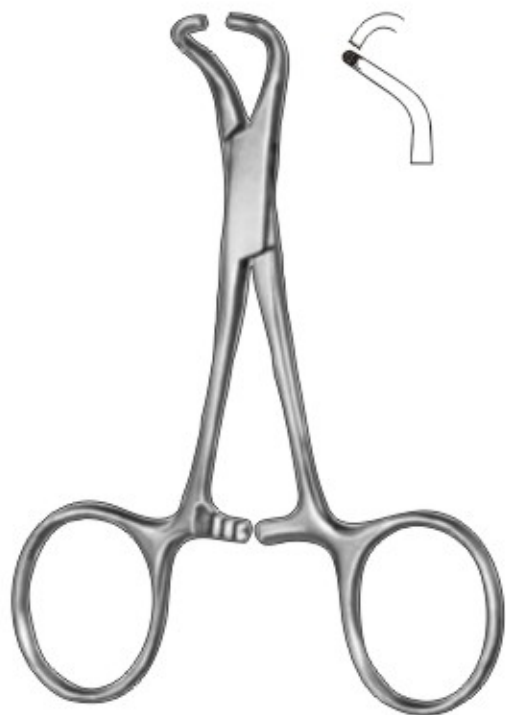

**TOHOKU**  
17-313-100 10cm, 4"  
17-314-130 13cm, 5"  
Non-Perforating

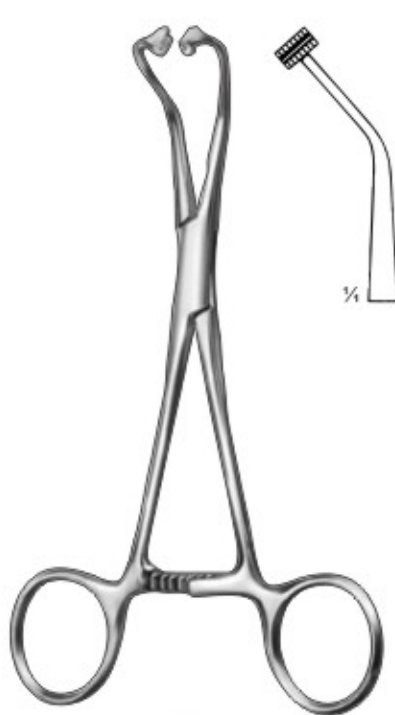

**PEERS-BERTMAN**  
17-315-145  
14.5 cm, 5 ¾"  
Serrated



**BERNHARD**  
17-316-165  
16.5 cm, 6 ½"

# TUBING CLAMP



schlauchklemmen  
Pinzas para tubos

Pinces presse-Tubes  
Pinze serratubi

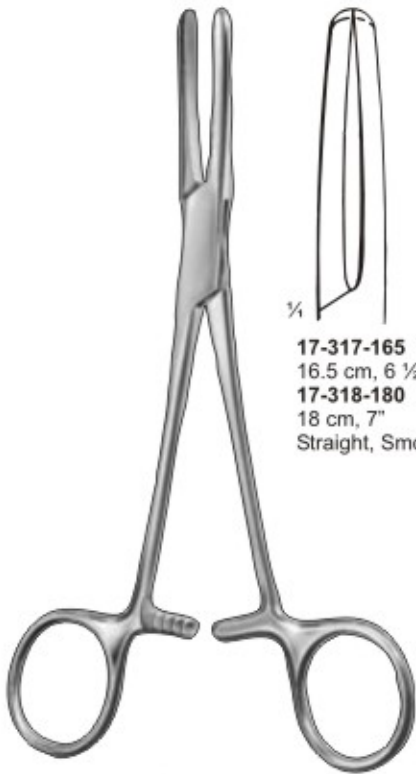

17-317-165  
16.5 cm, 6 1/2"  
17-318-180  
18 cm, 7"  
Straight, Smooth

PRESBYTERIAN

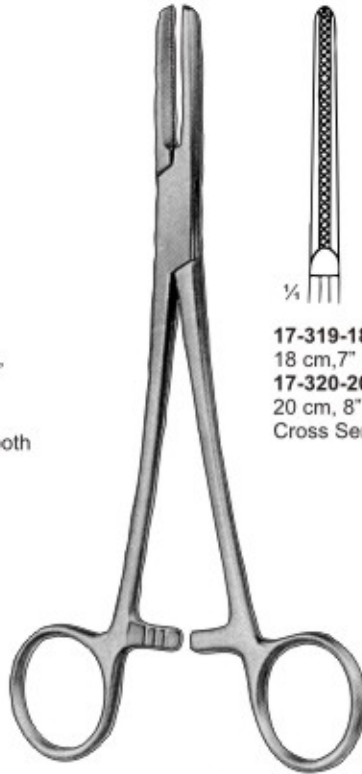

17-319-180  
18 cm, 7"  
17-320-200  
20 cm, 8"  
Cross Serrated

TUBING

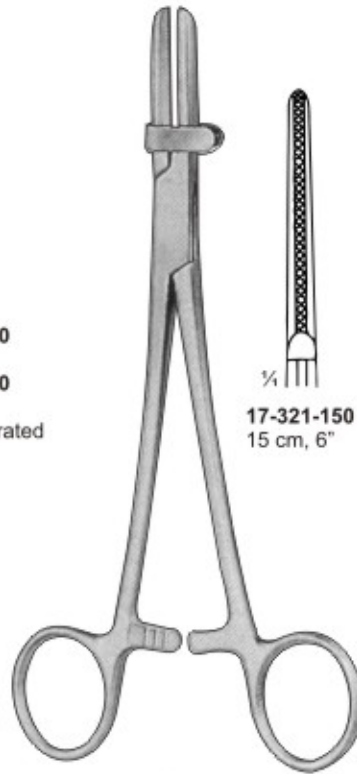

17-321-150  
15 cm, 6"  
17-322-180  
18 cm, 7"  
17-323-200  
20 cm, 8"

TUBING CLUMP  
with Protector,  
Cross Serrated



17-324-145  
14.5 cm, 5 3/4"  
with long ratchet

KLINIKUM BERLIN

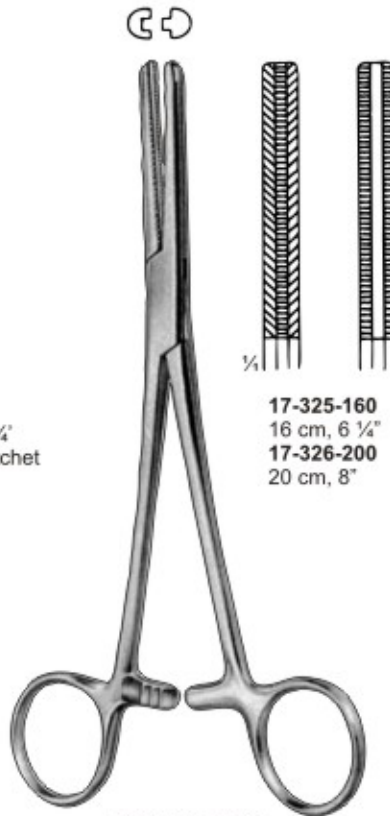

17-325-160  
16 cm, 6 1/4"  
17-326-200  
20 cm, 8"

FERGUSSON

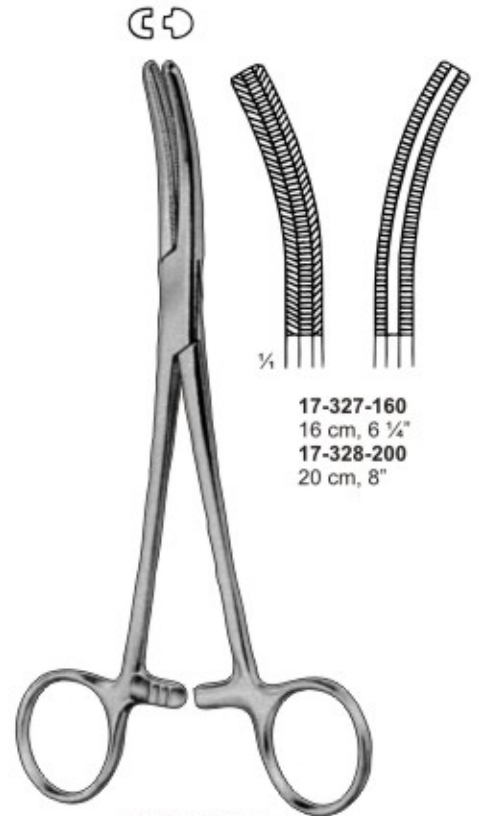

17-327-160  
16 cm, 6 1/4"  
17-328-200  
20 cm, 8"

FERGUSSON



# HAEMOSTATIC FORCEPS

Arterienklemmen  
Pinzas hemostaticas

Pinces hemostatiques  
Pinze emostatiche

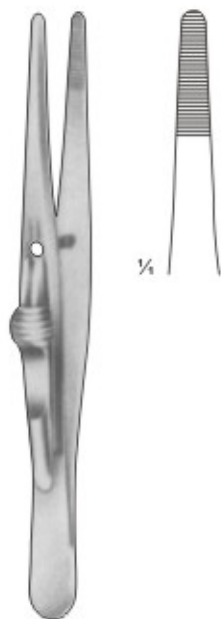

**FRICKE**  
Artery Forceps  
17-329-130  
13cm, 5 1/4"

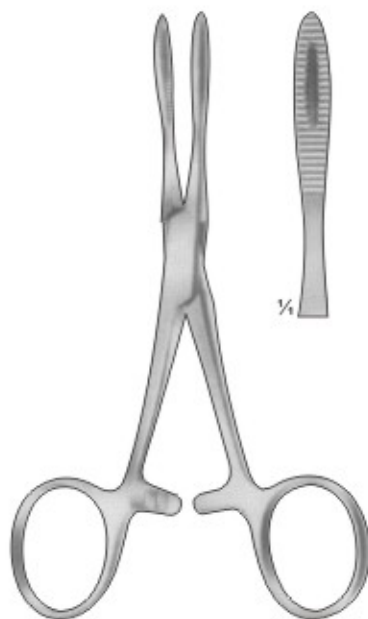

**KRONLEIN**  
17-330-130  
13cm, 5 1/4"

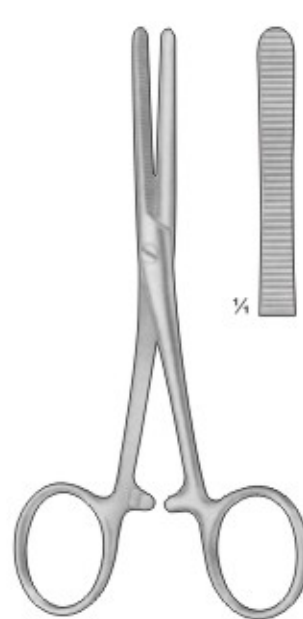

**PEAN**  
17-331-125  
12.5cm, 4 3/4"

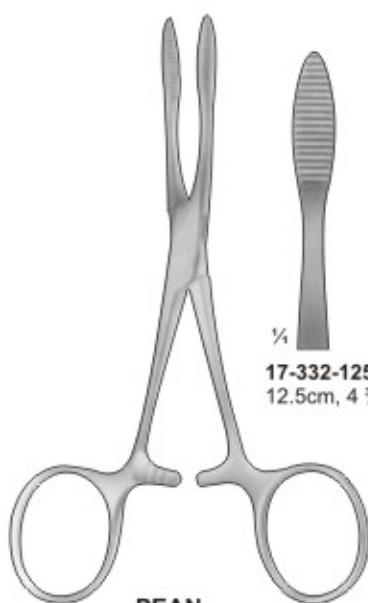

**17-332-125**  
12.5cm, 4 3/4"

**PEAN**



**17-333-140**  
14cm, 5 1/2"

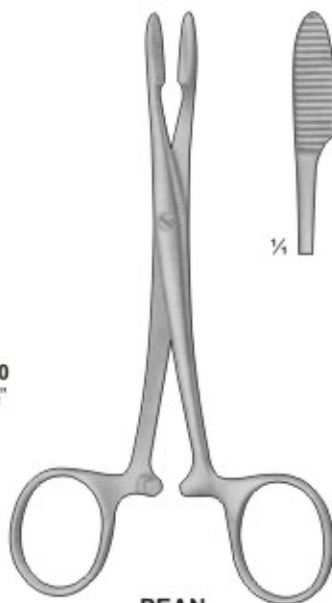

**PEAN**  
17-334-125

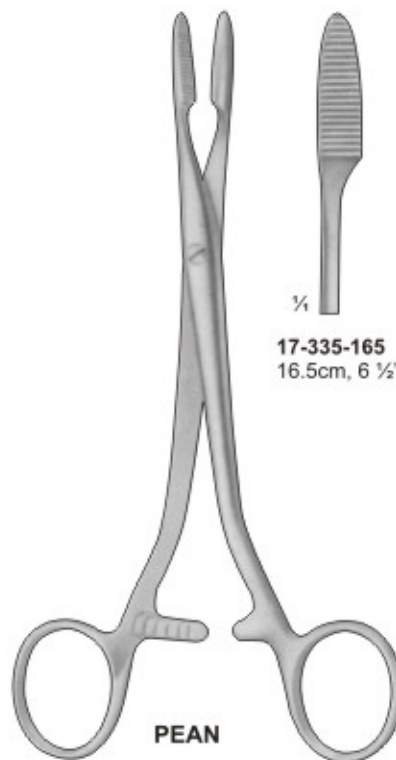

**17-335-165**  
16.5cm, 6 1/2"

**PEAN**



**17-336-185**  
18.5cm, 7 1/4"

## SPONGE & DRESSING FORCEPS



Anatomische pinzetten, Schwammzange  
Pinzas de disección, Pinza para tapones

Marteaux-percuteurs, Pince pour éponges  
Pinze per dissezione, Pinza per tamponi e sponge

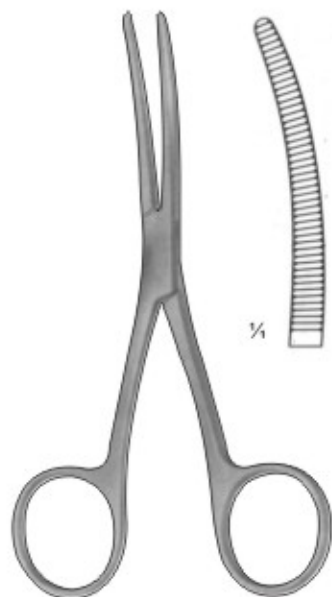

**BRYANT**  
17-337-130  
13cm, 5 1/4"

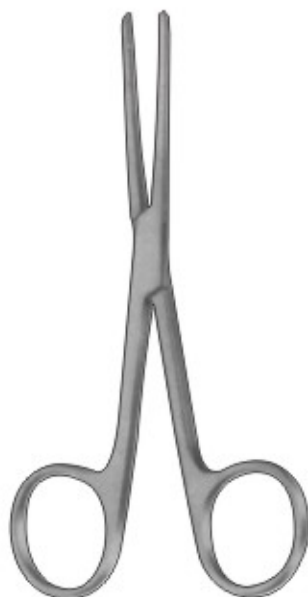

**LISTER**  
Sinus Forceps

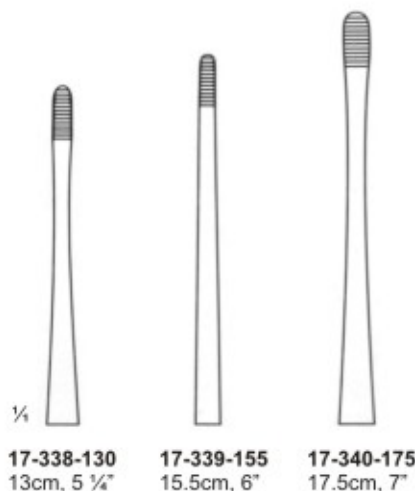

17-338-130  
13cm, 5 1/4"

17-339-155  
15.5cm, 6"

17-340-175  
17.5cm, 7"

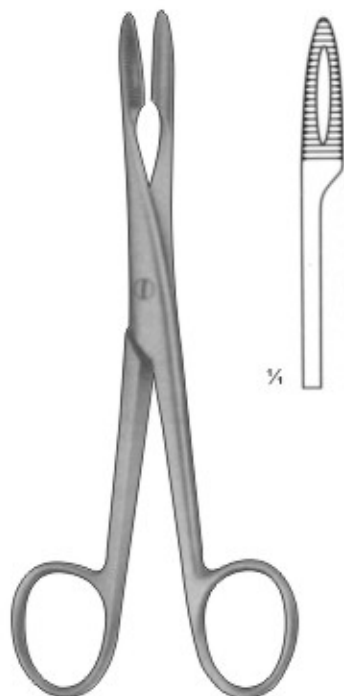

With Ratchet  
17-341-145  
14.5cm, 5 3/4"

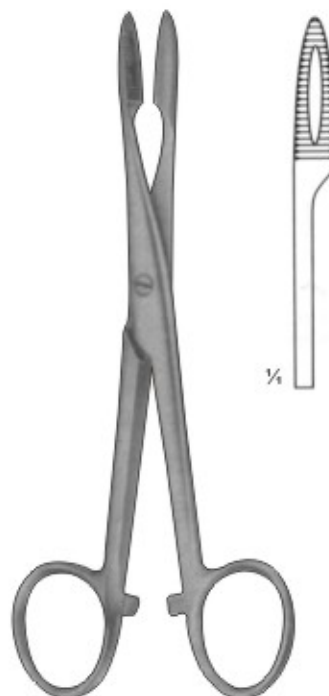

With Ratchet  
17-342-145  
14.5cm, 5 3/4"



## SPONGE & DRESSING FORCEPS

Anatomische pinzetten, Schwammzange  
Pinzas de disección, Pinza para tapones

Marteaux-percuteurs, Pince pour éponges  
Pinze per dissezione, Pinza per tamponi e spunge

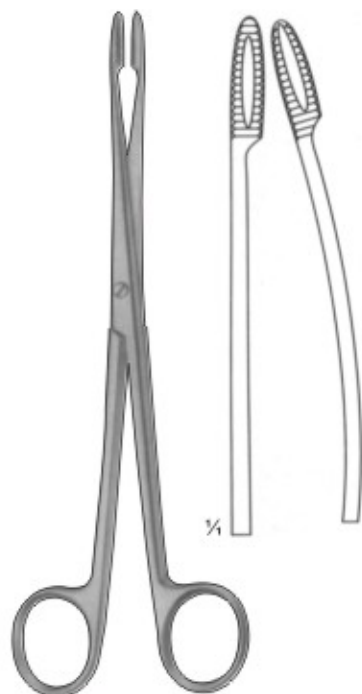

**GROSS**  
With Ratchet  
17-343-200  
20cm, 8"

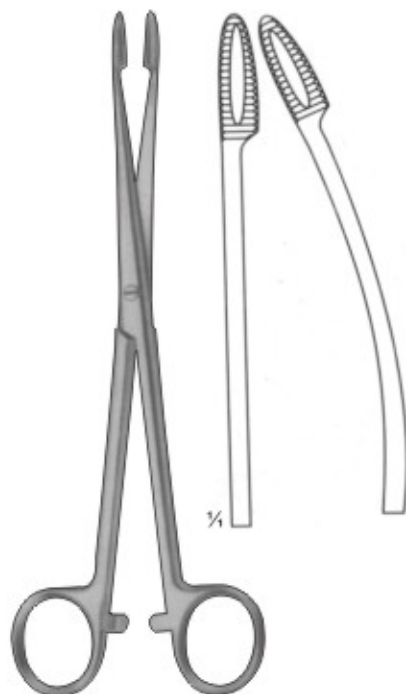

**GROSS**  
With Ratchet  
17-344-180  
18cm, 7"

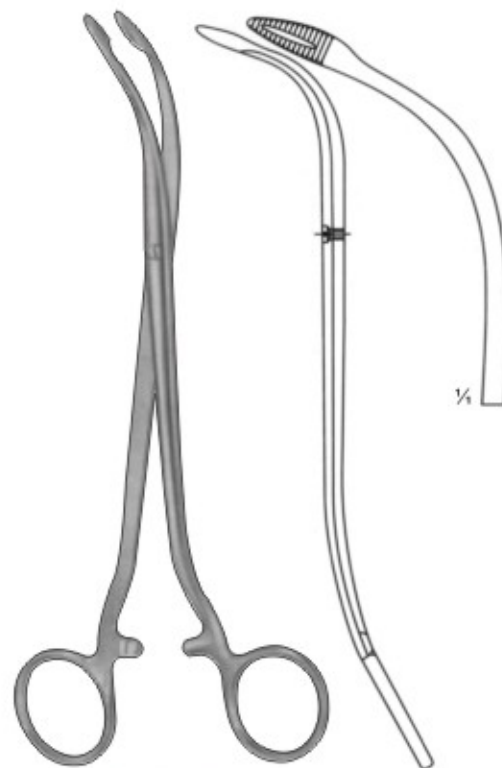

**DUPLAY**  
17-345-190  
19cm, 7 1/2"

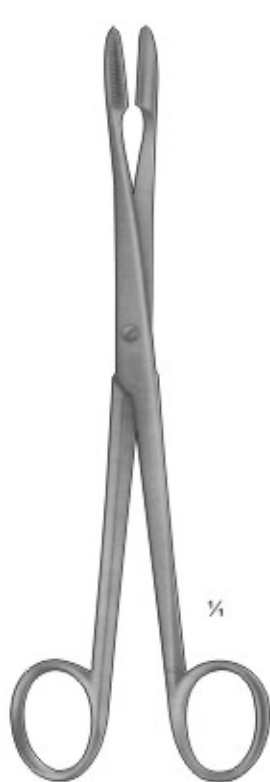

**GROSS**  
Without Ratchet  
17-346-200  
20cm, 8"

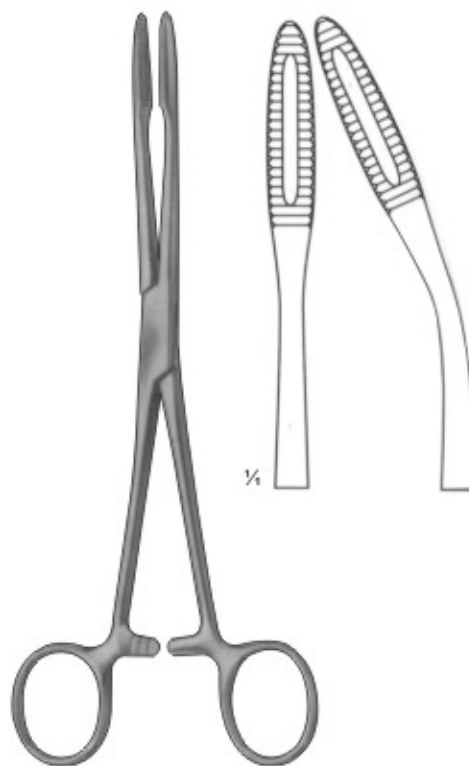
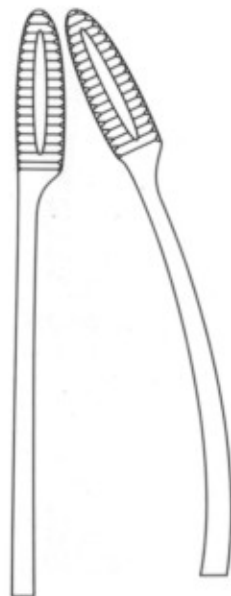

**GROSS**  
With Ratchet  
17-347-200  
20cm, 8"

# HAEMOSTATIC FORCEPS



Arterienklemmen  
Pinzas hemostaticas

Pinces hemostatiques  
Pinze emostatiche



**TUFFIER**  
17-348-130  
13.0 cm, 5"

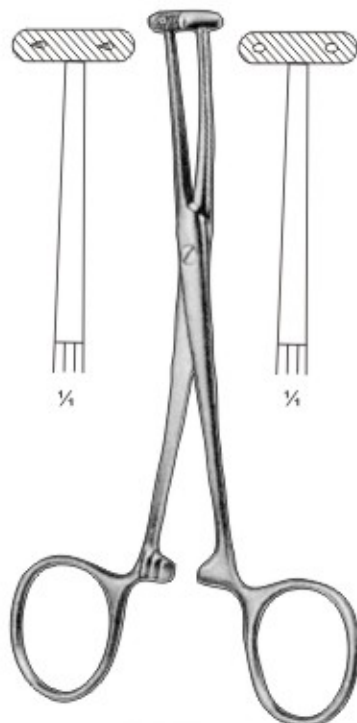

**MARTEL**  
17-349-140  
14.0 cm, 5 1/2"

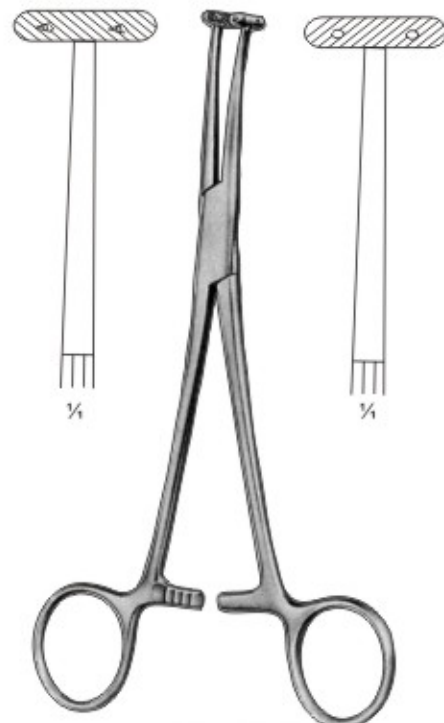

**WILLET-MARTEL**  
17-350-190  
19.0 cm, 7 1/2"

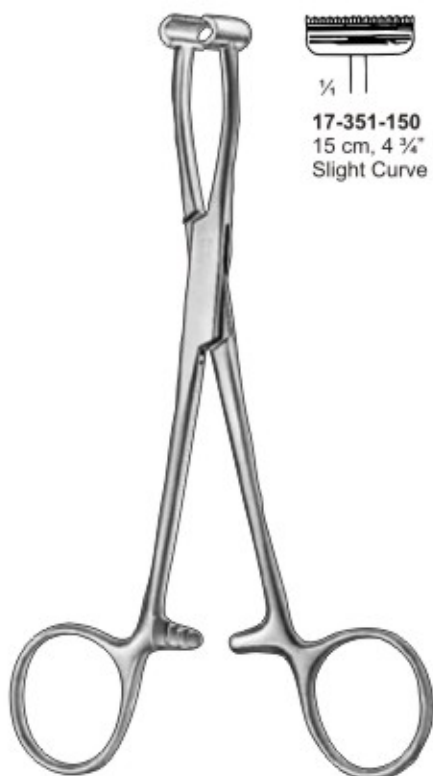

**17-351-150**  
15 cm, 4 3/4"  
Slight Curve

**PRATT**

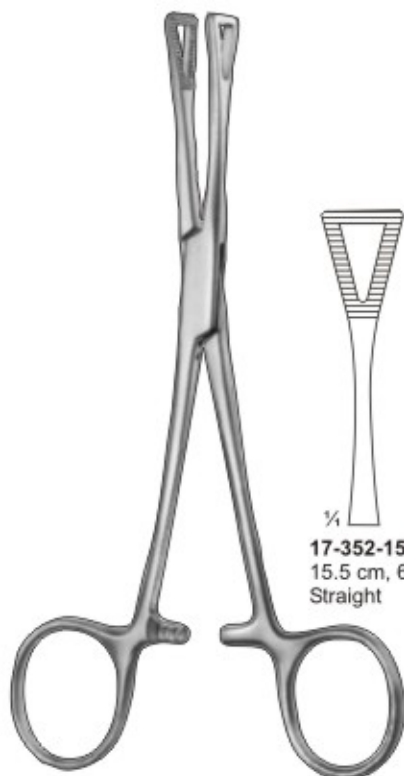

**17-352-155**  
15.5 cm, 6"  
Straight

**PENNINGTON / SIEZING**



**17-353-200**  
20 cm, 8"  
Straight



**CHAPUT**  
17-354-130  
13.0 cm, 5"





## SPONGE & DRESSING FORCEPS

Anatomische pinzetten, Schwammzange  
Pinzas de disección, Pinza para tapones

Marteaux-percuteurs, Pince pour éponges  
Pinze per dissezione, Pinza per tamponi e sponge

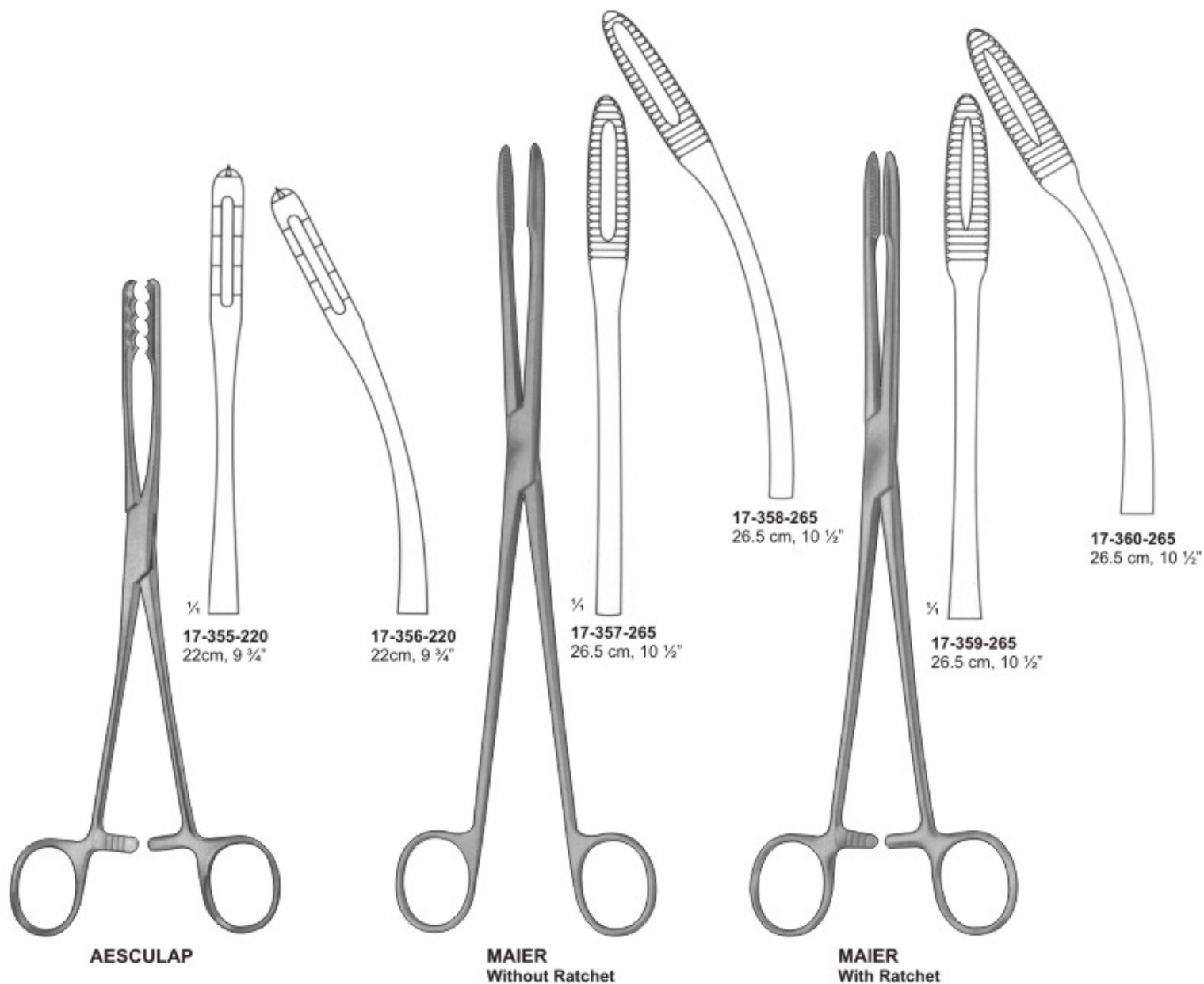

# SPONGE & DRESSING FORCEPS



Anatomische pinzetten, Schwammzange  
Pinzas de disección, Pinza para tapones

Marteaux-percuteurs, Pince pour éponges  
Pinze per dissezione, Pinza per tamponi e sponge

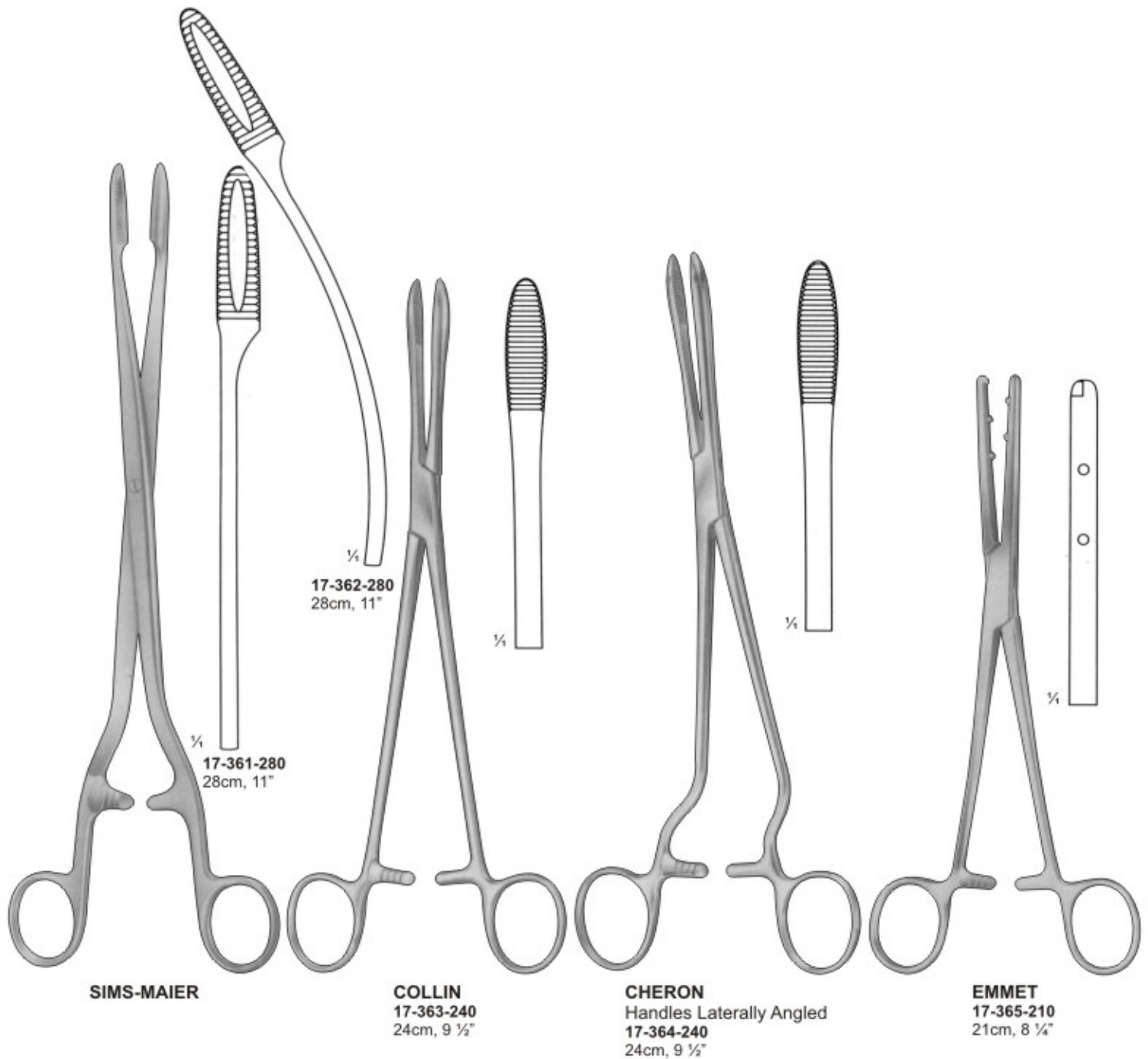



## TENDON SEIZING FORCEPS

Perkussionshämmer  
Martillos de percusion

Marteaux-percuteurs  
Martelli percussori

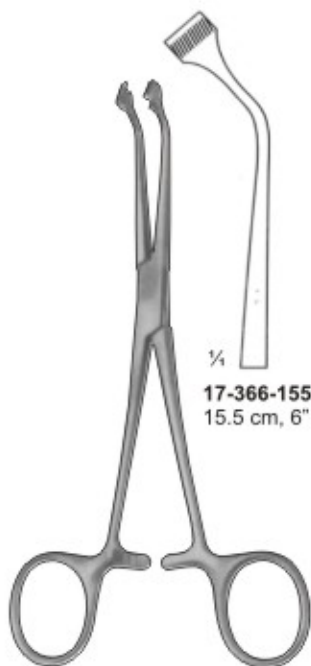

17-366-155  
15.5 cm, 6"

HERZ



17-367-155  
15.5 cm, 6"

JACKSON

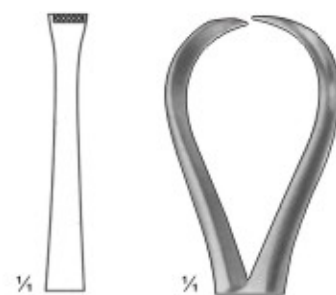

17-368-150  
4 x 5 teeth  
15 cm, 6"

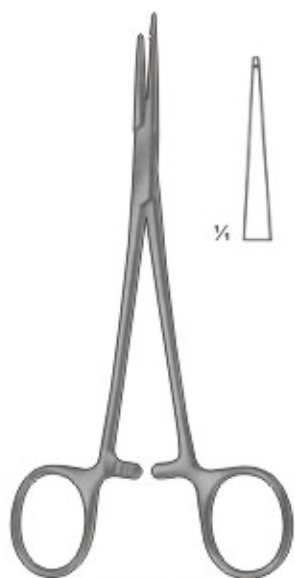

17-369-150  
15cm, 6"

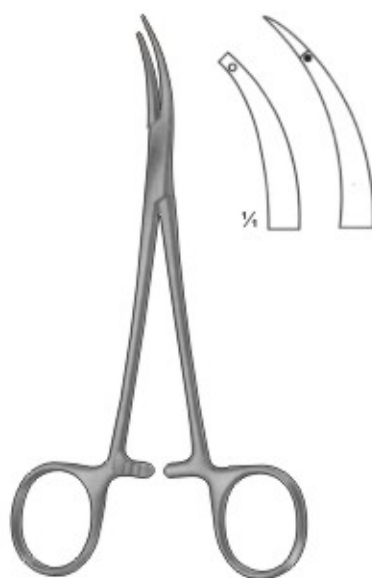

17-370-150  
15cm, 6"

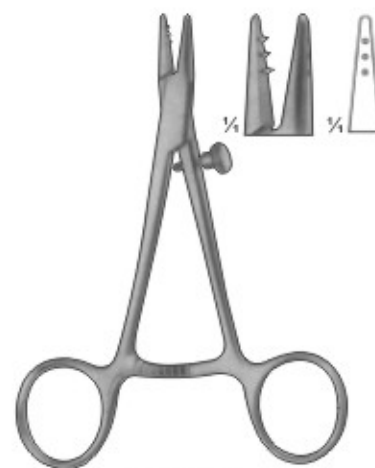

17-371-120  
12cm, 5"

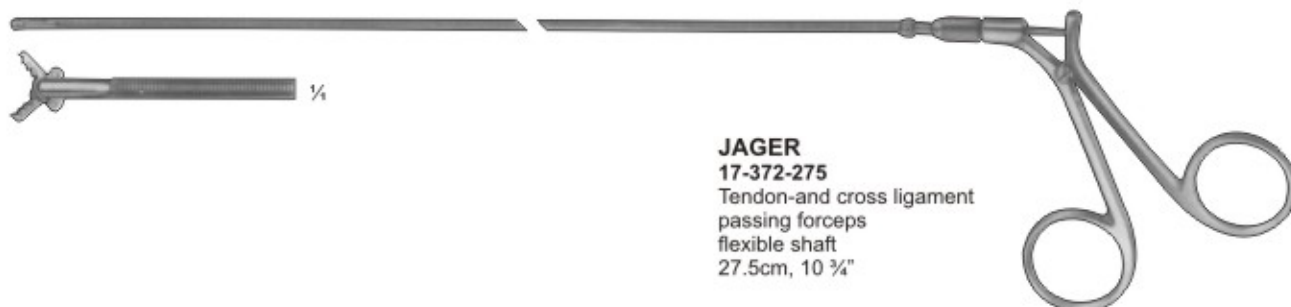

JAGER  
17-372-275  
Tendon and cross ligament  
passing forceps  
flexible shaft  
27.5cm, 10 3/4"

# SPONGE FORCEPS



Schwammzange  
Pinza para tapones

Pince pour éponges  
Pinza per tamponi e sponge

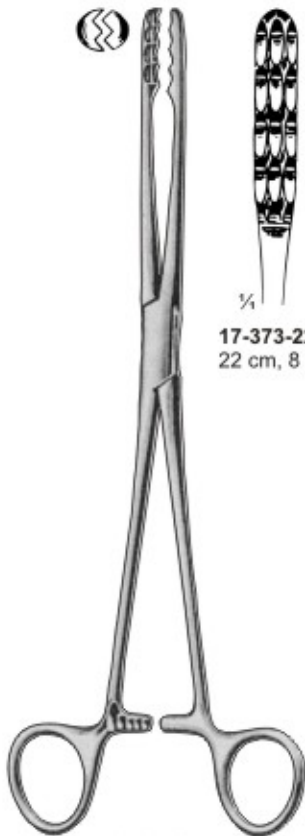

17-373-220  
22 cm, 8 3/4"

ULRICH

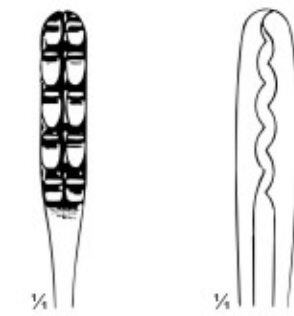

17-374-250  
25 cm, 10"  
17-375-270  
27 cm, 11"



17-376-220  
22 cm, 8 3/4"

ULRICH



17-377-250  
25 cm, 10"  
17-378-270  
27 cm, 11"



HEYWOOD SMITH  
17-379-250  
25 cm, 10"



17-380-240  
24 cm, 9 1/2"

FLETCHER

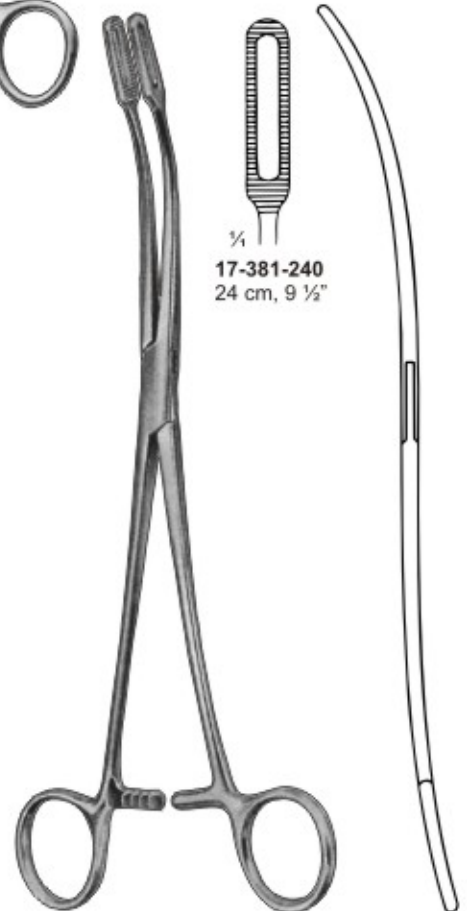

17-381-240  
24 cm, 9 1/2"

FLETCHER



## SPONGE FORCEPS

Schwammzange  
Pinza para tapones

Pince pour éponges  
Pinza per tamponi e sponge



17-382-250  
25 cm, 10"

PELKMANN



17-383-250  
25 cm, 10"

PELKMANN



17-384-205  
20.5 cm, 8"

DUPLAY

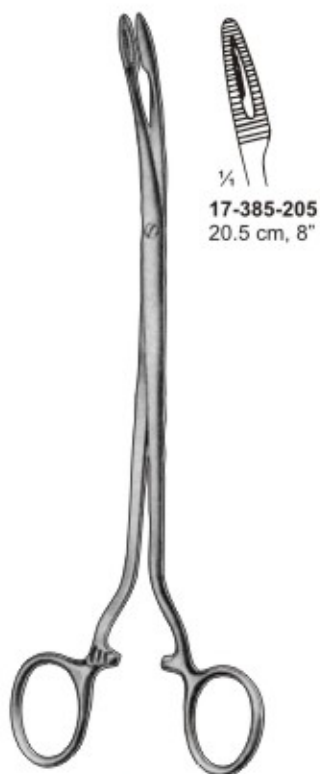

17-385-205  
20.5 cm, 8"

DUPLAY

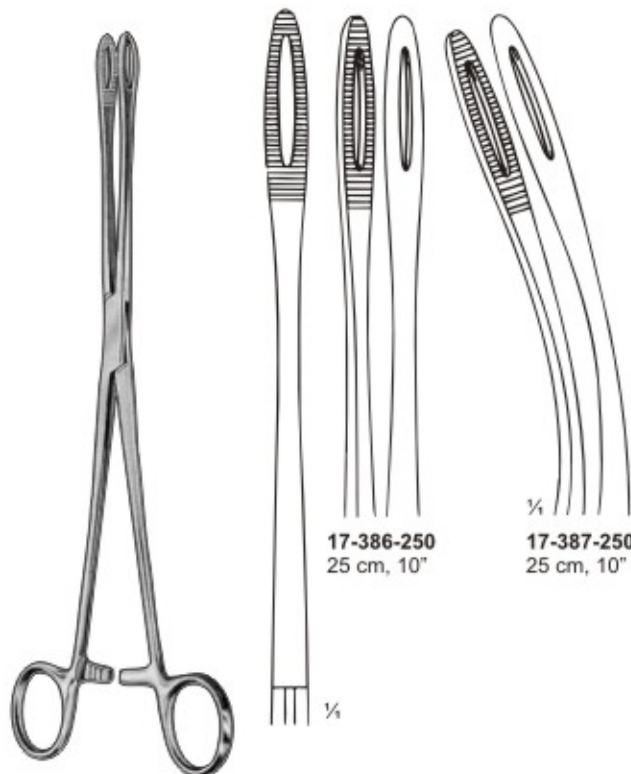

17-386-250  
25 cm, 10"

17-387-250  
25 cm, 10"

FOERSTER-BALLENGER

# SPONGE FORCEPS



Schwammzange  
Pinza para tapones

Pince pour éponges  
Pinza per tamponi e sponge

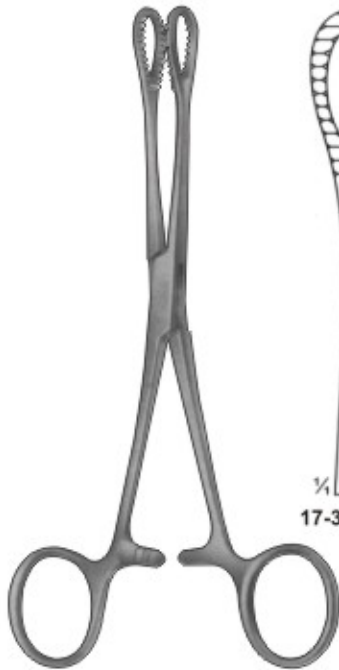

**FOERSTER-BALLENGER**  
17-388-180  
18cm, 7"



17-389-180



17-390-180

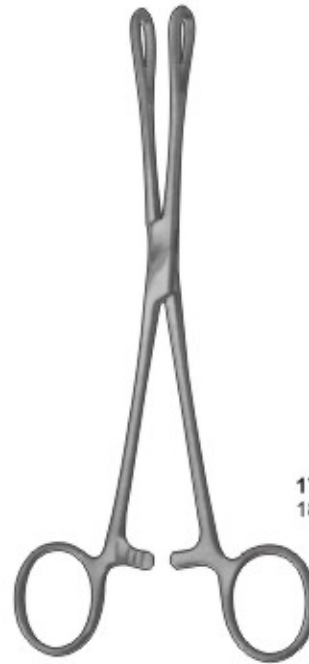

**RAMPLEY**  
17-391-180



17-392-180  
18cm, 7"



17-393-250  
25cm, 10"



**FOERSTER**



1/4



1/4



1/4

17-394-25  
25.0cm 10"  
Round



1/4

17-395-18  
18.0cm 7"  
17-396-20  
20.0cm 8"  
17-397-25  
25.0cm 10"  
Round



1/4

17-398-25  
25.0cm 10"  
Round



1/4

17-399-18  
18.0cm 7"  
17-400-20  
20.0cm 8"  
17-401-25  
25.0cm 10"  
Round



## SPONGE & DRESSING FORCEPS

Anatomische pinzetten, Schwammzange  
Pinzas de disección, Pinza para taponos

Marteaux-percuteurs, Pince pour éponges  
Pinze per dissezione, Pinza per tamponi e spunge

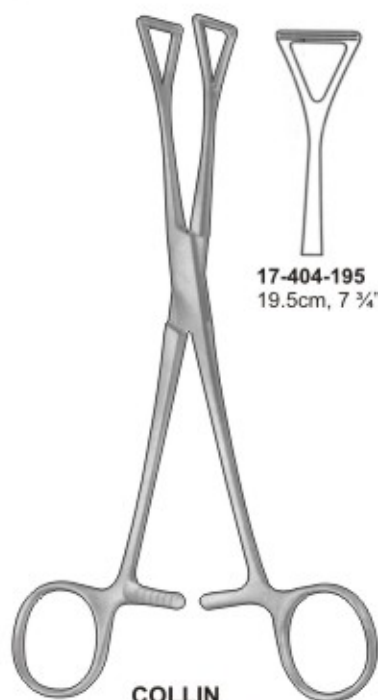

**COLLIN**  
17-403-195



**17-404-195**  
19.5cm, 7 3/4"

**17-405-230**  
23cm, 9"

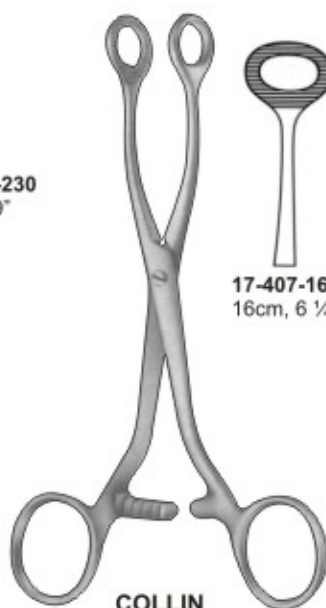

**COLLIN**  
17-406-160

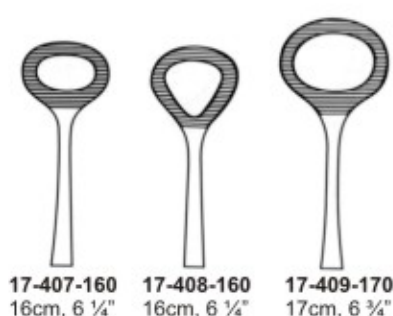

**17-407-160**  
16cm, 6 1/4"

**17-408-160**  
16cm, 6 1/4"

**17-409-170**  
17cm, 6 3/4"

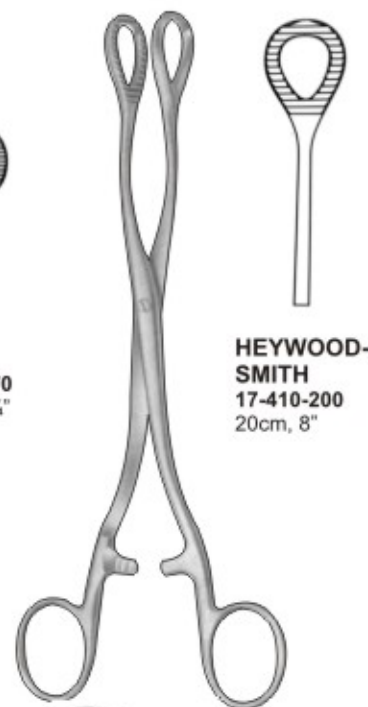

**HEYWOOD-SMITH**  
17-410-200  
20cm, 8"

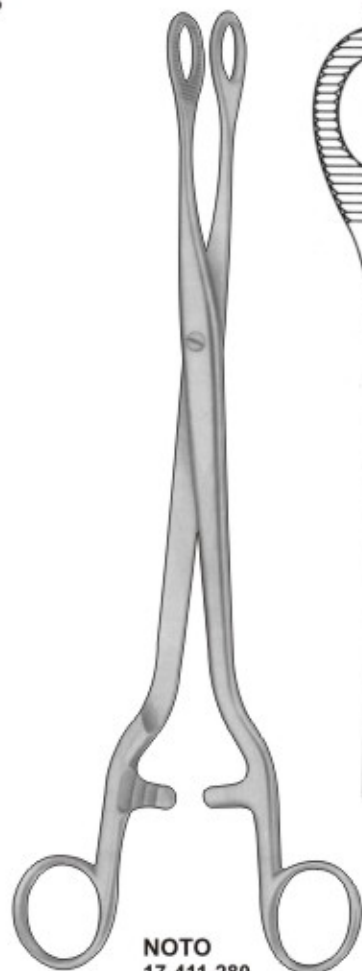

**NOTO**  
17-411-280  
28cm, 11"

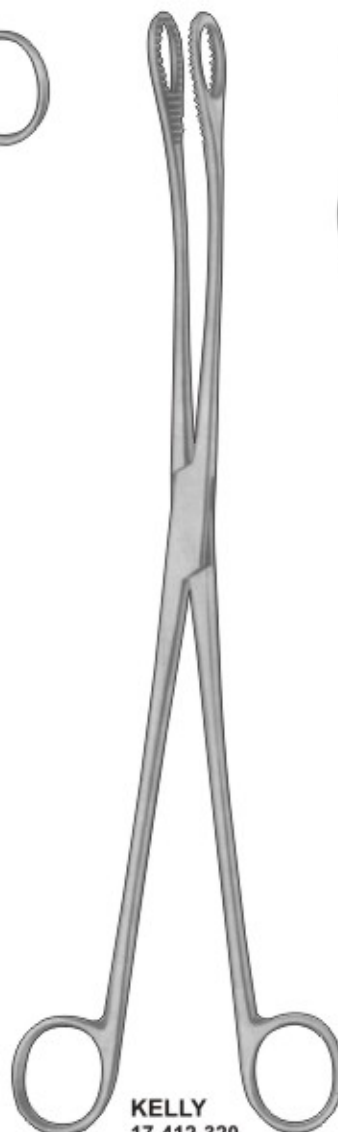
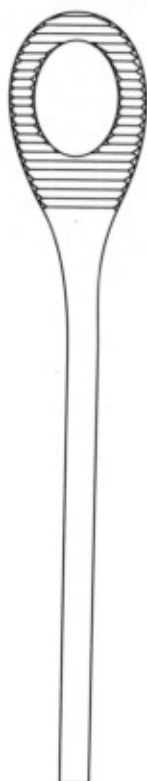

**KELLY**  
17-412-320  
32cm, 12 1/2"

# NEEDLE HOLDERS



- **NEEDLE HOLDERS**
- **REVERDIN NEEDLES**

- **SUTURE INSTRUMENTS**
- **GENERAL INSTRUMENTS**

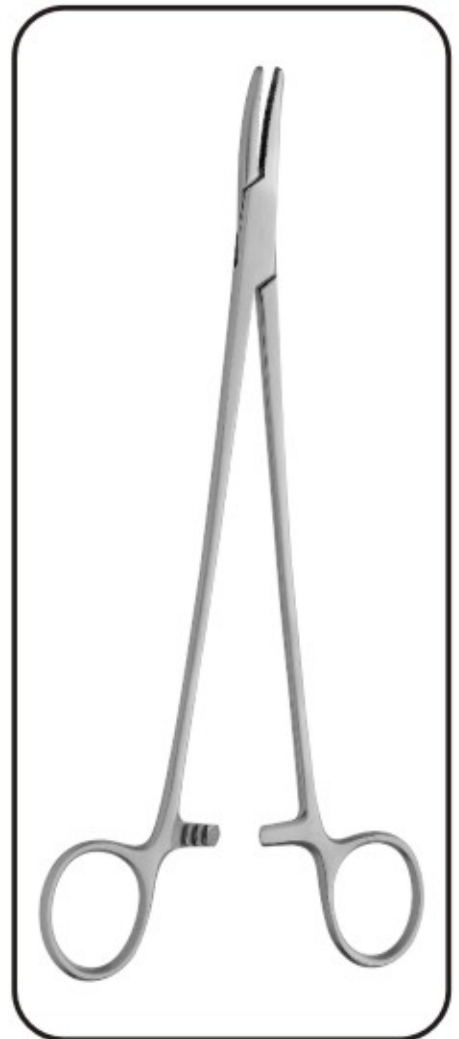





# NEEDLE HOLDERS

Nadelhalter  
Porta-agujas

Porte-agujas  
Portaghi



MAYO-HEGAR



18-001-140  
14 cm, 5 1/2"  
Serrated-Grooved



18-002-160  
16 cm, 6 1/4"  
Serrated-Grooved



18-003-180  
18 cm, 7"  
Serrated-Grooved



18-004-200  
20 cm, 8"  
Serrated-Grooved



18-005-240  
24 cm, 9 3/4"  
Serrated-Grooved



18-006-260  
26 cm, 10 1/4"  
Serrated-Grooved



18-007-305  
30.5 cm, 12"  
Serrated-Grooved



18-008-140  
14 cm, 5 1/2"  
Serrated-Grooved Curved



18-009-160  
16 cm, 6 1/4"  
Serrated-Grooved Curved



18-010-180  
18 cm, 7"  
Serrated-Grooved Curved



18-011-200  
20 cm, 8"  
Serrated-Grooved Curved



18-012-240  
24 cm, 9 3/4"  
Serrated-Grooved Curved



18-013-260  
26 cm, 10 1/4"  
Serrated-Grooved Curved



18-014-305  
30.5 cm, 12"  
Serrated-Grooved Curved



BAUMGARTNER



18-015-140  
14 cm, 5 1/2"  
Serrated-Solid

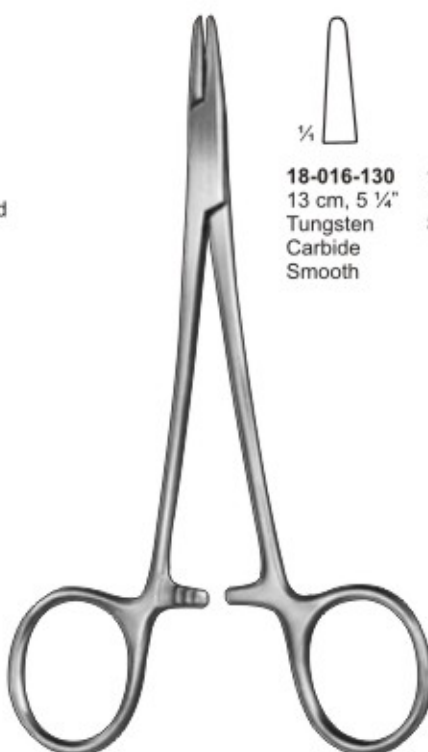

WEBSTER



18-016-130  
13 cm, 5 1/4"  
Tungsten Carbide Smooth



18-017-130  
13 cm, 5 1/4"  
Smooth



BROWN



18-018-130  
13 cm, 5 1/4"  
Serrated-Solid



18-019-190  
19 cm, 7 1/2"  
Serrated-Solid

# NEEDLE HOLDERS



Nadelhalter  
Porta-agujas

Porte-agujas  
Portaghi



**18-020-180**  
18 cm, 7"



**18-021-260**  
26 cm, 10 1/4"

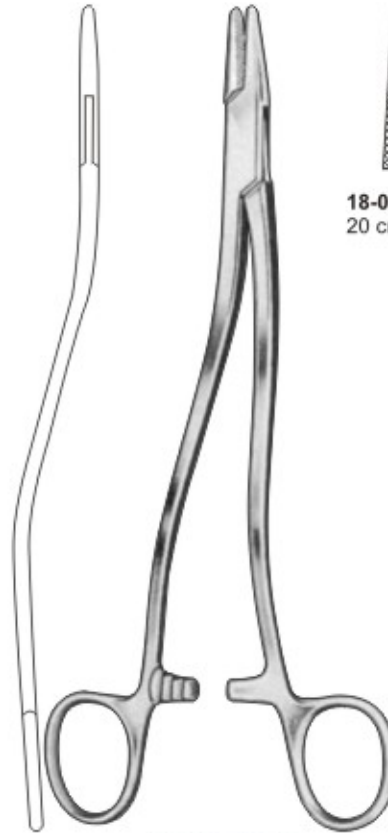

**18-022-200**  
20 cm, 8"

**18-023-240**  
24 cm, 9 1/2"

**18-024-260**  
26 cm, 10 1/4"

**SAROT**

**BOZEMANN**



**BABY CRILE-WOOD**  
18-025-150 15 cm, 6"



**CRILE-WOOD**

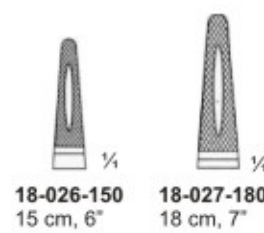

**18-026-150**  
15 cm, 6"

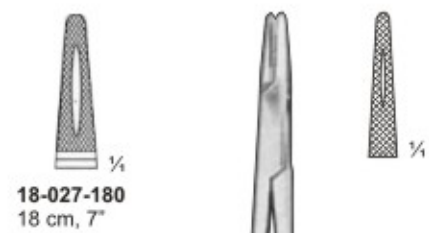

**18-027-180**  
18 cm, 7"

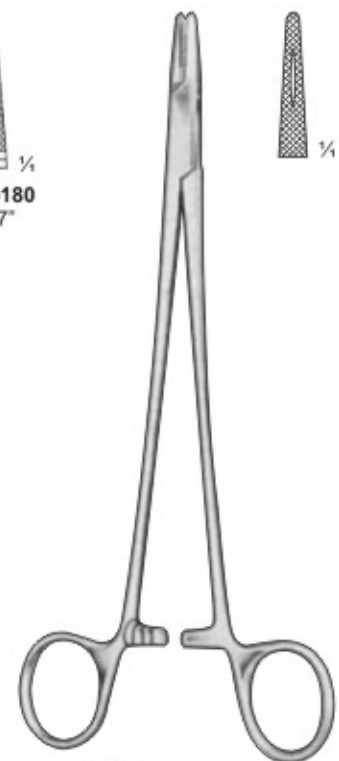

**CARROLL**  
18-028-150 15 cm, 6"



# NEEDLE HOLDERS

Nadelhalter  
Porta-agujas

Porte-agujas  
Portaghi



**JAMESON**  
18-029-230  
23.5 cm, 9 1/4"



**FINOCCHIETTO**  
18-030-270  
27 cm, 10 3/4"

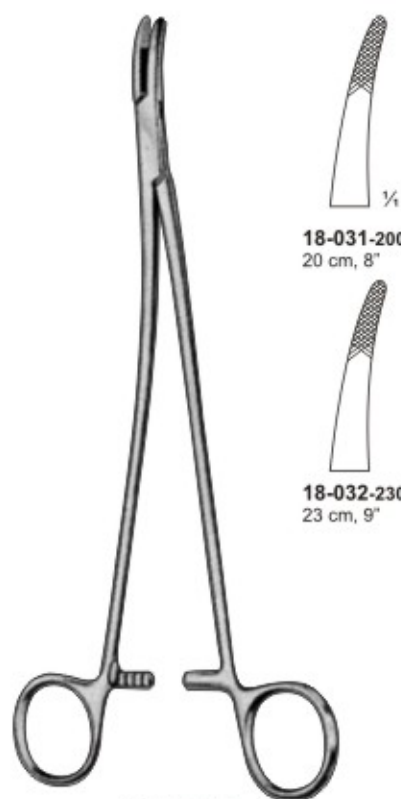

**18-031-200**  
20 cm, 8"

**18-032-230**  
23 cm, 9"

**STRATTE**

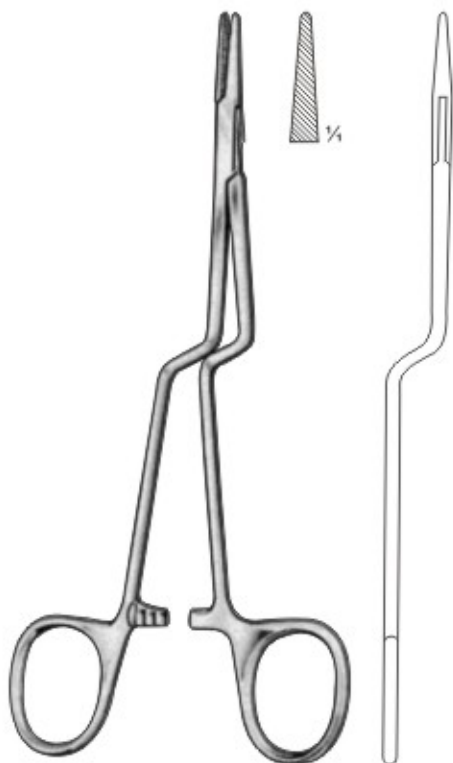

**JACOBSON**  
18-033-180  
18 cm, 7"

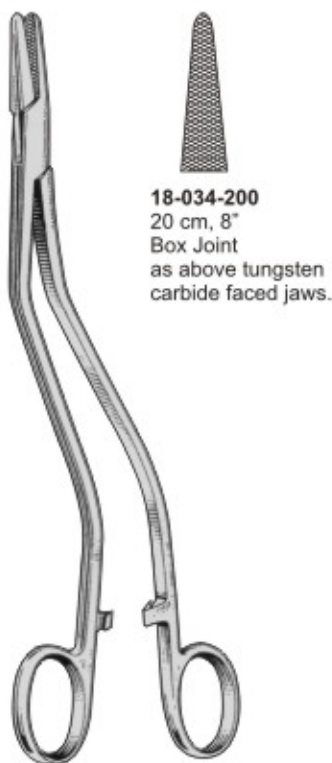

**18-034-200**  
20 cm, 8"  
Box Joint  
as above tungsten  
carbide faced jaws.

**THOMSON WALKER**

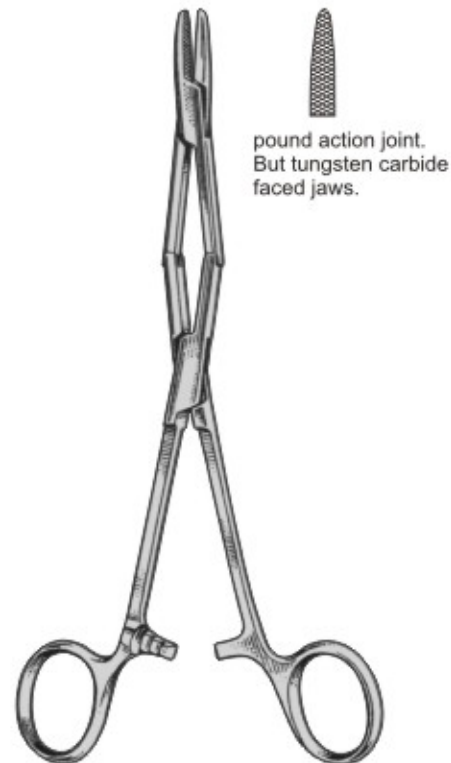

pound action joint.  
But tungsten carbide  
faced jaws.

**NAUNTUN MORGAN**  
18-035-180 18 cm, 7"  
18-036-250 25 cm, 10"

# NEEDLE HOLDERS



Nadelhalter  
Porta-agujas

Porte-agujas  
Portaghi



**M.G.H.**  
(Mass. General Hospital)  
**18-037-170**  
17 cm, 6 3/4"



**ADSON**  
**18-038-180**  
18 cm, 7"



**HEANEY**  
**18-039-210**  
21 cm, 8 1/4"



**18-040-130**   **18-041-180**  
13 cm, 5 1/4"   18 cm, 7"

**BROWN**

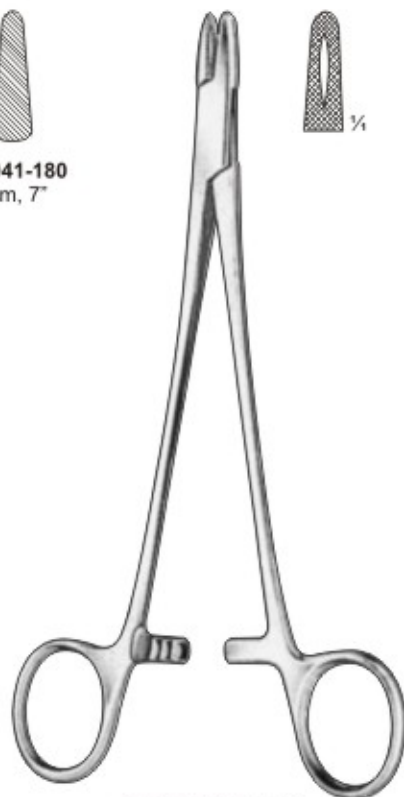

**NEW ORLEANS**  
**18-042-180**  
18 cm, 7"



**18-043-150**  
15 cm, 6"

**18-044-170**  
17 cm, 6 3/4"

**SENNING**  
(Schwed. Model)



# NEEDLE HOLDERS

Nadelhalter  
Porta-agujas

Porte-agujas  
Portaghi



**WERTHEIM**  
18-045-200 20 cm, 8"  
18-046-240 24 cm, 9 1/2"

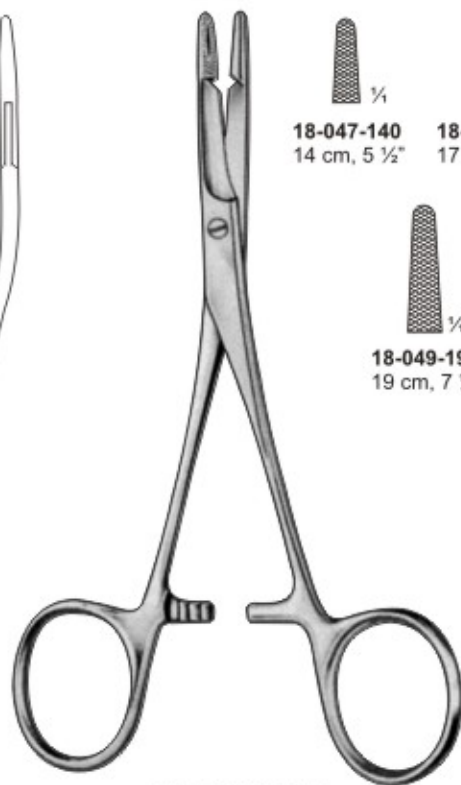

**OLSEN-HEGAR**

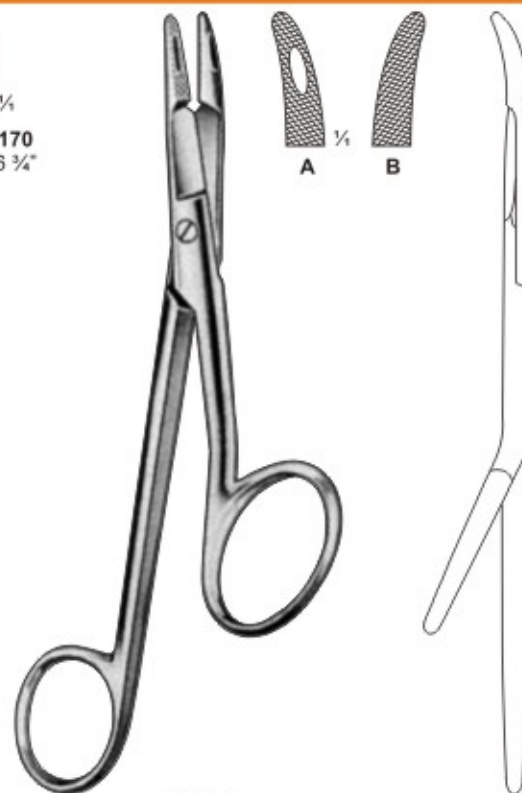
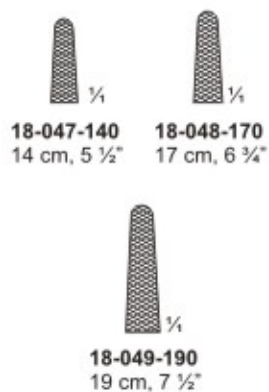

**GILLIES**  
18-050-160  
16 cm, 6 1/4"



**MASSON**  
18-051-270  
27 cm, 10 3/4"

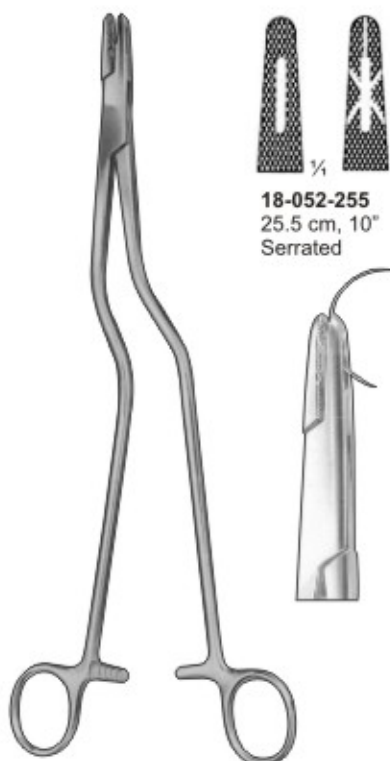

**MASSON-LUETHY**

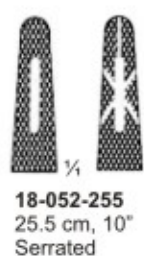

**WANGENSTEEN**  
18-053-270  
27 cm, 10 3/4"

# NEEDLE HOLDERS



Nadelhalter  
Porta-agujas

Porte-agujas  
Portaghi

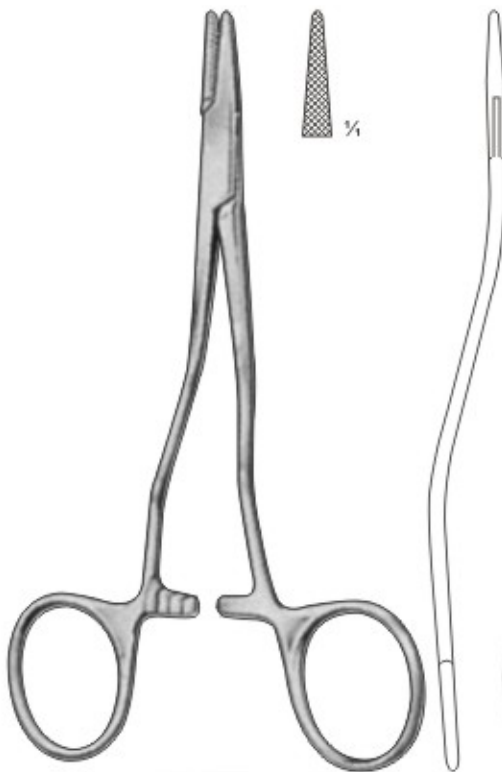

**KILNER**  
18-054-130  
13 cm, 5 1/2"



**HALSEY**

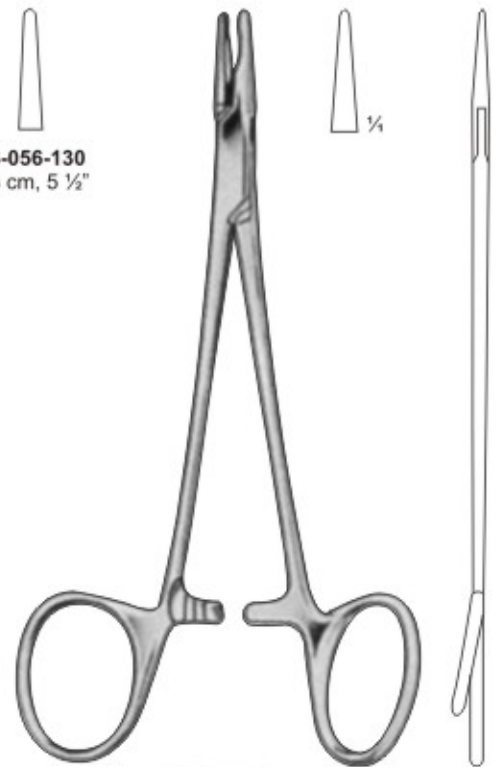

**NEIVERT**  
18-057-130  
13 cm, 5 1/2"

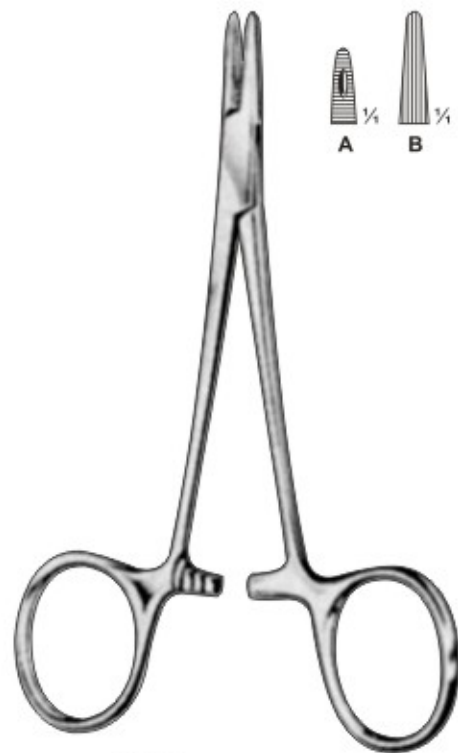

**DERF**  
18-058-120 12 cm, 5" A  
18-059-120 12 cm, 5" B



**COLLIER**  
18-060-125  
12.5 cm, 5"

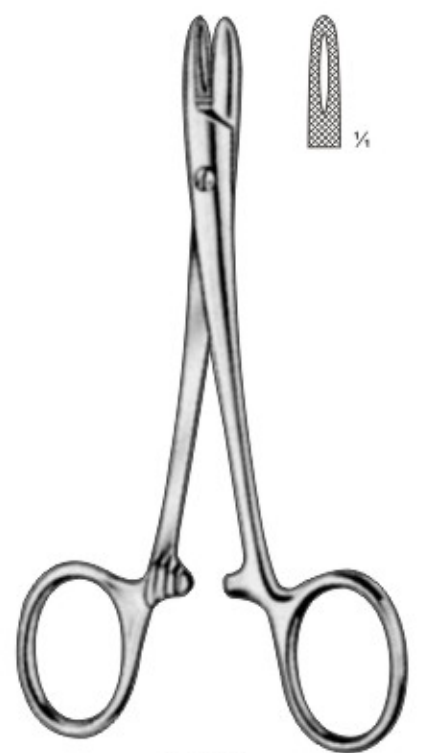

**DOYEN**  
18-061-125  
12.5 cm, 5"



## NEEDLE HOLDERS

Nadelhalter  
Porta-agujas

Porte-agujas  
Portaghi



**HEGAR-BAUMGARTNER**  
18-062-145  
14.5 cm, 5 3/4"



**CRILE-MURRAY**  
18-063-150  
15 cm, 6"



**METZENBAUM**  
18-064-185  
18.5 cm, 7 1/4"

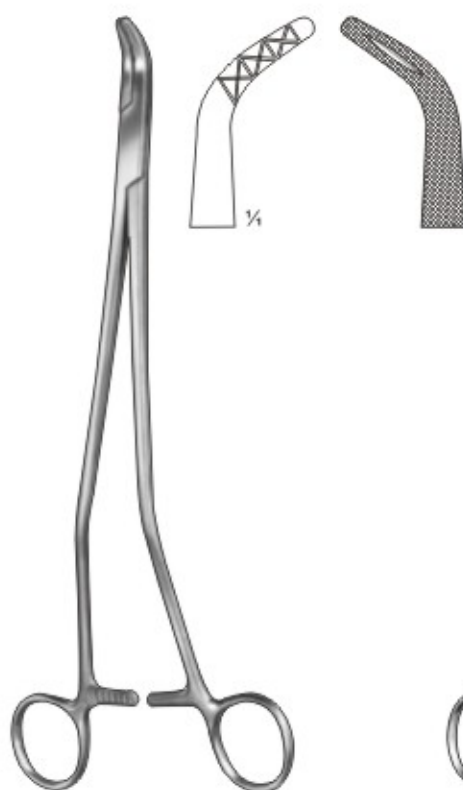

**JOHNSON**  
18-065-270  
27 cm, 10 1/4"



**WANGENSTEEN**  
Serrated-Solid



# NEEDLE HOLDERS



Nadelhalter  
Porta-agujas

Porte-agujas  
Portaghi

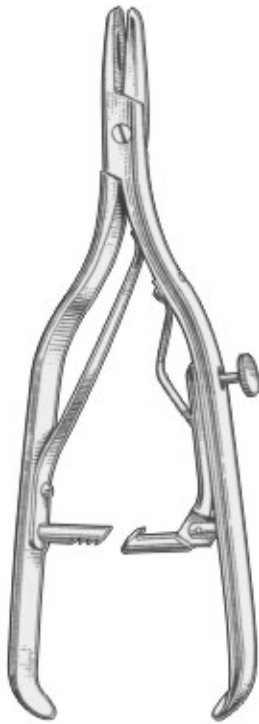

**MAYO ROCHESTER**  
18-068-180 18 cm, 8"  
18-069-230 23 cm, 9"  
button release, screw joint.

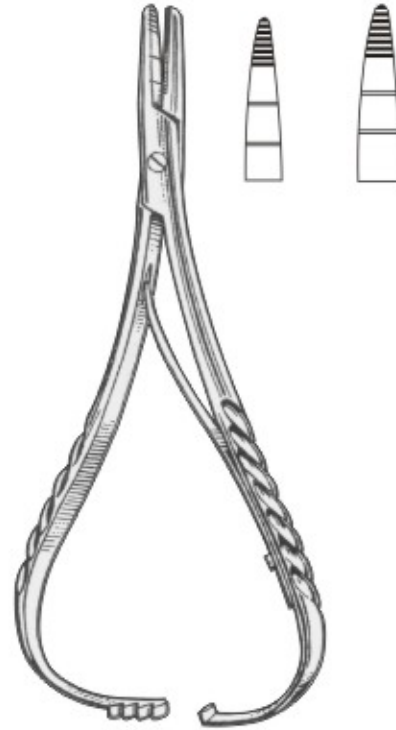

**MACPHAIL**  
18-070-150 15 cm, 6"  
18-071-180 18 cm, 7"  
18-072-200 20 cm, 8"  
lined with copper.



**MATHIEU**

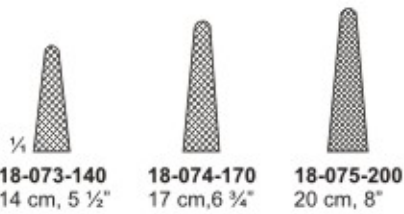

**MATHIEU**

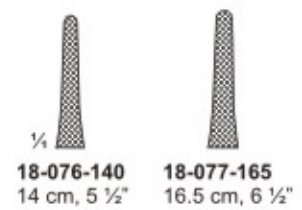





## NEEDLE HOLDERS

Nadelhalter  
Porta-agujas

Porte-agujas  
Portaghi



**TOENNIS**  
18-078-185  
18.5 cm, 7 1/4"



**CRILE**  
18-079-150  
15 cm, 6"



**CASTROVIEJO  
OLSEN HEAGER /  
Needle Holders / Scissors**  
18-080-145 14.5 cm, 5 3/4"  
18-081-150 15.0 cm, 6"



**BOYNTON**  
18-082-120  
12 cm, 5"



**ARRUGA**  
18-083-160 16 cm, 6 1/4" Str.  
18-084-160 16 cm, 6 1/4" Cvd.













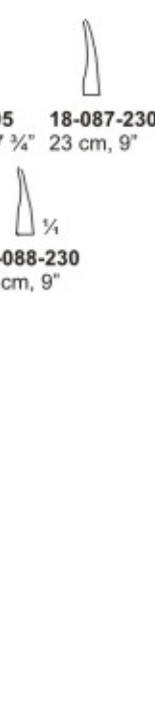







**LICHTENBERG**  
18-085-200 20 cm, 8"

# NEEDLE HOLDERS

Nadelhalter  
Porta-agujas

Porte-agujas  
Portaghi

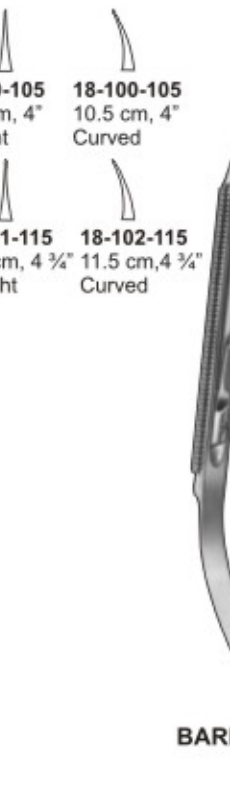

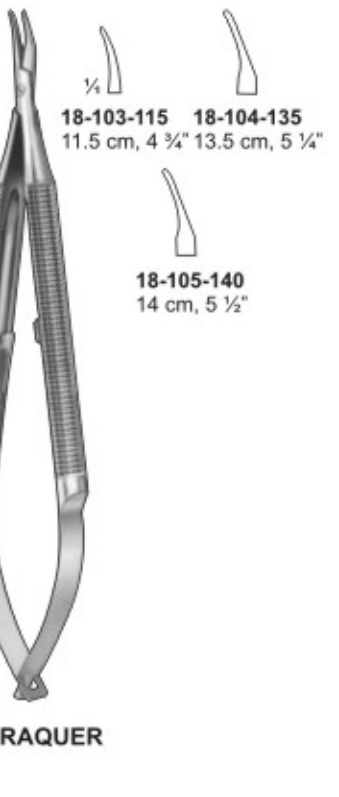
 <p><b>18-086-195</b> 19.5 cm, 7 3/4"</p>  <p><b>18-087-230</b> 23 cm, 9"</p>  <p><b>18-088-230</b> 23 cm, 9"</p>	 <p><b>18-089-160</b> 16 cm, 6 1/4"</p>	 <p><b>18-090-120</b> 12 cm, 5"</p>	 <p><b>18-091-120</b> 12 cm, 5"</p>	 <p><b>18-092-140</b> 14 cm, 5 1/2" Curved, Smooth</p>	 <p><b>18-093-140</b> 14 cm, 5 1/2" Curved, Smooth</p>
<p><b>MICRO</b></p>  <p><b>18-094-135</b> 13.5 cm, 5 1/4"</p>  <p><b>18-095-100</b> 10 cm, 4" Straight</p>  <p><b>18-096-105</b> 10.5 cm, 4" Curved</p> <p><b>BARRAQUER-TROUTMAN</b></p>	<p><b>MICRO</b></p>  <p><b>18-097-135</b> 13.5 cm, 5 1/4" Straight</p>  <p><b>18-098-135</b> 13.5 cm, 5 1/4" Curved</p> <p><b>ARRUGA</b></p>	<p><b>CASTROVIEJO</b></p>  <p><b>18-099-105</b> 10.5 cm, 4" Straight</p>  <p><b>18-100-105</b> 10.5 cm, 4" Curved</p> <p><b>BARRAQUER-TROUTMAN</b></p>	<p><b>CASTROVIEJO</b></p>  <p><b>18-101-115</b> 11.5 cm, 4 3/4" Straight</p>  <p><b>18-102-115</b> 11.5 cm, 4 3/4" Curved</p> <p><b>BARRAQUER</b></p>	<p><b>BARRAQUER</b></p>  <p><b>18-103-115</b> 11.5 cm, 4 3/4"</p>  <p><b>18-104-135</b> 13.5 cm, 5 1/4"</p> <p><b>BARRAQUER</b></p>	<p><b>BARRAQUER/WITH CATCH</b></p>  <p><b>18-105-140</b> 14 cm, 5 1/2"</p>



## NEEDLE HOLDERS T.C. INSERTED

Nadelhalter  
Porta-agujas

Porte-agujas  
Portaghi



### MICROVASCULAR

18-106-180 18 cm, 7"  
18-107-200 20 cm, 8"  
18-108-220 22 cm, 8 3/4"  
18-109-250 25 cm, 10"

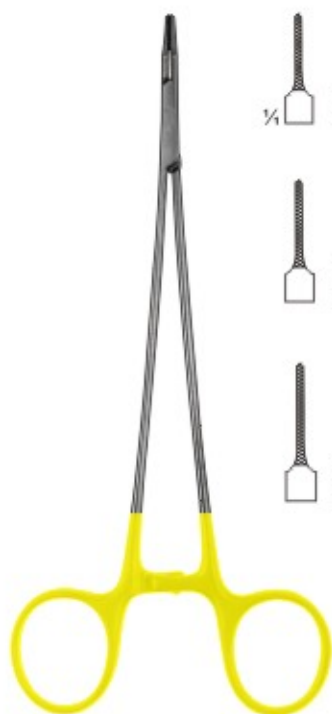

### MICRO RYDER

18-110-150  
15 cm, 6"

18-111-175  
17.5 cm, 7"

18-112-195  
19.5 cm, 7 3/4"



### CRILE-WOOD

18-113-175 17.5 cm, 7"  
18-114-200 20.0 cm, 8"  
18-115-220 22.0 cm, 8 3/4"  
18-116-250 25.0 cm, 10"



### DE BAKEY

18-117-180 18 cm, 7"  
18-118-200 20 cm, 8"  
18-119-220 22 cm, 8 3/4"  
18-120-250 25 cm, 10"



### INTRACARDIAC

18-121-180 18 cm, 7"  
18-122-200 20 cm, 8"  
18-123-220 22 cm, 8 3/4"  
18-124-250 25 cm, 10"



### NEW ORLEANS

18-125-175  
17.5 cm, 7"

# NEEDLE HOLDERS T.C. INSERTED

Nadelhalter  
Porta-agujas

Porte-agujas  
Portaghi



18-126-150  
15 cm, 6"

18-127-170  
17 cm, 6 3/4"

**SENNING**  
(Schwed. Model)

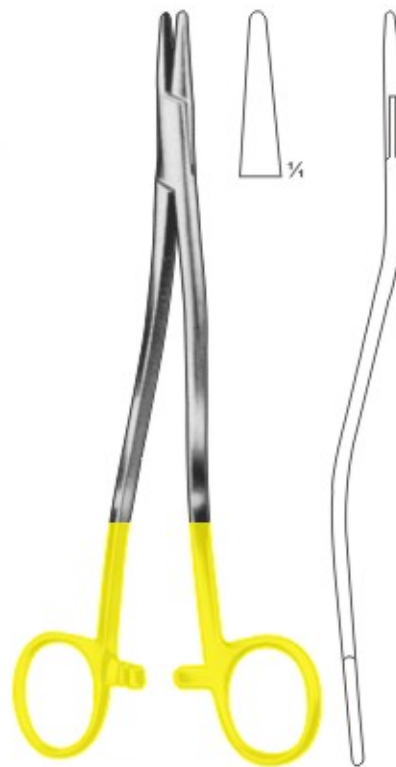

**WERTHEIM**  
18-128-200 20 cm, 8"  
18-129-240 24 cm, 9 1/2"

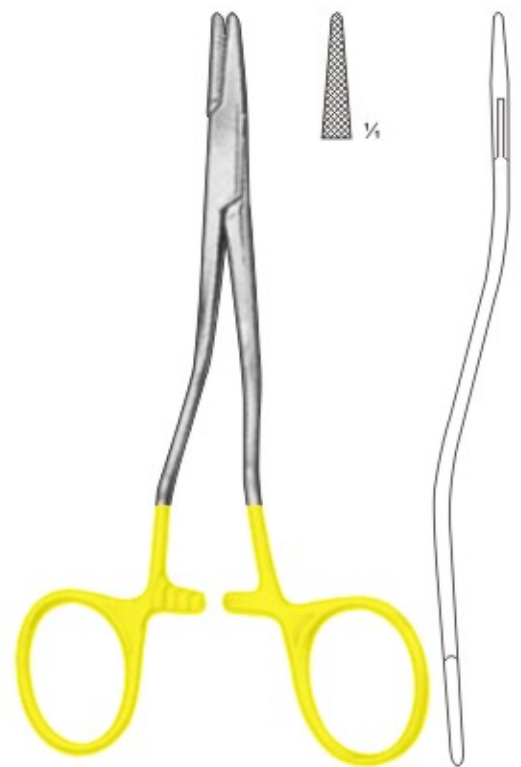

**KILNER**  
18-130-130  
13 cm, 5 1/2"

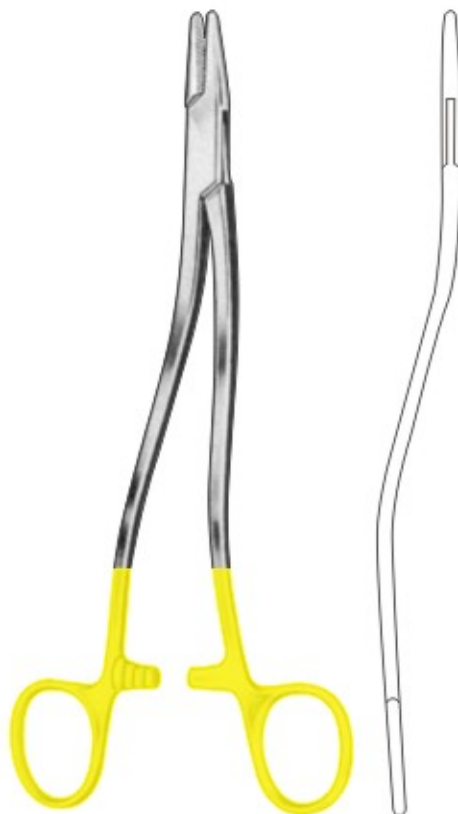

**BOZEMANN**

18-131-200  
20 cm, 8"

18-132-240  
24 cm, 9 1/4"

18-133-260  
26 cm, 10 1/4"

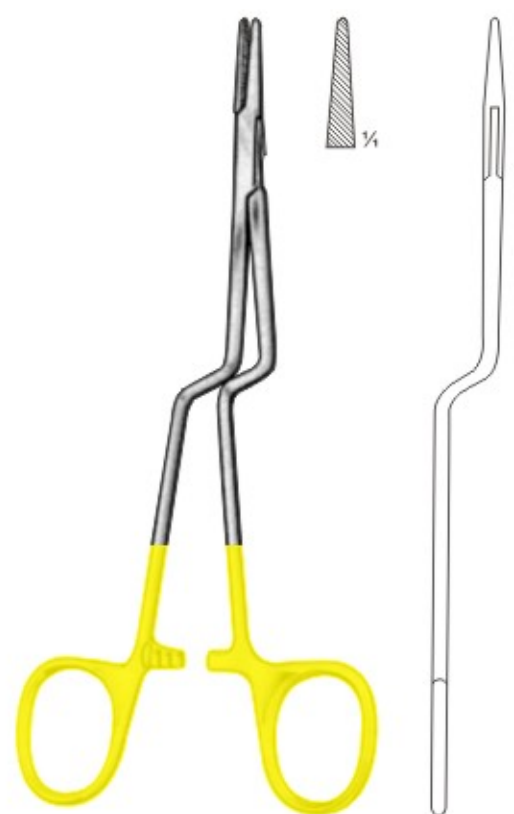

**JACOBSON**  
18-134-180 18 cm, 7"



# NEEDLE HOLDERS T.C. INSERTED

Nadelhalter  
Porta-agujas

Porte-agujas  
Portaghi

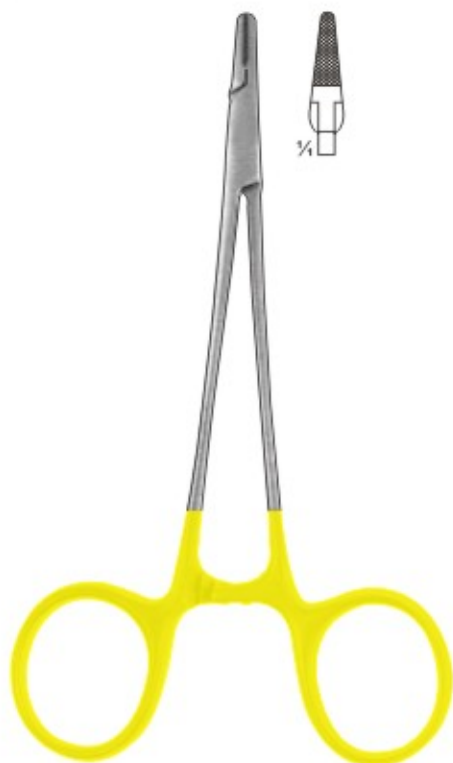

**BAUMGARTNER**  
18-135-135  
13.5 cm, 5 1/4"



**BAUMGARTNER**  
18-136-130  
13 cm, 5 1/4"  
Left handle



**OLSEN-HEGAR**



18-137-140  
14 cm, 5 1/2"



18-138-165  
16.5 cm, 6 1/2"



18-139-180  
18 cm, 7"



**CRILE-WOOD**  
18-140-150  
15 cm, 6"

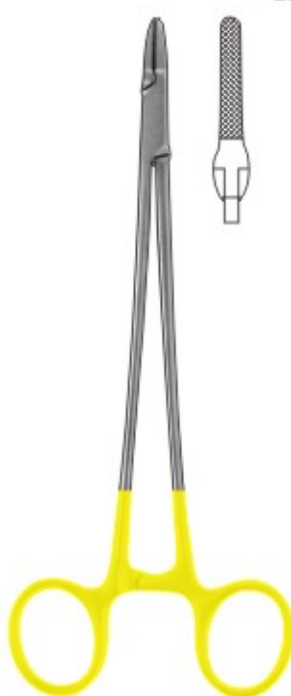

**FRENCH-EYE**  
18-141-160 16 cm, 6 1/4"  
18-142-180 18 cm, 7"  
18-143-200 20 cm, 8"  
18-144-220 22 cm, 8 3/4"  
18-145-250 25 cm, 10"



**FRENCH-EYE**  
18-146-152 15.2 cm, 6"  
18-147-178 17.8 cm, 7"  
18-148-203 20.3 cm, 8"  
18-149-254 25.4 cm, 10"

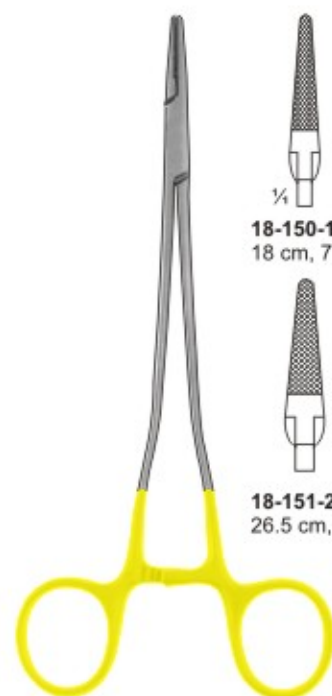

**SAROT**



18-150-180  
18 cm, 7"



18-151-265  
26.5 cm, 10 1/2"

# NEEDLE HOLDERS T.C. INSERTED

Nadelhalter  
Porta-agujas

Porte-agujas  
Portaghi

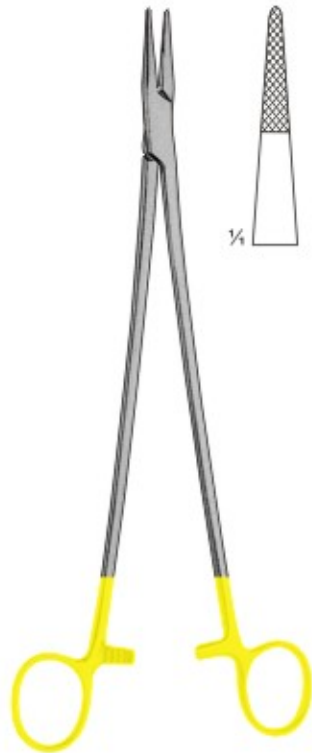

**WANGENSTEEN**  
18-152-273  
27.3 cm, 10 3/4"

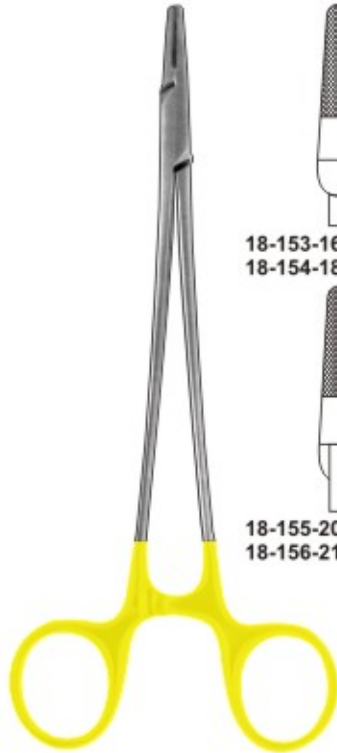

**MAYO-HEGAR**

18-153-160 16 cm, 6 1/4"  
18-154-180 18 cm, 7"

18-155-200 20 cm, 8"  
18-156-210 21 cm, 8 1/2"

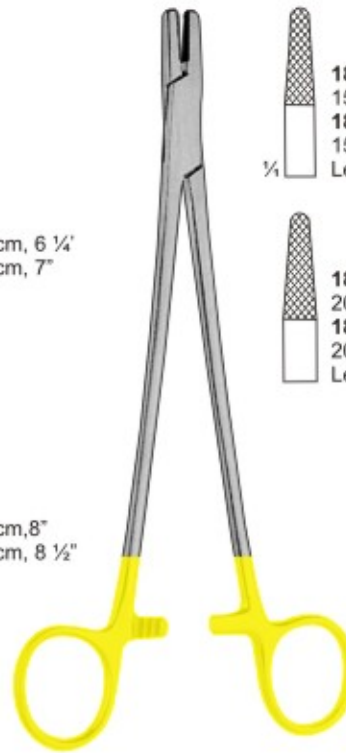

**MAYO-HEGAR**

18-157-152 15.2 cm, 6"  
18-158-152 15.2 cm, 6"  
Left handed.

18-161-203 20.3 cm, 8"  
18-162-203 20.3 cm, 8"  
Left handed.

18-159-178 17.8 cm, 7"  
18-160-178 17.8 cm, 7"  
Left handed.

18-163-230 23 cm, 9"

18-164-298 29.8 cm, 12"

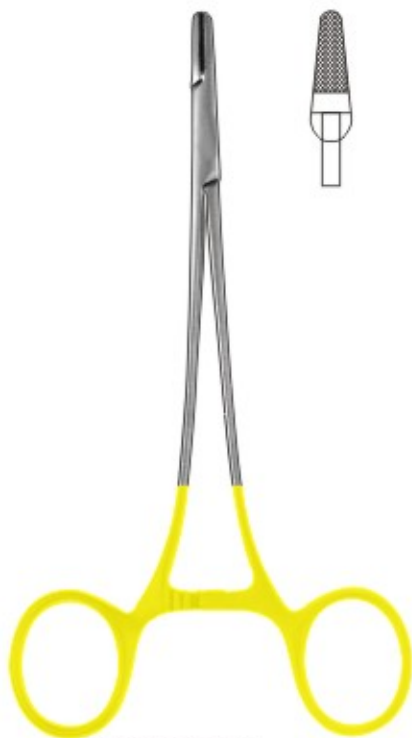

**FINOCHIETTO**  
18-165-130 13 cm, 5 1/4"  
18-166-160 16 cm, 6 1/4"  
18-167-190 19 cm, 7 1/2"  
18-168-210 21 cm, 8 1/4"



**FINOCHIETTO**  
18-169-130 13 cm, 5 1/4"  
18-170-160 16 cm, 6 1/4"  
18-171-190 19 cm, 7 1/2"

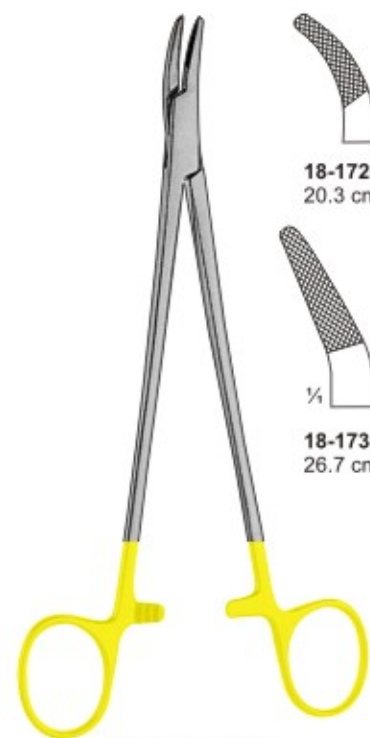

**FINOCHIETTO**  
Angled

18-172-203 20.3 cm, 8"

18-173-267 26.7 cm, 10 1/2"



## NEEDLE HOLDERS T.C. INSERTED

Nadelhalter  
Porta-agujas

Porte-agujas  
Portaghi

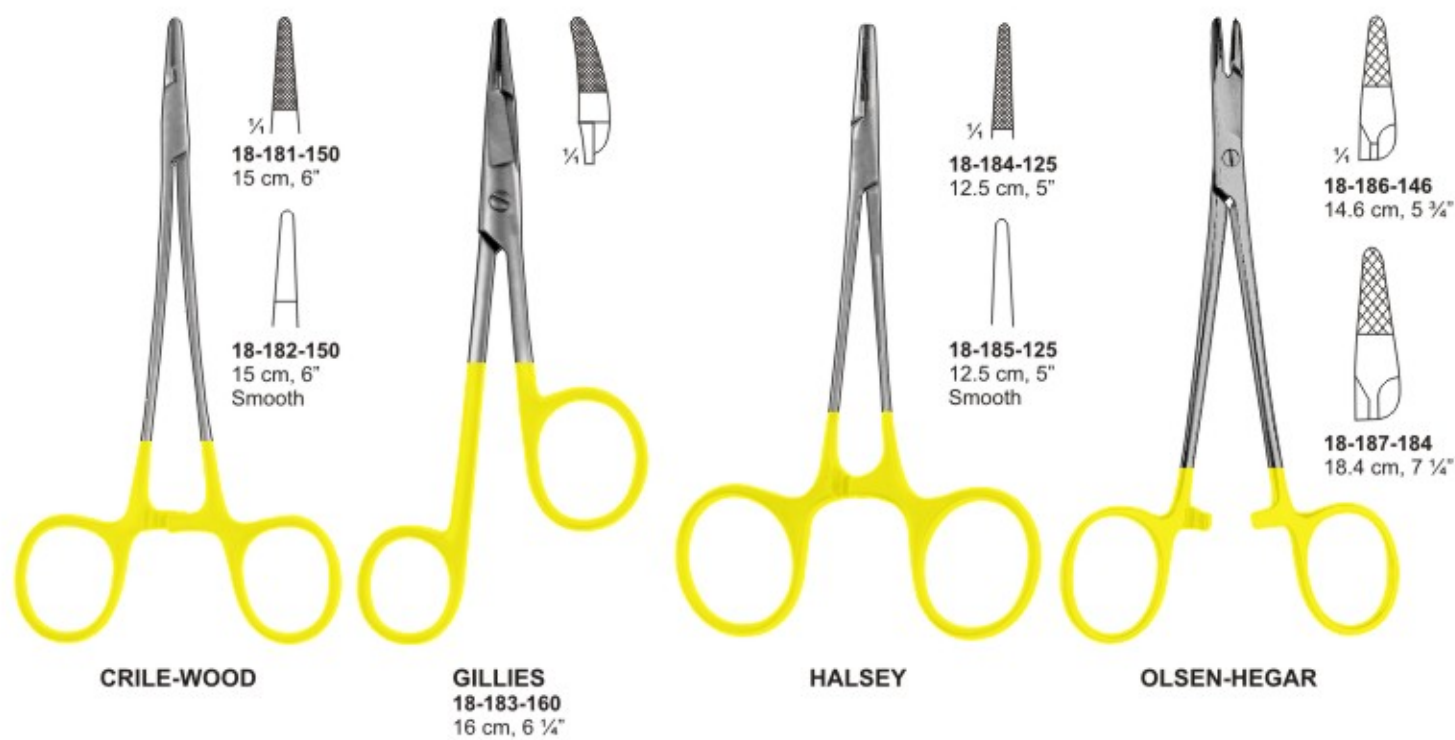
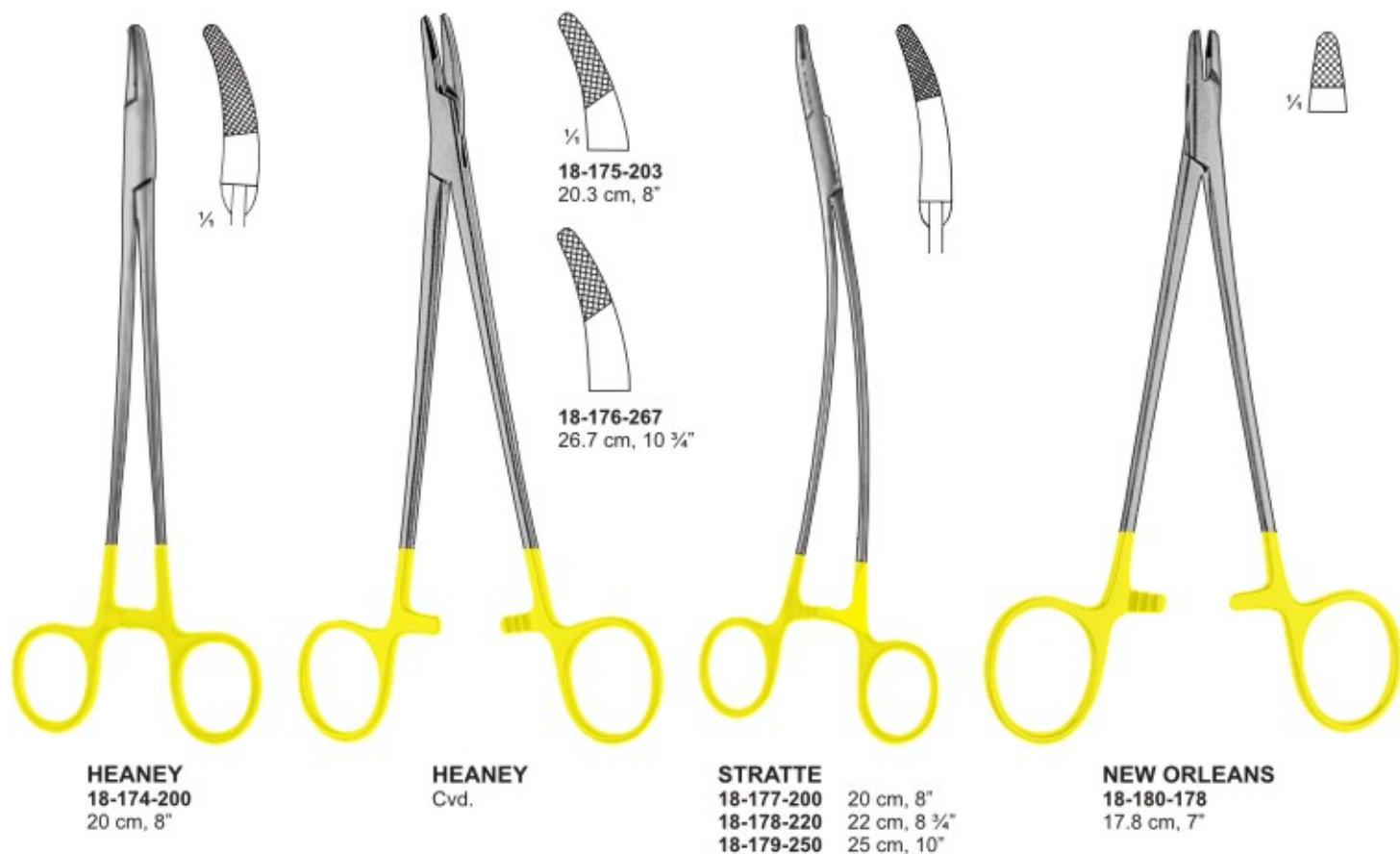

# NEEDLE HOLDERS T.C. INSERTED

Nadelhalter  
Porta-agujas

Porte-agujas  
Portaghi

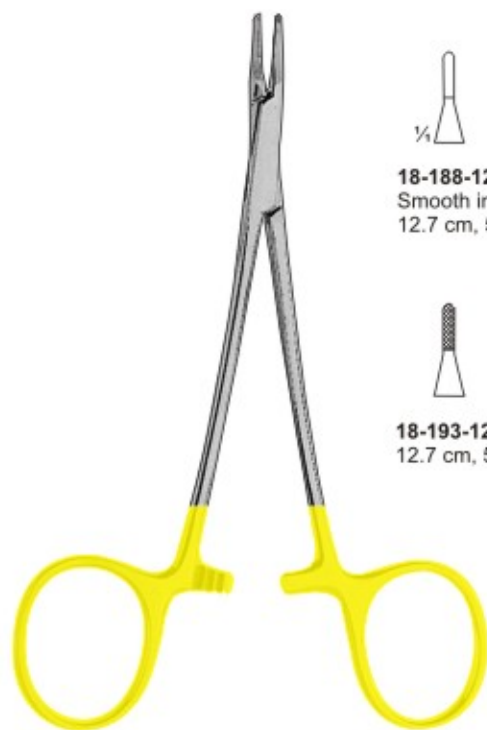

**RYDER**  
Narrow jaws.



**18-188-127**  
Smooth inserts.  
12.7 cm, 5 1/2"



**18-189-152**  
Smooth inserts.  
15.2 cm, 6"



**18-190-178**  
Smooth inserts.  
17.8 cm, 7"



**18-191-203**  
Smooth inserts.  
20.3 cm, 8"



**18-192-229**  
Smooth inserts.  
22.9 cm, 9"



**18-193-127**  
12.7 cm, 5 1/4"



**18-194-152**  
15.2 cm, 6"



**18-195-178**  
17.8 cm, 7"



**18-196-203**  
20.3 cm, 8"



**18-197-229**  
22.9 cm, 9"



**COOLEY INTRACARDIAC**  
Straight, narrow jaw.



**18-198-178**  
17.8 cm, 7"  
**18-199-203**  
20.3 cm, 8"



**18-200-229**  
22.9 cm, 9"  
**18-201-263**  
26.3 cm, 10 1/2"

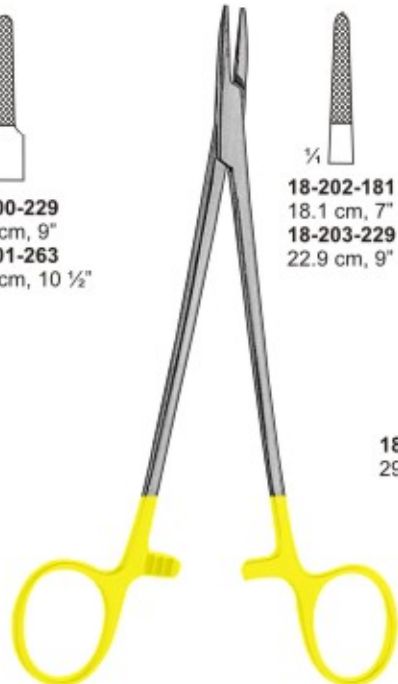

**DEBAKEY CARDIOVASCULAR**  
Delicate patterns. Straight jaw, serrated.



**18-202-181**  
18.1 cm, 7"  
**18-203-229**  
22.9 cm, 9"



**18-204-263**  
26.3 cm, 10 1/2"



**18-205-298**  
29.8 cm, 12"



**MICROVASCULAR**  
**18-206-181** 18.1 cm, 7"  
**18-207-203** 20.3 cm, 8"  
**18-208-229** 22.9 cm, 9"  
**18-209-263** 26.3 cm, 10 1/2"  
Straight jaw, serrated.





## NEEDLE HOLDERS T.C. INSERTED

Nadelhalter  
Porta-agujas

Porte-agujas  
Portaghi



**RYDER FRENCH-EYE/STANDARD/MICRO**



**18-210-130**  
13 cm, 5 1/4"  
Serrated-Solid



**18-211-150**  
15 cm, 6"  
Serrated-Solid



**18-212-180**  
18 cm, 7"  
Serrated-Solid



**18-213-200**  
20 cm, 8"  
Serrated-Solid



**18-214-230**  
23 cm, 9"  
Serrated-Solid



**18-219-180**  
18 cm, 7"  
Serrated-Solid



**18-215-260**  
26 cm, 10 1/4"  
Serrated-Solid



**18-216-130**  
13 cm, 5 1/4"  
Serrated-Micro



**18-217-160**  
16 cm, 6 1/4"  
Serrated-Micro



**18-218-180**  
18 cm, 7"  
Serrated-Micro



**18-220-260**  
26 cm, 10 1/4"  
Serrated-Solid

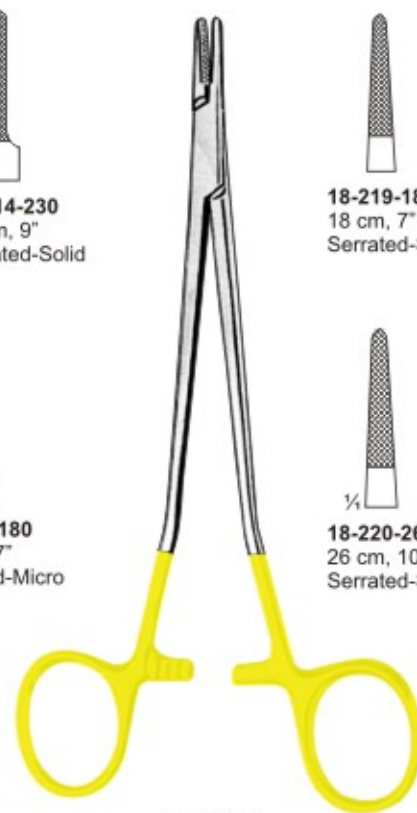

**SAROT**



**18-221-125**  
12.5 cm, 5"  
Tungsten Carbide  
Serrated-Solid



**18-222-125**  
12.5 cm, 5"  
Tungsten Carbide  
Serrated-Solid



**18-223-130**  
13 cm, 5 1/4"  
Smooth



**18-224-130**  
13 cm, 5 1/4"  
Serrated-Solid



**18-225-130**  
13 cm, 5 1/4"  
Tungsten Carbide  
Smooth



**18-226-130**  
13 cm, 5 1/4"  
Tungsten Carbide  
Serrated-Solid



**CONVERSE**



**DERF**

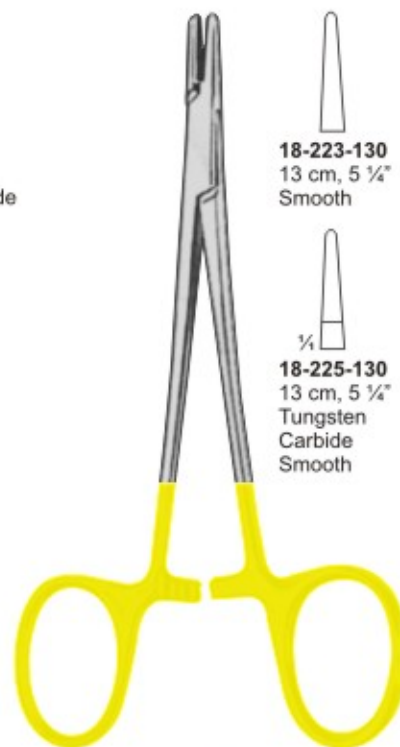

**HALSEY**

# NEEDLE HOLDERS T.C. INSERTED

Nadelhalter  
Porta-agujas

Porte-agujas  
Portaghi

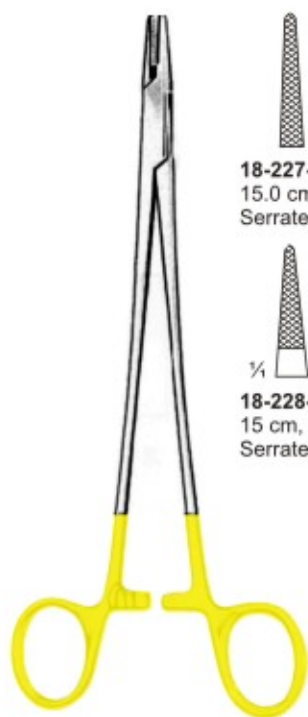

**18-227-155**  
15.0 cm, 6"  
Serrated-Solid

**18-228-150**  
15 cm, 6"  
Serrated-Solid

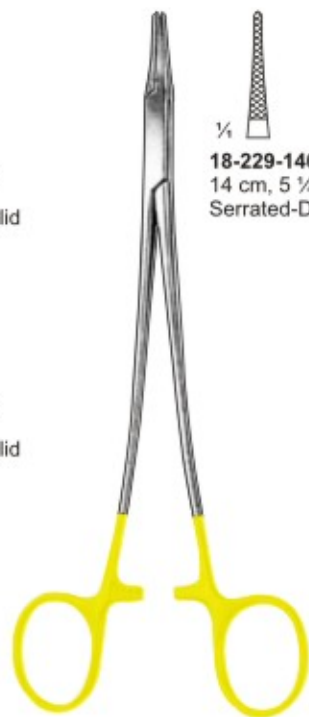

**18-229-140**  
14 cm, 5 1/4"  
Serrated-Delicate

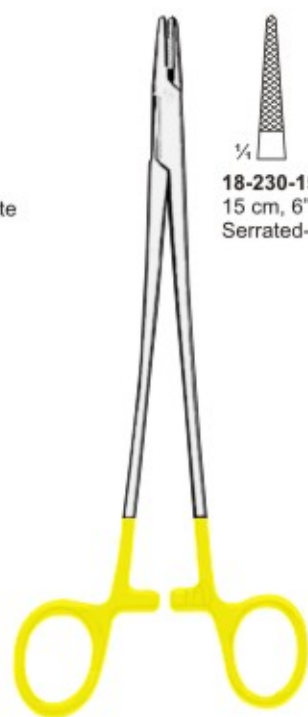

**18-230-150**  
15 cm, 6"  
Serrated-Solid

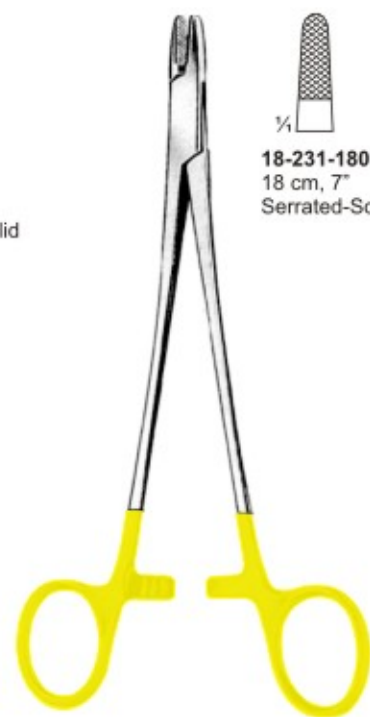

**18-231-180**  
18 cm, 7"  
Serrated-Solid

BABY CRILE-WOOD

EUFRATE PASQUE

CARROLL

NEW ORLEANS



**18-232-140**  
14 cm, 5 1/2"  
Serrated-Solid

**18-235-140**  
14 cm, 5 1/2"  
Serrated-Solid

**18-233-170**  
17 cm, 6 3/4"  
Serrated-Solid

**18-236-170**  
17 cm, 6 3/4"  
Serrated-Solid

**18-234-190**  
19 cm, 7 1/2"  
Serrated-Solid

**18-237-190**  
19 cm, 7 1/2"  
Serrated-Solid

OLSEN-HEGAR

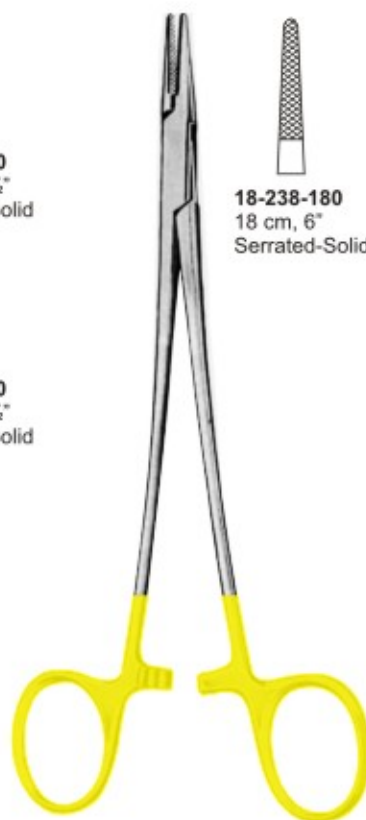

**18-238-180**  
18 cm, 6"  
Serrated-Solid

**18-239-200**  
20 cm, 8"  
Serrated-Solid

**18-240-230**  
23 cm, 9"  
Serrated-Solid

**18-241-260**  
26 cm, 10 1/4"  
Serrated-Solid

**18-242-310**  
31 cm, 12 1/4"  
Serrated-Solid

DEBAKEY-VASCULAR/EXTRA  
LIGHT



## NEEDLE HOLDERS T.C. INSERTED

Nadelhalter  
Porta-agujas

Porte-agujas  
Portaghi



**18-243-152**  
15.2 cm, 6"  
Delicate.



**18-244-152**  
15.2 cm, 6"  
**18-245-180**  
18 cm, 7"  
**18-246-200**  
20 cm, 8"  
Heavy

**WIRE TWISTERS**



**STERNUM**  
**18-247-175**  
17.5 cm, 7"  
Wire Twister



**WIRE TIGHTENING  
PLIERS**  
**18-248-180**  
18 cm, 7"

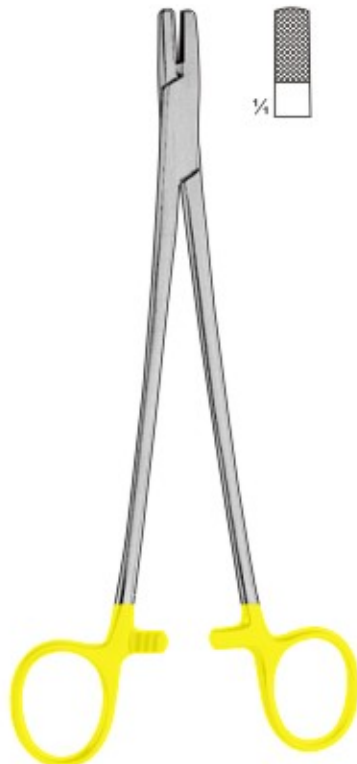

**COOLEY-BAUMGAFTEN  
WIRE TWISTER**  
**18-249-203**  
20.3 cm, 8"  
Extra heavy needle holder designed  
for twisting of wire and placement of  
retention suture. Heavy, blunt jaws.



**RUBIO WIRE TWISTER**  
**18-250-127**  
12.7 cm, 5 1/4"

# NEEDLE HOLDERS T.C. INSERTED

Nadelhalter  
Porta-agujas

Porte-agujas  
Portaghi



**MICRO DERF**

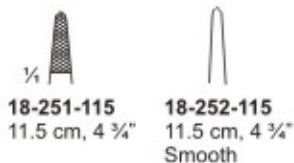

**18-251-115**  
11.5 cm, 4 3/4"

**18-252-115**  
11.5 cm, 4 3/4"  
Smooth



**DERF**  
**18-253-121**  
12.1 cm, 5"

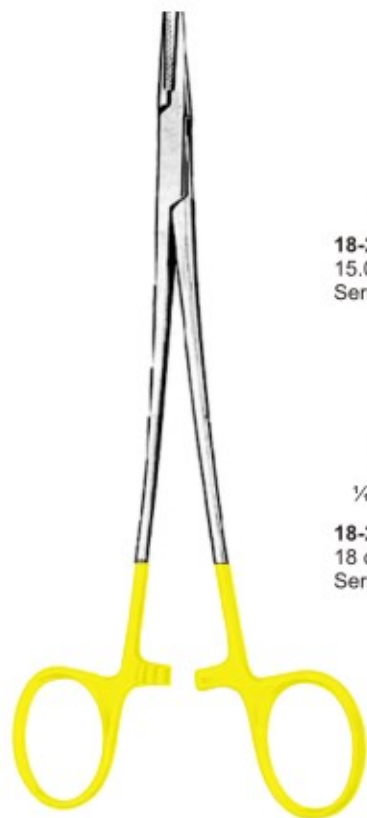

**CRILE-WOOD**

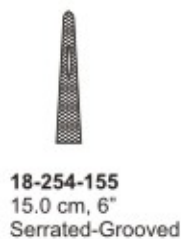

**18-254-155**  
15.0 cm, 6"  
Serrated-Grooved

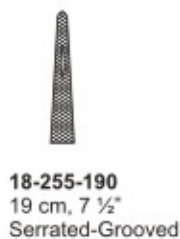

**18-255-190**  
19 cm, 7 1/2"  
Serrated-Grooved



**18-256-190**  
19 cm, 7 1/2"  
Serrated-Grooved

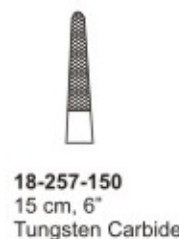

**18-257-150**  
15 cm, 6"  
Tungsten Carbide  
Serrated-Slotted

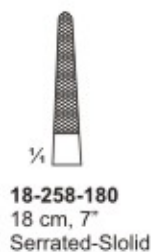

**18-258-180**  
18 cm, 7"  
Serrated-Slotted

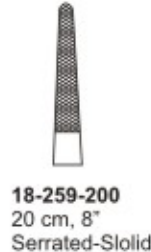

**18-259-200**  
20 cm, 8"  
Serrated-Slotted

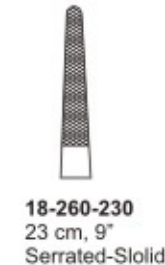

**18-260-230**  
23 cm, 9"  
Serrated-Slotted

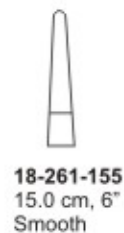

**18-261-155**  
15.0 cm, 6"  
Smooth



## NEEDLE HOLDERS T.C. INSERTED

Nadelhalter  
Porta-agujas

Porte-agujas  
Portaghi

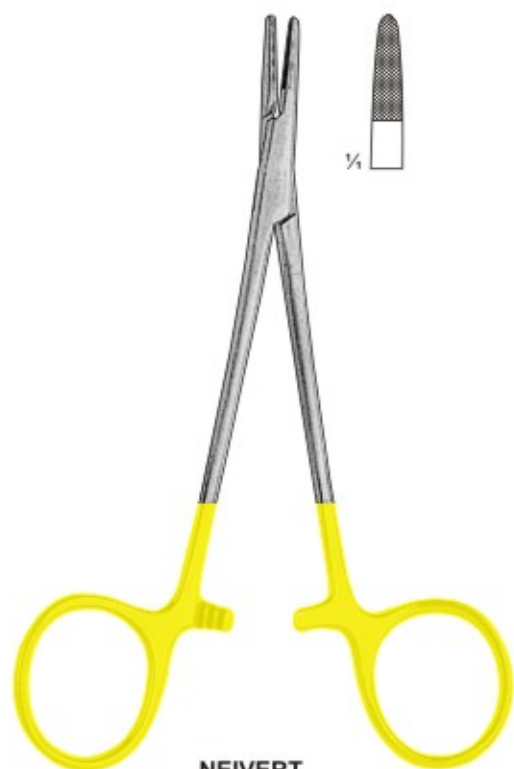

**NEIVERT**  
18-262-127  
12.7 cm, 5 1/4"

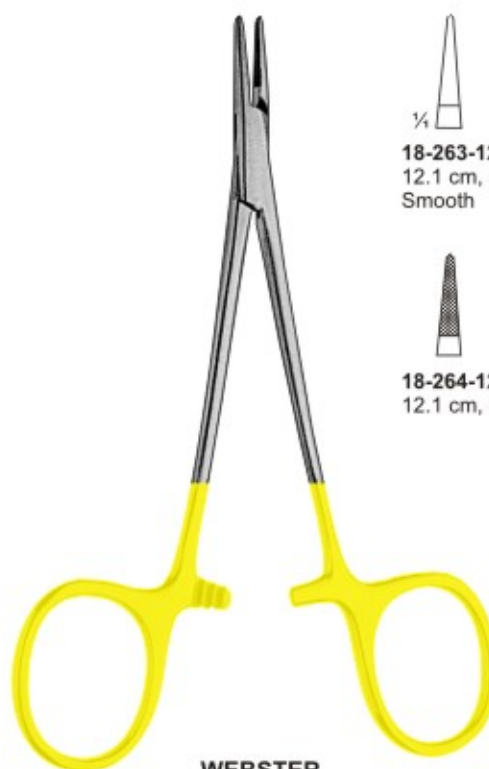

**WEBSTER**

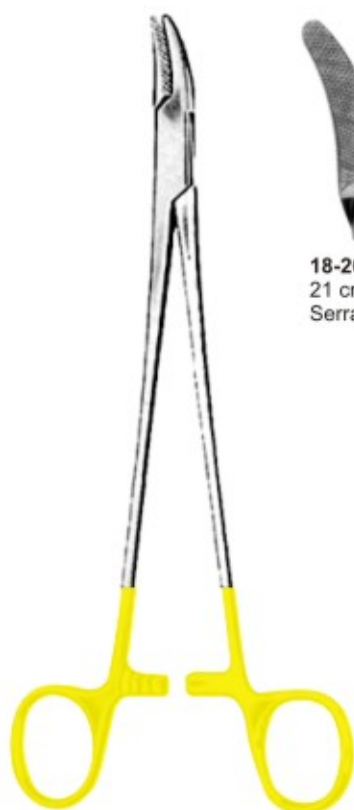

**HEANEY-GYNE**



**18-265-210**  
21 cm, 8 1/4"  
Serrated-Solid



**18-266-210**  
21 cm, 8 1/4"  
Tungsten Carbide  
Serrated-Solid



**18-267-260**  
26 cm, 10 1/4"  
Tungsten Carbide  
Serrated-Solid

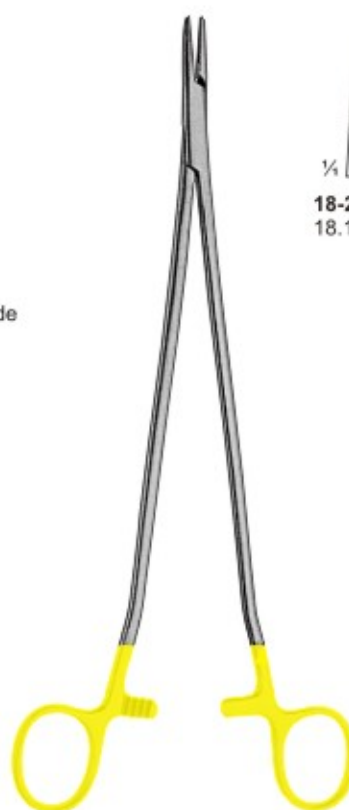

**SAROT**



**18-268-181**  
18.1 cm, 7"



**18-269-263**  
26.3 cm, 10 1/2"

# NEEDLE HOLDERS T.C. INSERTED

Nadelhalter  
Porta-agujas

Porte-agujas  
Portaghi

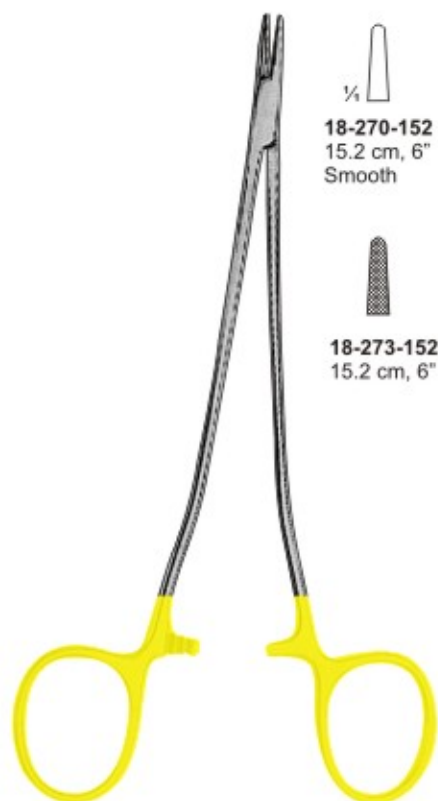

**COOLEY MICROVASCULAR**

$\frac{1}{4}$    
**18-270-152**  
15.2 cm, 6"  
Smooth

  
**18-271-171**  
17.1 cm, 6  $\frac{3}{4}$ "  
Smooth

  
**18-272-203**  
20.3 cm, 8"  
Smooth

  
**18-273-152**  
15.2 cm, 6"

  
**18-274-171**  
17.1 cm, 6  $\frac{3}{4}$ "

  
**18-275-203**  
20.3 cm, 8"

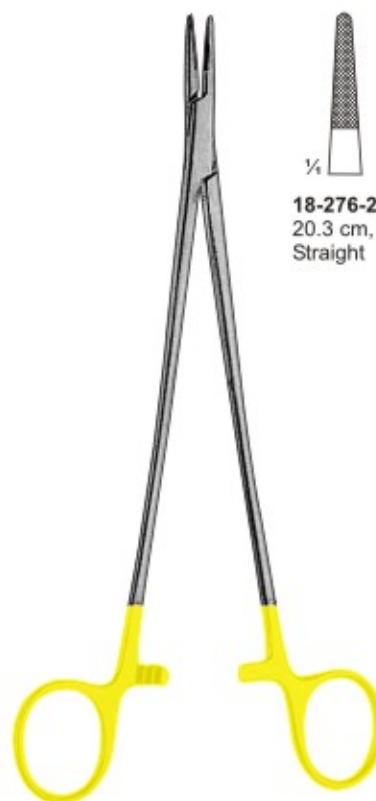

**JULIAN**

$\frac{1}{4}$    
**18-276-203**  
20.3 cm, 8"  
Straight

  
**18-277-203**  
20.3 cm, 8"  
Curved

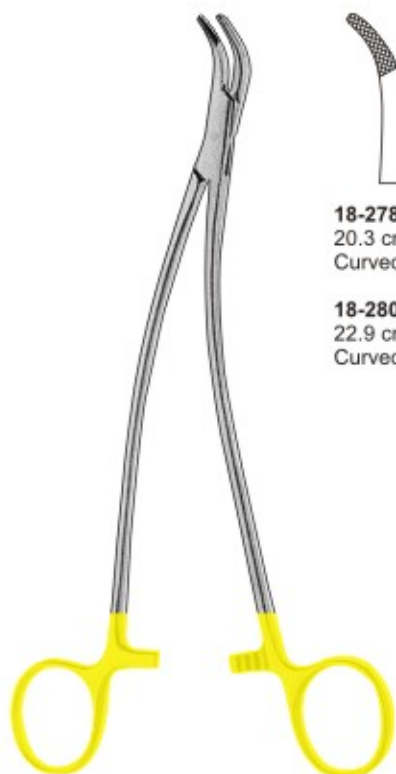

**STRATTE**

  
**18-278-203**  
20.3 cm, 8"  
Curved

  
**18-279-229**  
22.9 cm, 9"  
Curved

**18-280-229**  
22.9 cm, 9"  
Curved

**18-281-229**  
22.9 cm, 9"  
Curved



**ROCHESTER**  
**18-282-181**  
18.1 cm, 7"

$\frac{1}{4}$  



## NEEDLE HOLDERS T.C. INSERTED

Nadelhalter  
Porta-agujas

Porte-agujas  
Portaghi



**MASSON**  
18-283-263  
26.3 cm, 10 1/2"

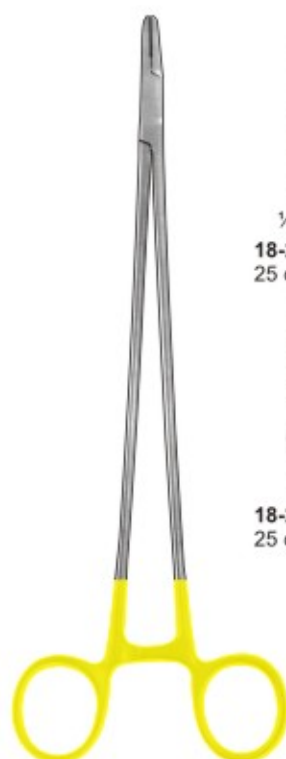

**MASSON**



**18-284-250**  
25 cm, 10"



**18-285-250**  
25 cm, 10"

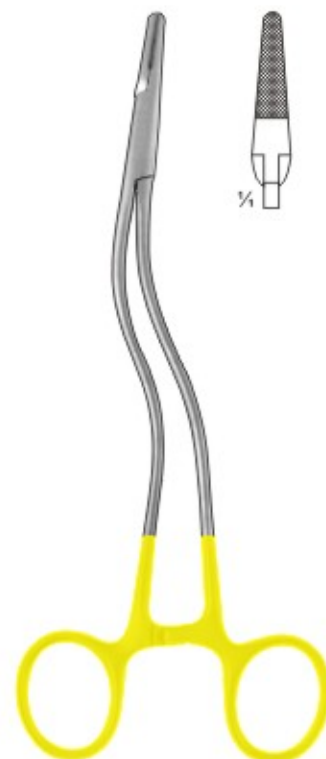

**MASSON-LUTTI-BOZEMAN**  
18-286-200 20 cm, 8"  
18-287-250 25 cm, 10"

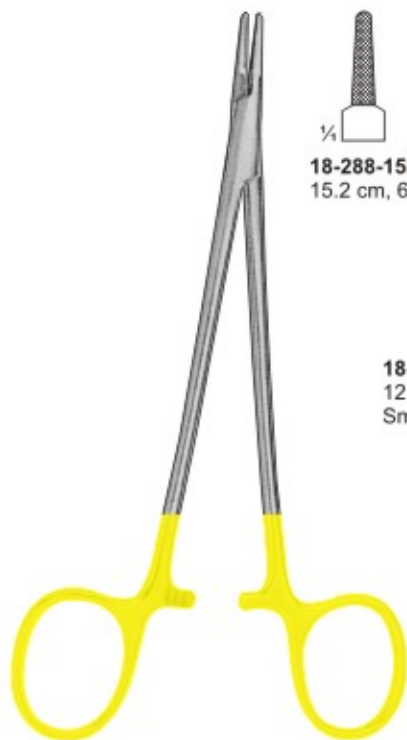

**MICROSURGICAL**



**18-288-152**  
15.2 cm, 6"



**18-289-127**  
12.7 cm, 5 1/4"



**18-290-127**  
12.7 cm, 5 1/4"  
Smooth



**O'BRIEN**  
18-291-300  
30 cm, 12"

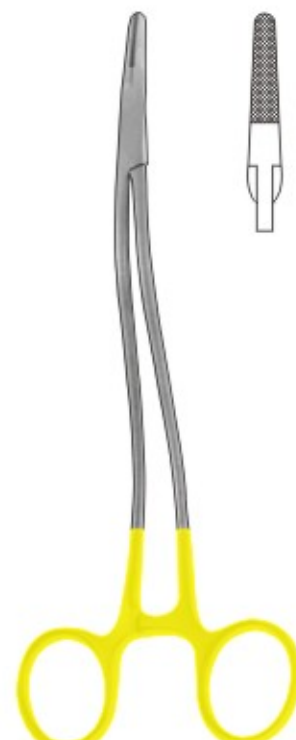

**THOMSON-WALKER**  
18-292-200 20 cm, 8"  
18-293-250 25 cm, 10"





# NEEDLE HOLDERS T.C. INSERTED

Nadelhalter  
Porta-agujas

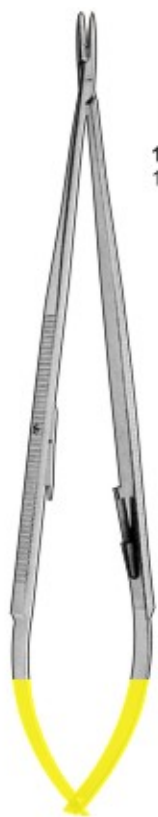

Porte-agujas  
Portaghi



 **18-294-184**  
18.4 cm, 7 1/4"  
 **18-295-222**  
22.2 cm, 8 3/4"



CASTROVIEJO



 **18-296-203**  
20.3 cm, 8"  
Straight  
 **18-297-203**  
20.3 cm, 8"  
Curved





MILLS VASCULAR



 **18-298-140**  
14 cm, 5 1/2"  
Curved  
 **18-299-140**  
14 cm, 5 1/2"  
Straight







CASTROVIEJO



 **18-300-180**  
18 cm, 7"  
Smooth  
 **18-301-210**  
21 cm, 8 1/4"  
Smooth  
 **18-302-210**  
21 cm, 8 1/4"  
Smooth  
 **18-303-210**  
21 cm, 8 1/4"  
Serrated-Solid

JACOBSON



 **18-304-140**  
14 cm, 5 1/2"  
Straight  
Smooth  
 **18-305-140**  
14 cm, 5 1/2"  
Straight  
Serrated-Solid  
 **18-306-140**  
14 cm, 5 1/2"  
Curved  
Smooth  
 **18-307-140**  
14 cm, 5 1/2"  
Straight  
Smooth  
 **18-308-140**  
14 cm, 5 1/2"  
Straight  
Serrated-Solid  
 **18-309-140**  
14 cm, 5 1/2"  
Curved  
Serrated-Solid  
 **18-310-180**  
18 cm, 7"  
Straight  
Serrated-Solid

CASTROVIEJO







# NEEDLE HOLDERS T.C. INSERTED

Nadelhalter  
Porta-agujas

Porte-agujas  
Portaghi



  
18-311-143  
14.3 cm, 5 1/2"  
Curved

  
18-313-146  
14.6 cm, 5 3/4"  
Straight

  
18-312-146  
14.6 cm, 5 3/4"  
Straight

  
18-314-184  
18.4 cm, 7 1/4"  
Straight

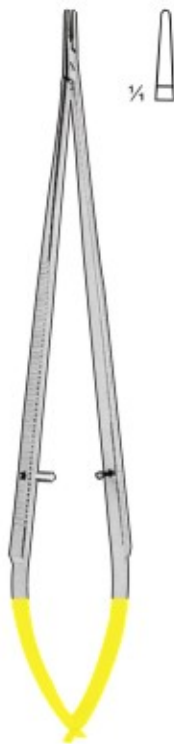



**JACOBSON**  
18-315-222  
22.2 cm, 8 3/4"







**TOENNIS**  
18-316-185  
18.5 cm, 7"





**BOYNTON**  
18-317-120  
12 cm, 5"



**ARRUGA**  
18-318-160 16 cm, 6 1/4" Str.  
18-319-160 16 cm, 6 1/4" Cvd.





**SPENCER CORONARY**  
18-320-178  
17.8 cm, 7"





**METZENBAUM**  
18-321-190  
19 cm, 7 1/2"





18-322-170  
17 cm, 6 3/4"



18-323-200  
20 cm, 8"

**MATHIEU-STILLE**

# NEEDLE HOLDERS T.C. INSERTED

Nadelhalter  
Porta-agujas

Porte-agujas  
Portaghi



**18-324-170**  
17 cm, 6 3/4"



**18-325-170**  
17 cm, 6 3/4"  
Smooth

**CASTROVIEJO**



**JACOBSON HEAVY STYLE**

**18-326-190** 19.0 cm, 7 1/2"  
**18-327-229** 22.9 cm, 9"  
**18-328-254** 25.4 cm, 10"



**18-329-135**  
13.5 cm, 5 1/4"



**18-330-135**  
13.5 cm, 5 1/4"  
Smooth

**CASTROVIEJO**



**KALT**  
**18-331-140**  
14 cm, 5 1/2" Str.



**KALT**  
**18-332-140**  
14 cm, 5 1/2" Str.



**JACOBSON**  
**18-333-185** 18.5 cm, 7 1/4"  
**18-334-210** 21.0 cm, 8 1/4"



## NEEDLE HOLDERS T.C. INSERTED

Nadelhalter  
Porta-agujas

Porte-agujas  
Portaghi



**MATHIEU-RYDER**

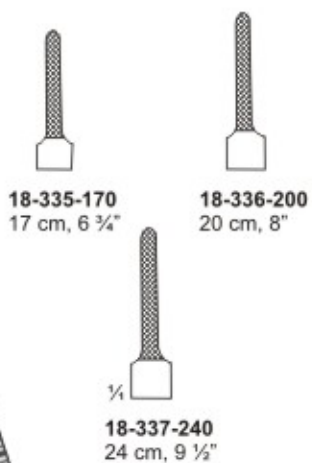

**MATHIEU-RYDER  
VASCULAR**

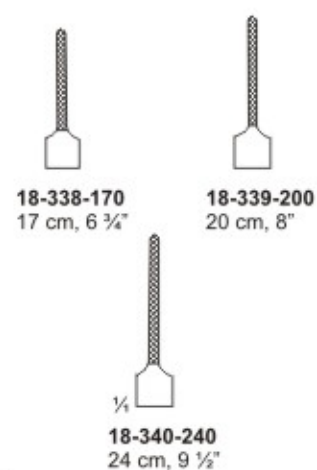

**CORWIN**



**LICHTENBERG**  
**18-344-140**  
20 cm, 8"

# NEEDLE HOLDERS T.C. INSERTED

Nadelhalter  
Porta-agujas

Porte-agujas  
Portaghi



## LANGENBECK



18-345-160  
16.0 cm, 6 1/4"



18-346-180  
18.0 cm, 7"



18-347-200  
20.0 cm, 8"

## LANGENBECK-DELICATE



18-348-180  
18.0 cm, 7"



18-349-200  
20.0 cm, 8"



18-350-230  
23.0 cm, 9"

## LANGENBECK-RYDER



18-351-180  
18.0 cm, 7"



18-352-200  
20.0 cm, 8"



18-353-230  
23.0 cm, 9"



18-354-200  
20 cm, 8"



18-355-230  
23 cm, 9"



**EISELSBERG-MATHEIU**  
18-356-185  
18.5 cm, 7 1/4"



**LUETHY-BECK**  
18-357-200  
20.0 cm, 8"



# REVERDIN NEEDLES

Reverdin nadeln  
aguja de reverdin

Aguilles de reverdin  
aghi di reverdin



REVERDIN  
short



18-358-145  
14.5cm, 5 3/4"



18-359-145  
14.5cm, 5 3/4"



18-360-145  
14.5cm, 5 3/4"



18-361-145  
14.5cm, 5 3/4"



REVERDIN NEEDLE  
18-362-195 -  
18-365-195  
Small



18-362-195  
19.5cm, 7 3/4"  
18-362-230  
23cm, 9"



18-363-195  
19.5cm, 7 3/4"  
18-363-230  
23cm, 9"



18-364-195  
19.5cm, 7 3/4"  
18-364-230  
23cm, 9"



18-365-195  
19.5cm, 7 3/4"  
18-365-230  
23cm, 9"



REVERDIN  
18-362-230 -  
18-365-230  
long



Reverdin nadeln  
agujas de reverdin

Aguilles de reverdin  
aghi di reverdin

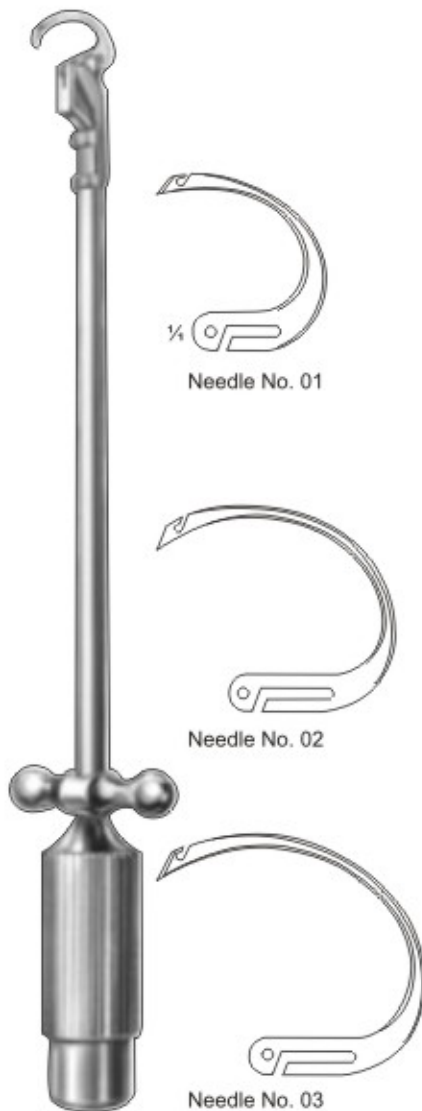

**YOUNG**  
18-366-245  
24.5 cm, 10"  
Complete  
with on  
Needle no. 01

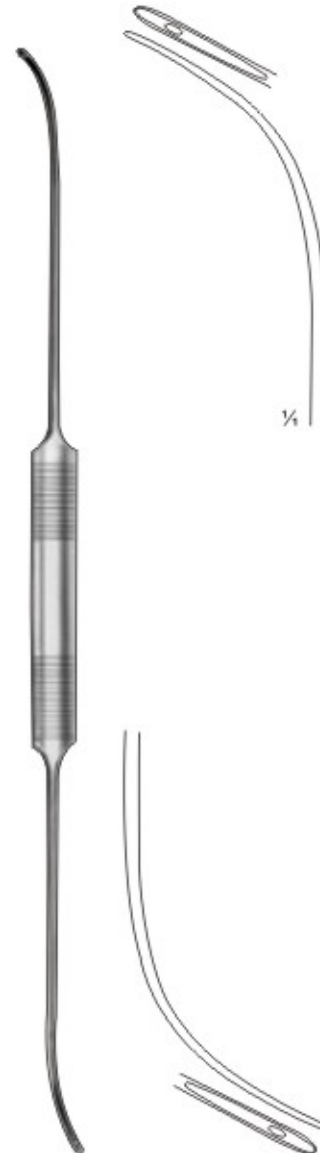

**SCHMIEDEN-DICK**  
18-367-290  
29cm, 11 1/2"  
malleable



**SCHMIEDEN**  
18-368-240  
24cm, 9 1/2"



## LIGATURE NEEDLES

Unterbindungsnadeln  
agujas para ligaduras

Aiguilles à ligatures  
aghi di legatura



**LIGATURE NEEDLE**  
18-369-200  
20cm, 8"

**COOPER**  
18-370-190  
19 cm, 7 ½"

**KRONECKER**  
18-371-130  
13 cm, 5 ¼"  
delicate  
for right hand

**KRONECKER**  
18-372-130  
13 cm, 5 ¼"  
delicate  
for left hand

**DESCHAMPS**  
18-373-240  
24 cm, 9 ½"

**DESCHAMPS**  
18-374-240  
24 cm, 9 ½"

# LIGATUTR NEEDLES



Unterbindungsnadeln  
aguja para ligaduras

Aiguilles à ligatures  
aghi di legatura



### DESCHAMPS

<b>18-375-200</b>	<b>18-376-200</b>
20cm, 8"	20cm, 8"
sharp	sharp
for right hand	for left hand



### DESCHAMPS

<b>18-377-200</b>	<b>18-378-200</b>
20cm, 8"	20cm, 8"
blunt	blunt
for right hand	for left hand



### DESCHAMPS

<b>18-379-210</b>	<b>18-380-210</b>
21cm, 8 1/4"	21cm, 8 1/4"
blunt	blunt
for right hand	for left hand

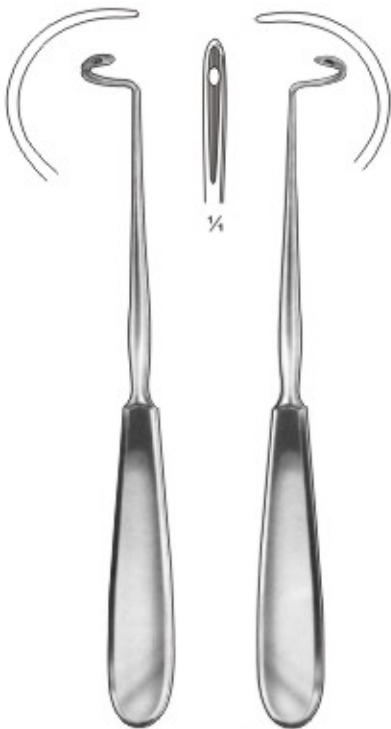

### Deschamps

<b>18-381-200</b>	<b>18-382-200</b>
20cm	20cm
blunt	blunt
for right hand	for left hand



### Deschamps

<b>18-383-200</b>	<b>18-384-200</b>
20cm	20cm
sharp	sharp
for right hand	for left hand

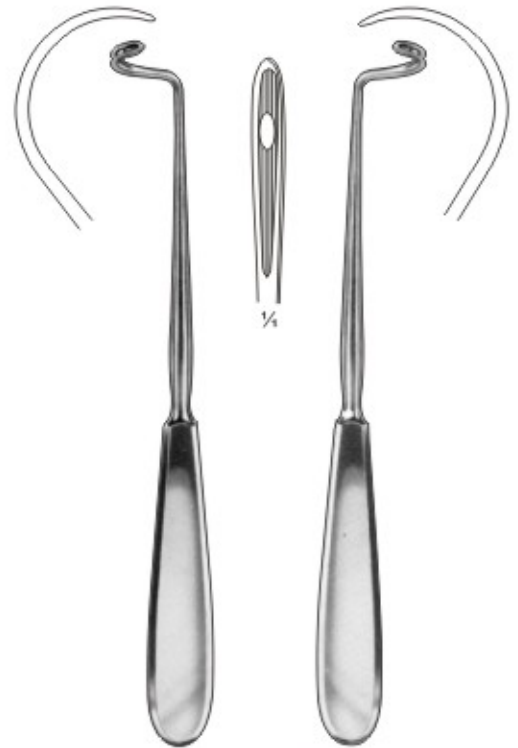

### Deschamps

<b>18-385-200</b>	<b>18-386-200</b>
20cm	20cm
blunt	blunt
for right hand	for left hand





## LIGATUTR NEEDLES

Unterbindungsnadeln  
aguja para ligaduras

Aiguilles à ligatures  
aghi di legatura



### DESCHAMPS

<b>18-387-200</b> 20cm, 8" sharp for right hand	<b>18-388-200</b> 20cm, 8" sharp for left hand
---	--

### DESCHAMPS

<b>18-389-270</b> 27cm, 10 3/4" blunt for right hand	<b>18-390-270</b> 27cm, 10 3/4" blunt for left hand
--	---

### DESCHAMPS

<b>18-391-270</b> 27cm, 10 3/4" sharp for right hand	<b>18-392-270</b> 27cm, 10 3/4" sharp for left hand
--	---

### DESCHAMPS

<b>18-393-280</b> 28cm, 11" blunt for right hand	<b>18-394-280</b> 28cm, 11" blunt for left hand
--	---

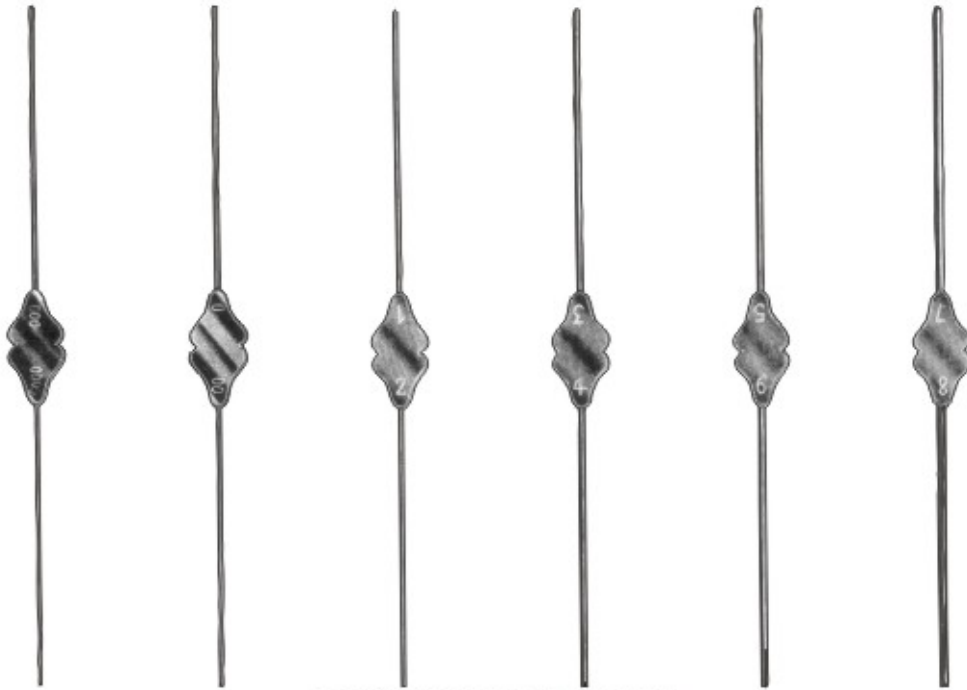

### BOWMAN LACRIMAL PROBES

Double Ended, Sterling Silver

**18-395-001**  
Bowman Probe,  
000-0000

**18-396-002**  
Bowman Probe,  
00-0

**18-397-003**  
Bowman Probe,  
1-2

**18-398-004**  
Bowman Probe,  
3-4

**18-399-005**  
Bowman Probe,  
5-6

**18-400-006**  
Bowman Probe,  
7-8

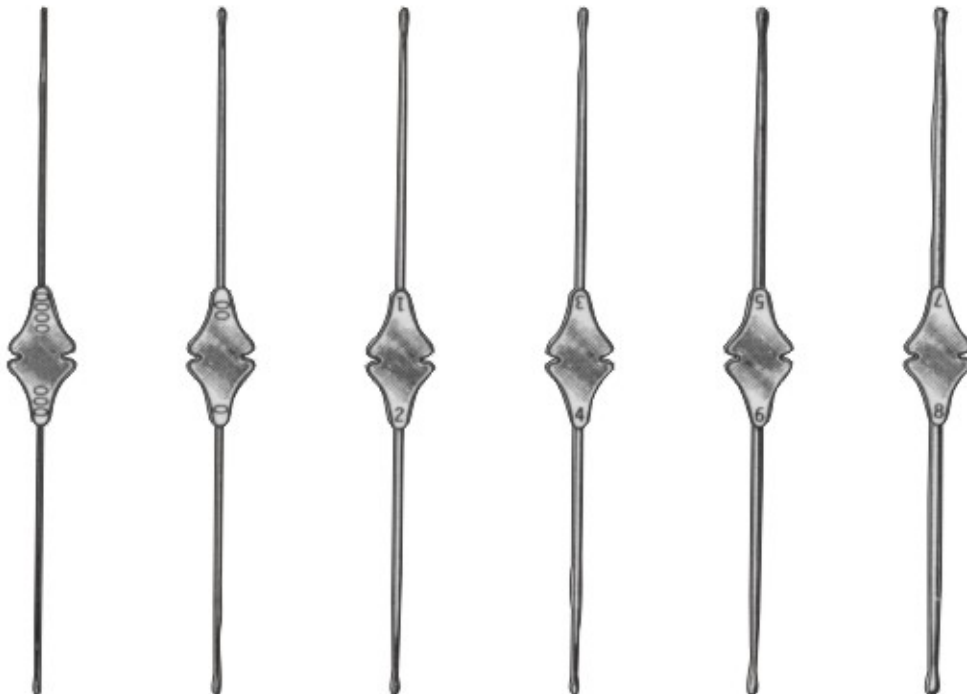

### WILLIAM LACRIMAL PROBES

Double Ended, Sterling Silver

**18-401-001**  
William Probe,  
000-0000

**18-402-002**  
William Probe,  
00-0

**18-403-003**  
William Probe,  
1-2

**18-404-004**  
William Probe,  
3-4

**18-405-005**  
William Probe,  
5-6

**18-406-006**  
William Probe,  
7-8



# GENERAL INSTRUMENTS

Allgemeines Instrumentarium  
Instrumental general

Instrumentation générale  
Strumentario generale

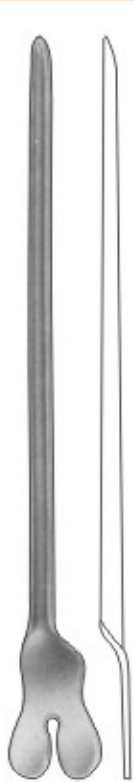

**DIRECTORS**  
18-407-130 13 cm, 5"  
18-408-145 14.5 cm, 5 3/4"  
18-409-116 16 cm, 6"

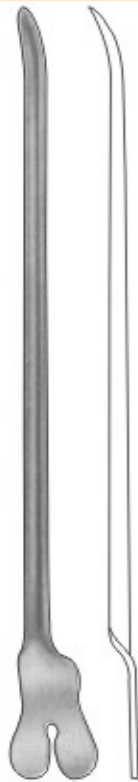

**DOYEN**  
18-410-145  
14.5 cm, 5 3/4"



**NELATON**  
18-411-160  
16 cm, 6"



**18-412-140**  
14 cm, 5 1/2"  
Director with tip  
Diam. Of tip 3.3 mm

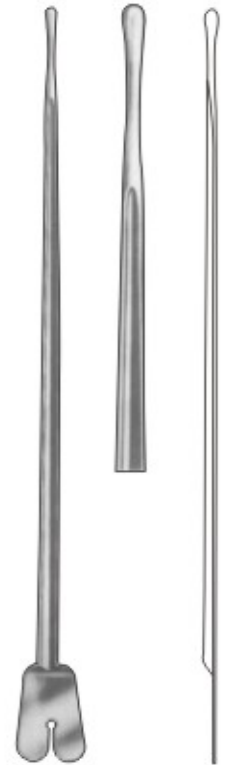

**BRODIE**  
18-413-200  
20 cm, 8"  
Director with tip  
Diam. Of tip 3.5 mm



**LOCKHART-MUMMERY**  
18-414-165  
16.5 cm, 6 1/2"

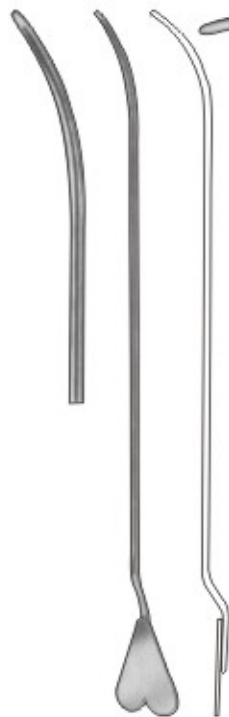

**LOCKHART-MUMMERY**  
18-415-165  
16.5 cm, 6 1/2"

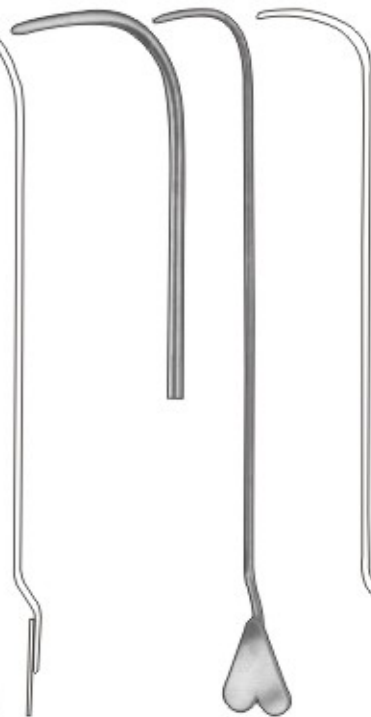

**LOCKHART-MUMMERY**  
18-416-165  
16.5 cm, 6 1/2"

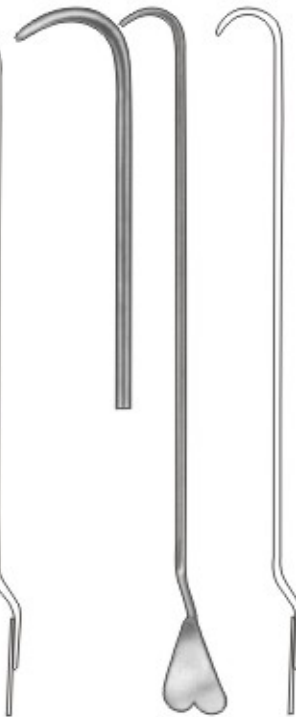

**LOCKHART-MUMMERY**  
18-417-165  
16.5 cm, 6 1/2"



**18-418-190**  
19 cm, 7 1/4"  
director with wire  
loop, malleable



**18-419-145** 14.5 cm, 5 ¾"  
**18-420-160** 16.0 cm, 6 ¼"  
**18-421-200** 20.0 cm, 8"  
probes with eye



**18-422-145**  
14.5 cm, 5 ¾"  
Myrtle leaf probe



**18-423-130** 13.0 cm, 5"  
**18-424-145** 14.5 cm, 5 ¾"  
**18-425-160** 16.0 cm, 6 ¼"  
**18-426-185** 18.5 cm, 7"  
**18-427-200** 20.0 cm, 8"



**18-428-001**  
probe



**18-429-190**  
19.0 cm, 8 ¼"  
Double ended probe,  
malleable, diam, of tips  
3 mm with hole



**18-430-250** 25.0 cm, 10"  
**18-431-300** 30.0 cm, 12"  
Double ended probes,  
tin, malleable, diam, of tips  
3.5 mm with hole



**18-432-400**  
40.0 cm, 15 ¾"  
Double ended probes,  
tin, malleable, diam, of tips  
4 mm with hole



**18-433-300** 1.5 mm  
**18-434-300** 2.0 mm  
**18-435-300** 2.5 mm  
30.0 cm, 12"



## GENERAL INSTRUMENTS

Allgemeines Instrumentarium  
Instrumental general

Instrumentation générale  
Strumentario generale



**STACKE**  
18-436-100  
10.0 cm, 4"



**KILLIAN**  
18-437-165  
16.5 cm, 6 1/2"



**18-438-165**  
16.5 cm, 6 1/2"



**SEIFFERT**  
18-439-180  
18.0 cm, 7"



**SPATULA**  
18-440-145  
14.5 cm, 5 3/4"



**SPATULA**  
18-441-145  
14.5 cm, 5 3/4"



**MODELL PICCOLO**  
18-442-110  
11.0 cm, 4 1/4"  
Round Serrated



**MODELL PICCOLO**  
18-443-110  
11.0 cm, 4 1/4"  
Triangular Serrated end



**FARRELL**  
18-444-110  
11.0 cm, 4 1/4"  
Round Serrated end



**LATHBURY-FARREL**  
18-445-110  
11.0 cm, 4 1/4"  
Triangular Serrated end

# GENERAL INSTRUMENTS



Allgemeines Instrumentarium  
Instrumental general

Instrumentation générale  
Strumentario generale



**BUCK**  
**18-446-120**  
12.0 cm, 4 1/4"  
rough, spiral end

**MARTIN**  
**18-447-120**  
12 cm, 5"  
**18-448-140**  
14 cm, 5 1/2"  
**18-449-160**  
16 cm, 6 1/4"

**18-450-140**  
14.0 cm, 5 1/4"  
Triangular serrated end

**18-451-140**  
14.0 cm, 5 1/4"  
rough, spiral end

**18-452-140**  
14.0 cm, 5 1/4"  
rough, spiral end

**18-453-140**  
14.0 cm, 5 1/4"  
rough, spiral end

**FARRELL**  
**18-454-140**  
14.0 cm, 5 1/4"  
Round, serrated end

**LATHBURY-FARRELL**  
**18-455-140**  
14.0 cm, 5 1/4"  
Triangular serrated end

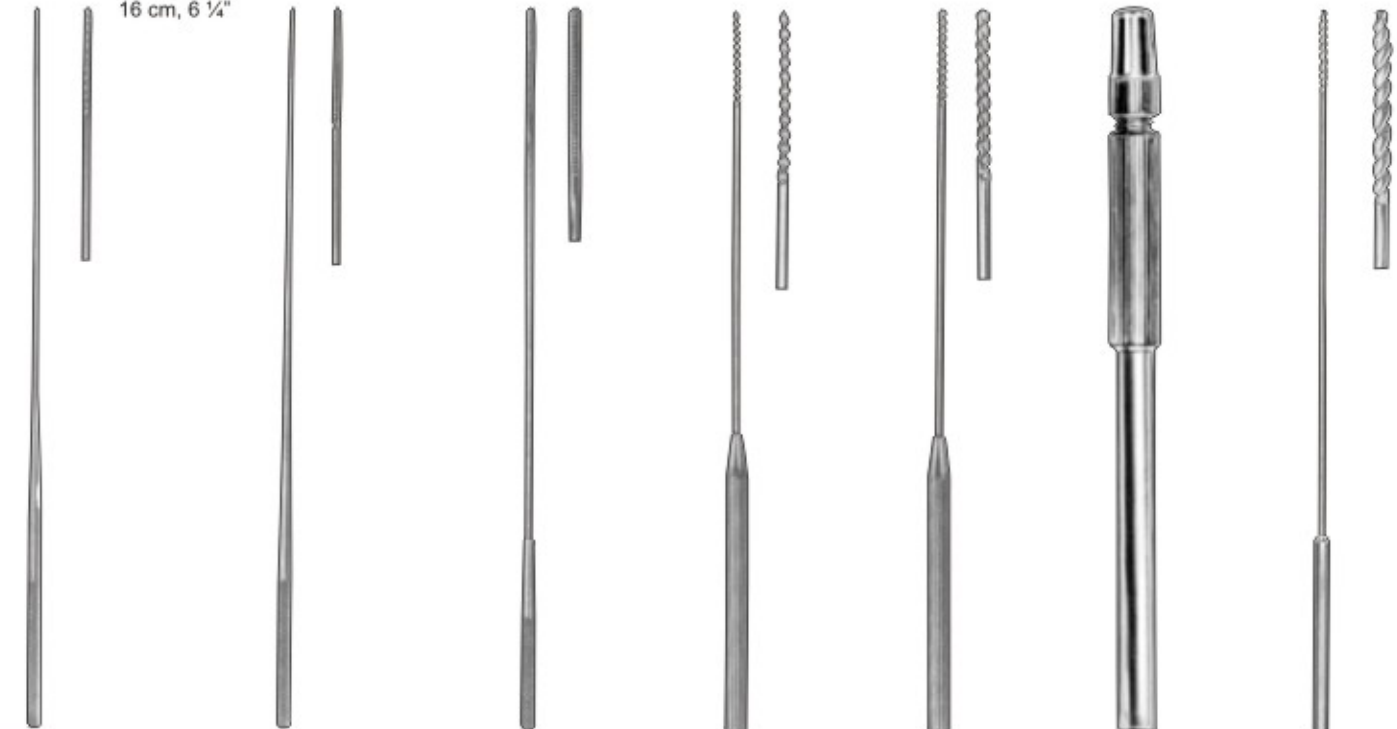

**FARRELL**  
**18-456-160**  
16.0 cm, 6 1/4"  
Rough spiral end

**LATHBURY-FARRELL**  
**18-457-160**  
16.0 cm, 6 1/4"  
Triangular serrated end

**18-458-160**  
16.0 cm, 6 1/4"  
Triangular serrated end

**18-459-180**  
18.0 cm, 7"  
Rough spiral end

**18-460-180**  
18.0 cm, 7"  
Rough spiral end

**VOLLMAR**  
**18-461-115**  
11.5 cm, 4 1/2"

**18-462-270**  
27.0 cm, 10 3/4"  
Rough spiral end



## GENERAL INSTRUMENTS

Allgemeines Instrumentarium  
Instrumental general

Instrumentation générale  
Strumentario generale



**OCHSNER**  
18-463-140  
14 cm, 5 1/2"



**LANGE**  
18-464-100  
10 cm, 4"



**CHILDE**  
18-465-180  
18 cm, 7"



**MICHEL**  
18-466-120  
12 cm, 4 3/4"



**WACHENFELDT**  
18-467-125  
12.5 cm, 5"



**HEGENBARTH**  
18-468-125  
12.5 cm, 5"



**WACHENFELDT**  
18-469-125  
12.5 cm, 5"



**MICHEL**  
18-470-120  
12 cm, 4 3/4"



**MOD. MICHEL**  
18-471-120  
12 cm, 4 3/4"



**COLLIN**  
18-472-130  
13 cm, 5"



**RICHTER-HEATH**  
18-473-140  
14 cm, 5 1/2"

# GENERAL INSTRUMENTS

Allgemeines Instrumentarium  
Instrumental general

Instrumentation générale  
Strumentario generale



**CUTICLE NIPPER**  
18-474-110  
11 cm, 4 1/2"



**NAIL NIPPER**



18-475-140  
14 cm, 5 1/2"  
Straight



18-476-140  
14 cm, 5 1/2"  
Concave



**NAIL CLIPPER**  
18-477-140  
14 cm, 5 1/2"  
Angled / Concave



**NAIL NIPPER**  
18-478-130  
13 cm, 5 1/4"  
Straight



**NAIL NIPPER**  
18-479-105  
10.5 cm, 4"



**NAIL NIPPER**  
18-481-152  
15.0 cm, 6"  
Barrel Spring  
Concave



**NAIL NIPPER**  
18-482-130  
13 cm, 5 1/4"  
Barrel Spring  
Concave





# RETRACTORS

---

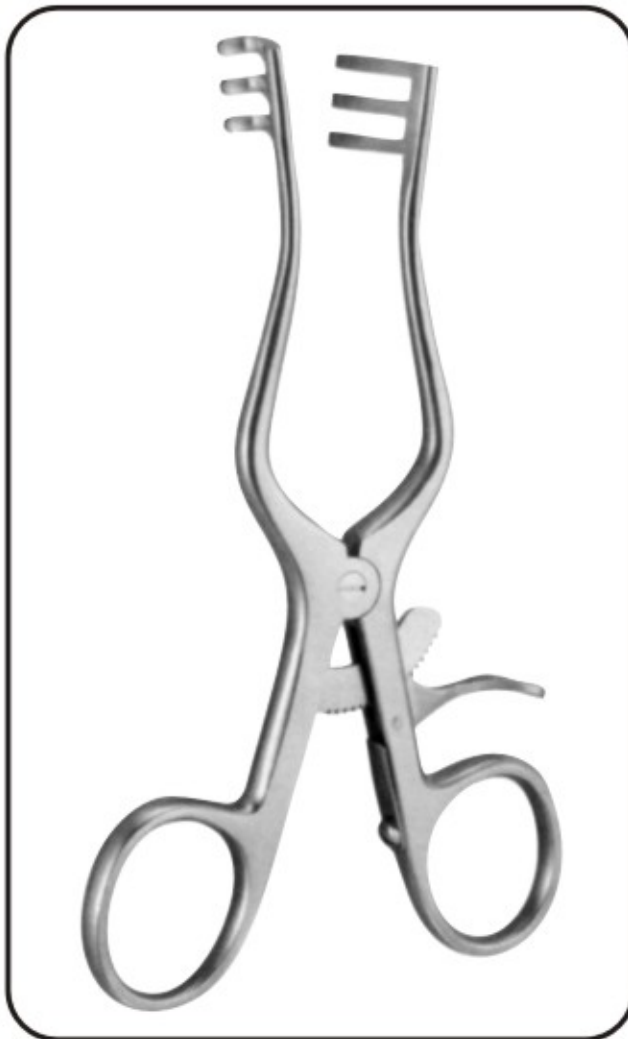

# HOOKLET & SKIN HOOKS



Wundhäkchen, Mikrohäkchen  
Ganchito, Micro Ganchitos

Crochet, Micro crochetes  
Divaricatore, Micro Divaricatori

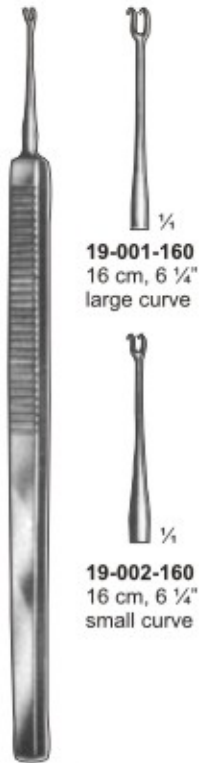

**19-001-160**  
16 cm, 6 1/4"  
large curve

**19-002-160**  
16 cm, 6 1/4"  
small curve

**GUTHRIE**



**19-003-180**  
18 cm, 7"  
Sharp

**19-004-180**  
18 cm, 7"  
sharp

**GILLIES**



**19-005-150**  
15 cm, 6"  
blunt

**KILNER**



**19-006-185**  
18.5 cm, 7 1/4"  
sharp

**19-007-185**  
18.5 cm, 7 1/4"  
sharp

**FISCH**

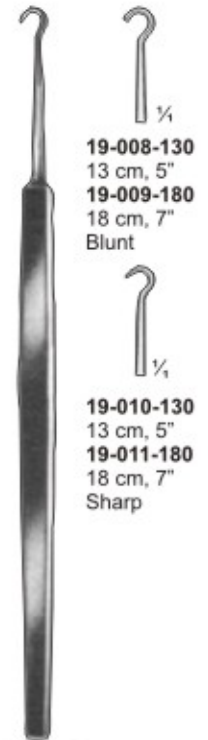

**19-008-130**  
13 cm, 5"  
**19-009-180**  
18 cm, 7"  
Blunt

**19-010-130**  
13 cm, 5"  
**19-011-180**  
18 cm, 7"  
Sharp

**FRAZIER**



**DOUBLE PRONG  
MICRO HOOK**  
**19-012-145**  
Sharp, 2mm, wide jaws,  
14.5 cm, 6 1/4"



**WIENER HOOK**  
**19-013-140**  
Sharp,  
14 cm, 5 1/2"



**TOENNIS**  
**19-014-150**  
15 cm, 6"  
Sharp



**19-015-130**  
2 x sharp  
13 cm, 5"

**19-016-130**  
4 x sharp  
13 cm, 5"

**19-017-130**  
4 x blunt  
13 cm, 5"

**ROLLET**



**19-018-150**  
sharp  
15 cm, 6"

**FREER**



# HOOKLET & SKIN HOOKS

Wundhäkchen, Mikrohäkchen  
Ganchito, Micro Ganchitos

Crochet, Micro crochetes  
Divaricatore, Micro Divaricatori

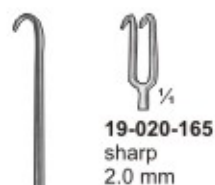

**19-020-165**  
sharp  
2.0 mm



**19-021-165**  
Sharp  
5.0 mm



**19-022-165**  
Sharp  
7.0 mm

**JOSEPH**  
**19-019-165**  
16.5 cm, 6 1/2"



**COTTLE**  
**19-023-160**  
16 cm, 6 1/4"  
Sharp

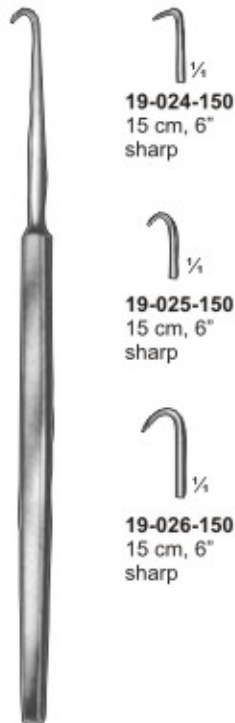

**COTTLE**



**19-024-150**  
15 cm, 6"  
sharp



**19-025-150**  
15 cm, 6"  
sharp

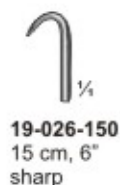

**19-026-150**  
15 cm, 6"  
sharp



**NIRO**  
**19-027-170**  
17 cm, 6 3/4"



**NIRO**  
**19-028-170**  
17 cm, 6 3/4"



**NIRO**  
**19-029-170**  
17 cm, 6 3/4"

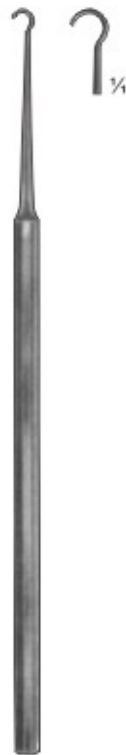

**NIRO**  
**19-030-170**  
17 cm, 6 3/4"



**ALLPORT**  
**19-031-160**  
16 cm, 6 1/2"



**YANKAUER**  
**19-032-150**  
15 cm, 6"



**SACHS**  
**19-033-210**  
21 cm, 8 1/4"

Wundhäkchen  
Ganchito

**HOOKLET**

Crochet  
Divaricatore

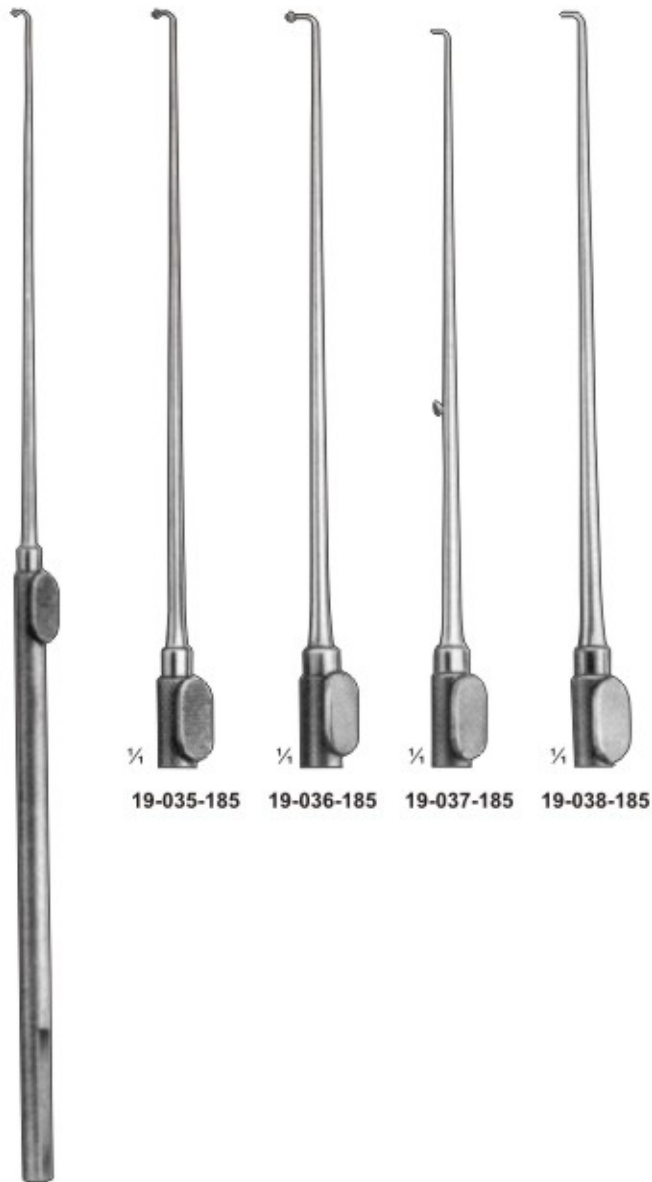

$\frac{1}{4}$  19-035-185     $\frac{1}{4}$  19-036-185     $\frac{1}{4}$  19-037-185     $\frac{1}{4}$  19-038-185

**KRAYENBUHL**  
19-034-185  
18.5cm 7"



$\frac{1}{4}$  19-040-245     $\frac{1}{4}$  19-041-245     $\frac{1}{4}$  19-042-245     $\frac{1}{4}$  19-043-245

**CASPAR**  
19-039-245  
24.5cm 9.5"



# HOOKLET & SKIN HOOKS

Wundhäkchen, Mikrohäkchen  
Ganchito, Micro Ganchitos

Crochet, Micro crochetes  
Divaricatore, Micro Divaricatori



**CRILE**  
19-044-200 20 cm, 8"



**GRAEFE**  
19-045-130 13.0 cm, 5" - A  
19-046-140 14.0 cm, 5 1/2" - B  
19-047-150 15.0 cm, 6" - C

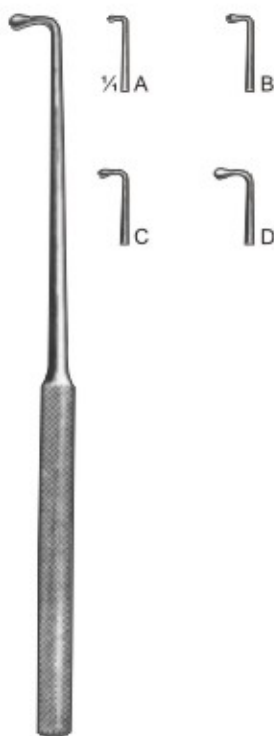

**WAGENER**  
19-048-140 14 cm, 5 1/2" - A  
19-049-140 14 cm, 5 1/2" - B  
19-050-140 14 cm, 5 1/2" - C  
19-051-140 14 cm, 5 1/2" - D



**DAY**  
19-052-160 16 cm, 6 1/4" - A  
19-053-160 16 cm, 6 1/4" - B



**LUCAE**  
19-054-140 14 cm, 5 1/2" - A  
19-055-140 14 cm, 5 1/2" - B  
19-056-140 14 cm, 5 1/2" - C



**MANNERFELT-LANGENBECK**  
19-057-155 15 x 6 mm 15.5 cm, 6" Fig.1  
19-058-155 20 x 6 mm 15.5 cm, 6" Fig.2  
19-059-155 25 x 6 mm 15.5 cm, 6" Fig.3  
19-060-155 30 x 8 mm 15.5 cm, 6" Fig.4

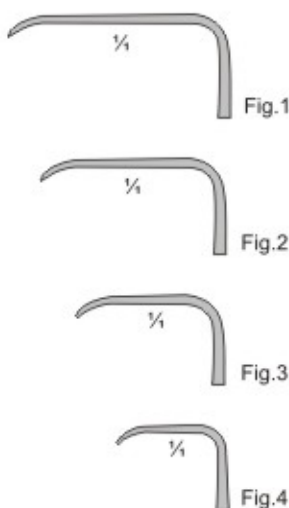

**MANNERFELT**  
15.5 cm, 6"  
large curve, blunt



19-061-155  
Sharp



19-062-155  
Blunt



19-063-155  
Blunt

# HOOKLET & SKIN HOOKS



Wundhäkchen, Mikrohäkchen  
Ganchito, Micro Ganchitos

Crochet, Micro crochetes  
Divaricatore, Micro Divaricatori

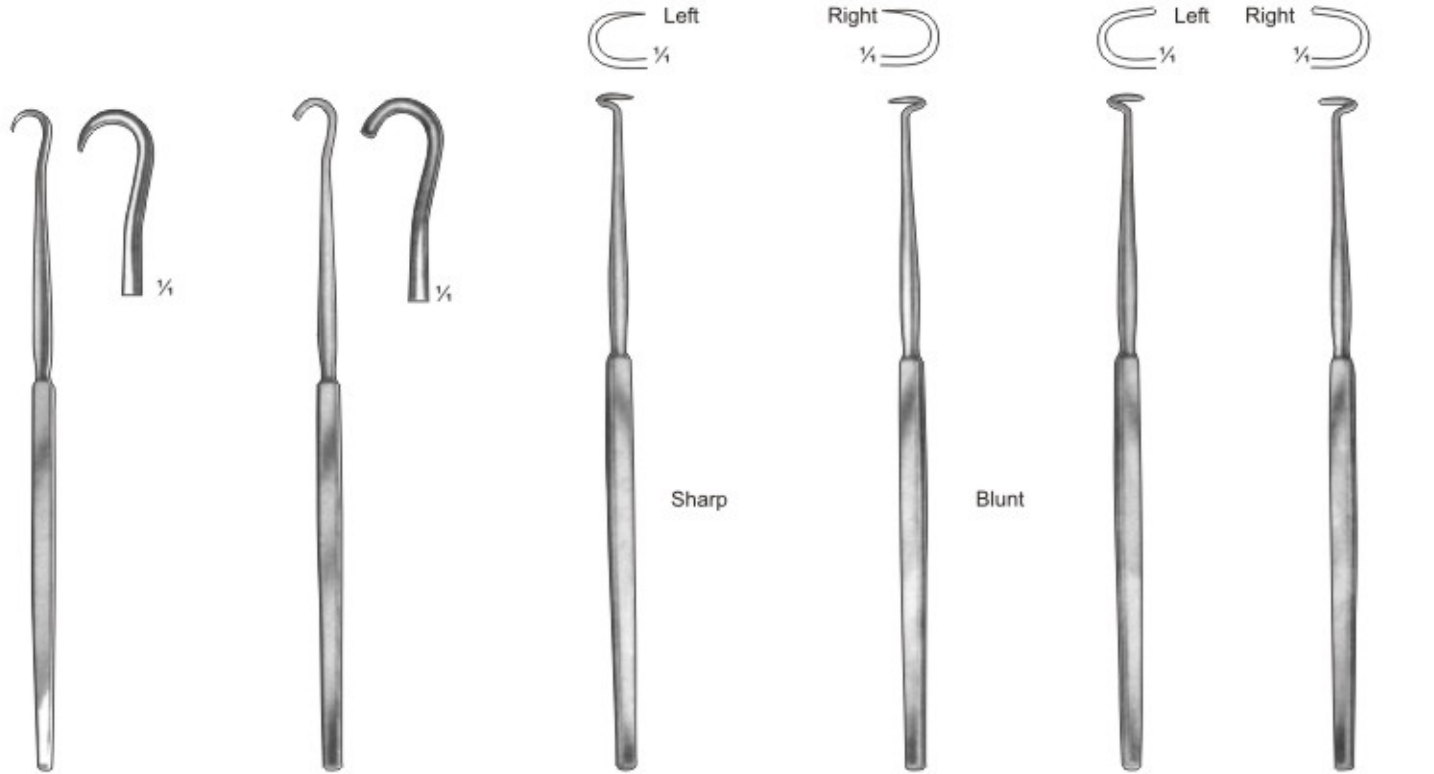

**ITERSON**  
19-064-160  
16 cm, 6 1/4"

**ITERSON**  
19-065-160  
16 cm, 6 1/4"

**BOSE**  
19-066-160  
16 cm, 6 1/4"

**BOSE**  
19-067-160  
16 cm, 6 1/4"

**BOSE**  
19-068-160  
16 cm, 6 1/4"

**BOSE**  
19-069-160  
16 cm, 6 1/4"

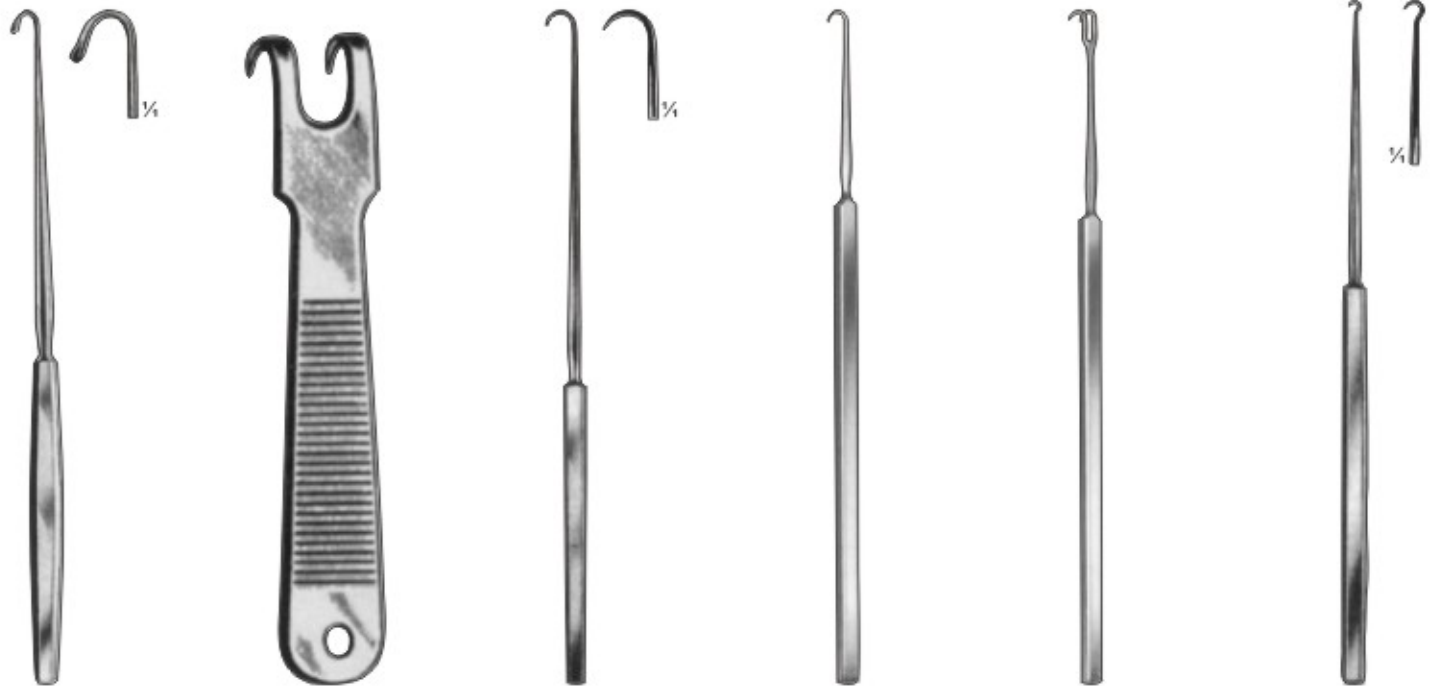

**LANGE**  
19-070-220  
22 cm, 8 3/4"  
Fistula hook

**KILNER**  
19-071-100  
10 cm, 4"  
sharp  
Skin hooks

**EMMET**  
19-072-220  
22 cm, 8 3/4"  
Fistula hook

**SIMON**  
19-073-220  
22 cm, 8 3/4"  
1 x sharp  
Fistula Hook

**SIMON**  
19-074-220  
22 cm, 8 3/4"  
2 x sharp

**HARTMANN**  
19-075-160  
16 cm, 6 1/4"  
sharp



## HOOKLET & SKIN HOOKS

Wundhäkchen, Mikrohäkchen  
Ganchito, Micro Ganchitos

Crochet, Micro crochetes  
Divaricatore, Micro Divaricatori



**GRAEFE**



**19-076-160**  
16 cm, 6 1/4"  
blunt



**19-077-160**  
16 cm, 6 1/4"  
sharp



**FOMON**  
**19-078-170**  
17 cm, 6 3/4"  
blunt



**CUSHING**  
**19-079-190**  
19 cm, 7 1/2" blunt  
**19-080-190**  
19 cm, 7 1/2" sharp  
Nerve-and  
vessel hook

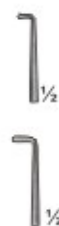

**CUSHING**  
**19-081-280**  
28 cm, 11" blunt  
**19-082-280**  
28 cm, 11" sharp  
Nerve-and  
vessel hook



**CUSHING**  
**19-083-190**  
19 cm, 7 1/2"



**FOMON**  
**19-084-160**  
16 cm, 6 1/4"  
blunt  
Choana hook



**COTTLE-  
NEIVERT**  
**19-085-200**  
20 cm, 8"  
blunt



**COTTLE**  
**19-086-150**  
15 cm, 6"  
Sharp



**COTTLE**  
**19-087-150**  
15 cm, 6"  
blunt/Sharp



**COTTLE**  
**19-088-150**  
15 cm, 6"  
sharp/blunt

# HOOKLETS, RETRACTORS



Wundhäkchen, Wundhaken  
Ganchito, Separadores

Crochet, Ecarteurs  
Divaricatore, Divaricatori

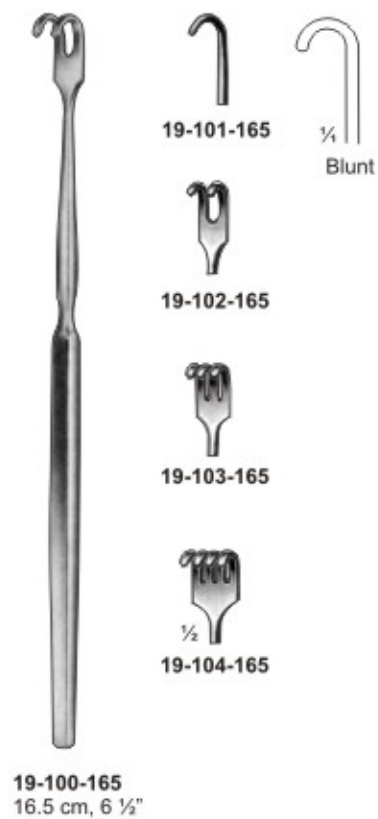
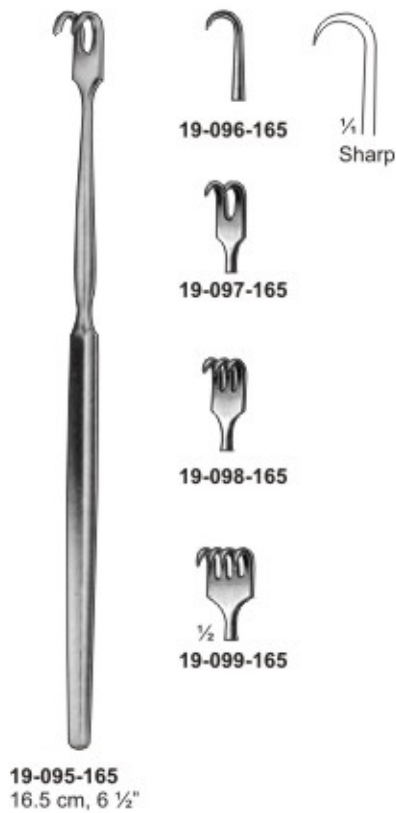





# HOOKLETS, RETRACTORS

Wundhäkchen, Wundhaken  
Ganchito, Separadores

Crochet, Ecarteurs  
Divaricatore, Divaricatori



**ROLLET**  
19-105-125  
12.5 cm, 4 3/4"



**ROLLET (Blair)**  
19-106-135  
13.5 cm, 5"



**PAUL**  
19-107-125  
12.5 cm, 4 3/4"



**19-108-160**  
16 cm, 6 1/4"



**19-109-135**  
13.5 cm, 5 1/4"

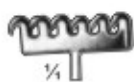

**MILLER**  
13.5 cm, 5 1/4"



Sharp  
**19-110-135**



Blunt  
**19-111-135**



**GROENHOLM**  
19-112-130  
13 cm, 5"



**BROM**  
19-113-170  
17 cm, 6 3/4"



**MOBERG**  
17 cm, 6 3/4"



14x5mm  
**19-114-170**

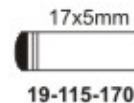

17x5mm  
**19-115-170**



25x6mm  
**19-116-170**

# HOOKLETS, RETRACTORS



Wundhäkchen, Wundhaken  
Ganchito, Separadores

Crochet, Ecarteurs  
Divaricatore, Divaricatori



Sharp



19-117-165



19-118-165



Blunt



19-121-165



19-122-165



19-119-165



19-120-165



19-123-165



19-124-165

16.5 cm, 6 1/2"

16.5 cm, 6 1/2"



16 cm, 6 1/4"  
flexible



19-125-160



19-126-160



19-127-160



19-128-160



19-129-160



19-130-160



16.5 cm, 6 1/2"  
flexible



19-131-165  
sharp



19-132-165  
blunt



## HOOKLETS, RETRACTORS

Wundhäkchen, Wundhaken  
Ganchito, Separadores

Crochet, Ecarteurs  
Divaricatore, Divaricatori

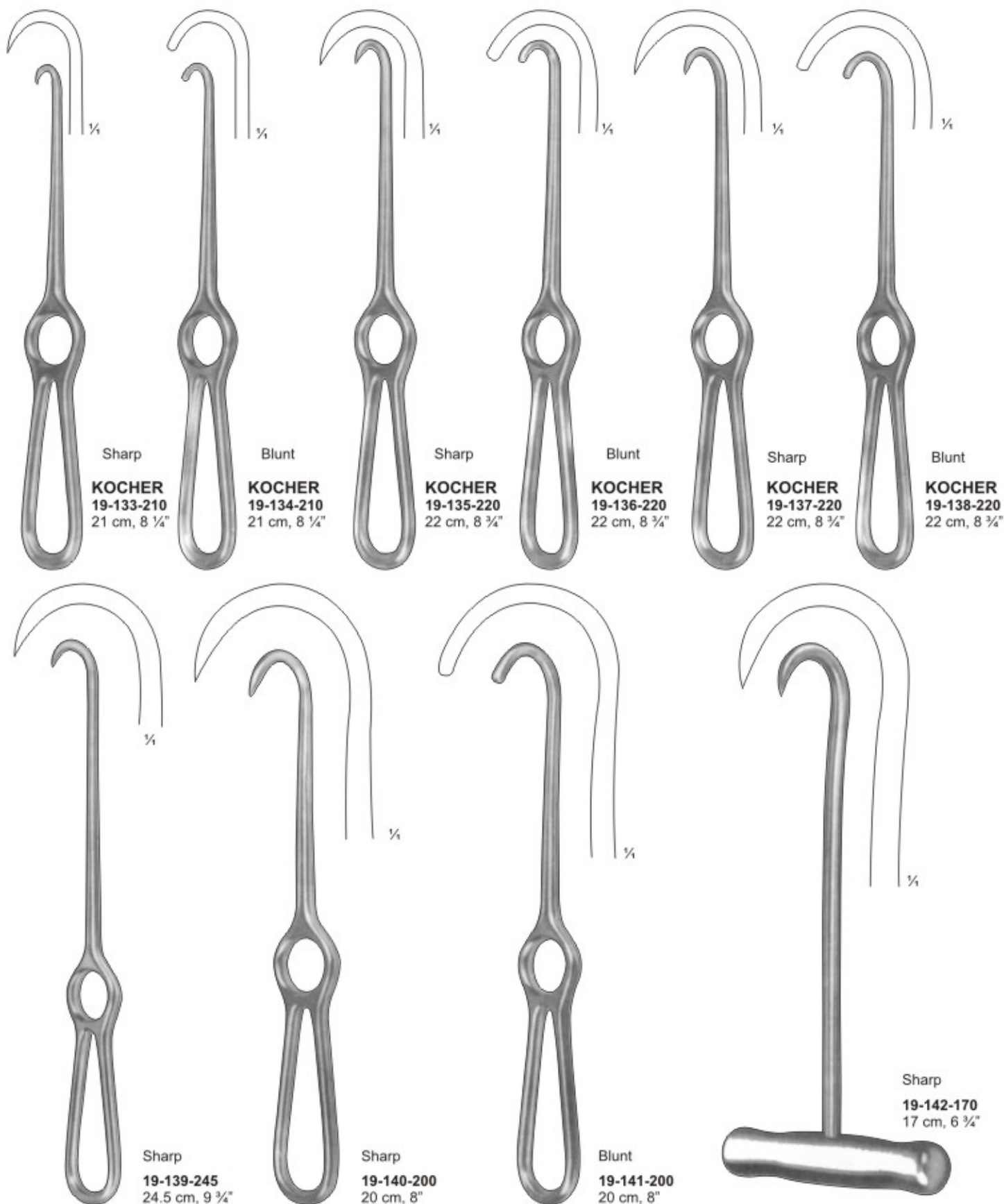

# HOOKLETS, RETRACTORS



Wundhäkchen, Wundhaken  
Ganchito, Separadores

Crochet, Ecarteurs  
Divaricatore, Divaricatori



**VOLKMANN**  
19-143-230  
23 cm, 9"



**VOLKMANN**  
19-144-230  
23 cm, 9"



**LAMBOTTE**  
20 cm 18"  
19-145-200  
13 x 235 mm  
19-146-200  
20 x 255 mm  
19-147-200  
27 x 270 mm



**VOLKMANN**  
11.5 cm, 4 1/2"



**MURPHY  
RETRACTORS**  
20 cm 18"  
19-156-200 2 prongs  
19-157-200 3 prongs  
19-158-200 4 prongs  
19-159-200 6 prongs  
Sharp/Blunt



## HOOKLETS, RETRACTORS

Wundhäkchen, Wundhaken  
Ganchito, Separadores

Crochet, Ecarteurs  
Divaricatore, Divaricatori



**19-160-160**  
10 x 6 mm  
16 cm, 6 1/4"

**19-162-160**  
20 x 6 mm  
16 cm, 6 1/4"

**LANGENBECK-  
MINI**



**19-161-160**  
17 x 5 mm  
16 cm, 6 1/4"

**19-163-160**  
22 x 8 mm  
16 cm, 6 1/4"

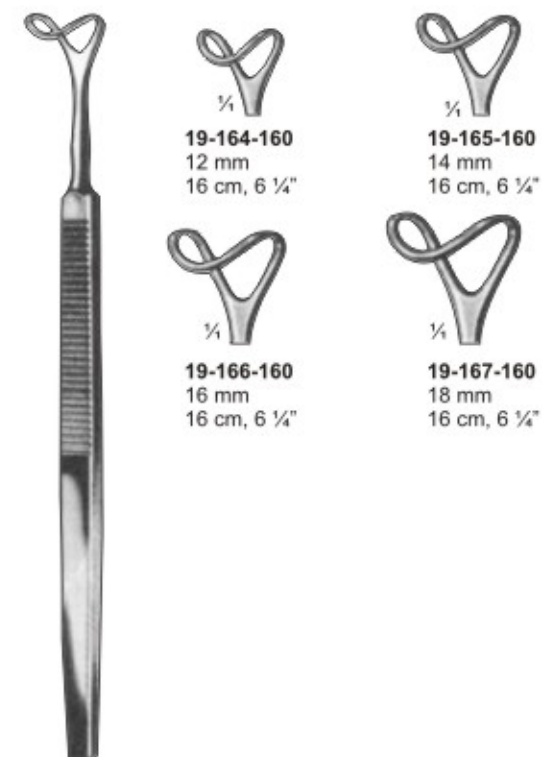

**19-164-160**  
12 mm  
16 cm, 6 1/4"

**19-165-160**  
14 mm  
16 cm, 6 1/4"

**19-166-160**  
16 mm  
16 cm, 6 1/4"

**19-167-160**  
18 mm  
16 cm, 6 1/4"

**RETRACTOR**



**NEIVERT**  
**19-168-160**  
16 cm, 6 1/4"



**LUKENS**  
**19-169-170**  
17 cm, 6 3/4"



**COPE**  
**19-170-180**  
18 cm, 7"

# RETRACTORS



Wundhaken  
Separadores

Ecarteurs  
Divaricatori



**SENN MALLOW  
RETRACTOR**  
19-171-160  
Blunt  
16 cm, 6 1/4"



**SENN MALLOW  
RETRACTOR**  
19-172-160  
Sharp  
16 cm, 6 1/4"

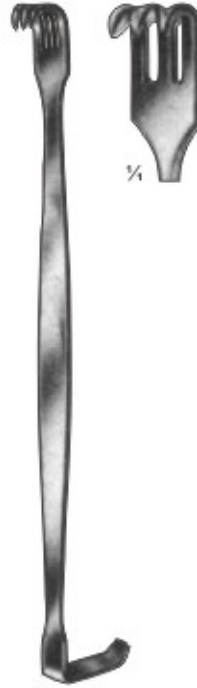

**BABY-SENN  
MUELLER**  
19-173-160  
7 x 8.5 mm  
16 cm, 6 1/4"  
sharp/blunt



**SENN-MUELLER**  
19-174-160  
18 x 6 mm  
16 cm, 6 1/4"  
sharp



**VOLKMAN  
RETRACTOR**  
19-175-220  
Sharp, 4 Prongs  
22 cm, 8 3/4"



**VOLKMAN  
RETRACTOR**  
19-176-220  
Blunt, 4 Prongs  
22 cm, 8 3/4"



**STERNBERG**  
19-177-120 12 cm, 4 3/4"  
19-178-140 14 cm, 5 1/2"  
19-179-160 16 cm, 6 1/4"

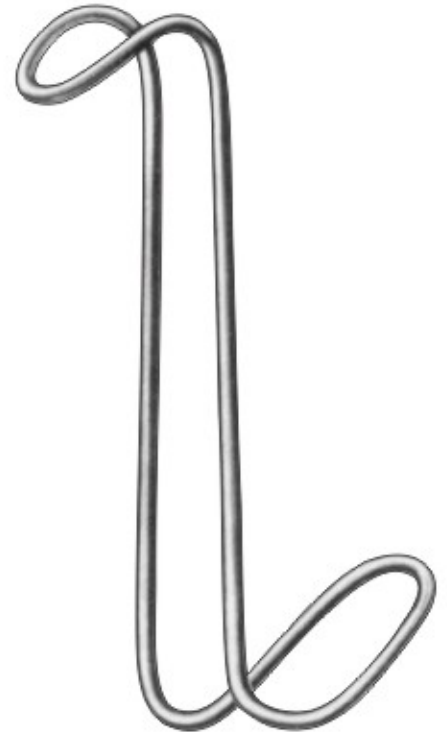

**COLLIN-HARTMANN**  
19-180-140  
38 x 28 / 32 x 21 mm 14 cm, 5 1/2"  
19-181-160  
52 x 34 / 36 x 27 mm 16 cm, 6 1/4"



# RETRACTORS

Wundhaken  
Separadores

Ecarteurs  
Divaricatori

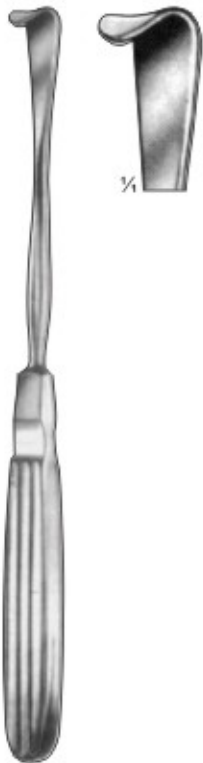

**HERZFELD**  
19-182-200  
20 cm, 8"



**STRANDELL-STILLE**  
19-183-190  
19 cm, 7 1/2"



**STRANDELL-STILLE**  
19-184-190  
19 cm, 7 1/2"

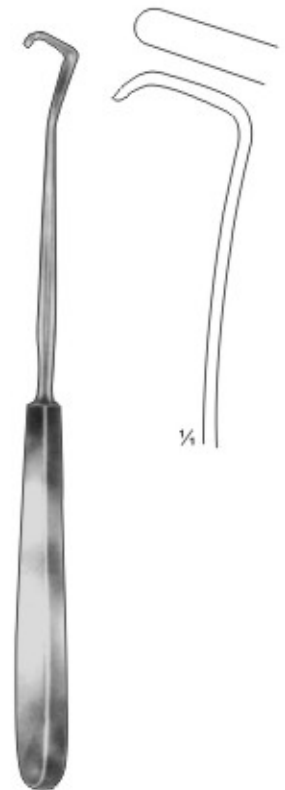

**SCHOENBORE**  
19-185-210  
21 cm, 8 1/4"



**KONIG**

**19-186-170**  
13 x 13 mm  
17 cm, 6 3/4"

**19-187-170**  
12 x 16 mm  
17 cm, 6 3/4"



**SENN-GREEN**

**19-188-150**  
10 x 6 mm  
15 cm, 6"

**19-189-150**  
20 x 6 mm  
15 cm, 6"



**COTTLE**  
19-190-150  
10 x 12 mm  
15 cm, 6"



**RAGNELL-DAVIS**  
19-191-140  
8 x 4 mm  
19-192-140  
15 x 5.5 mm  
14 cm, 5 1/2"

# RETRACTORS



Wundhaken  
Separadores

Ecarteurs  
Divaricatori

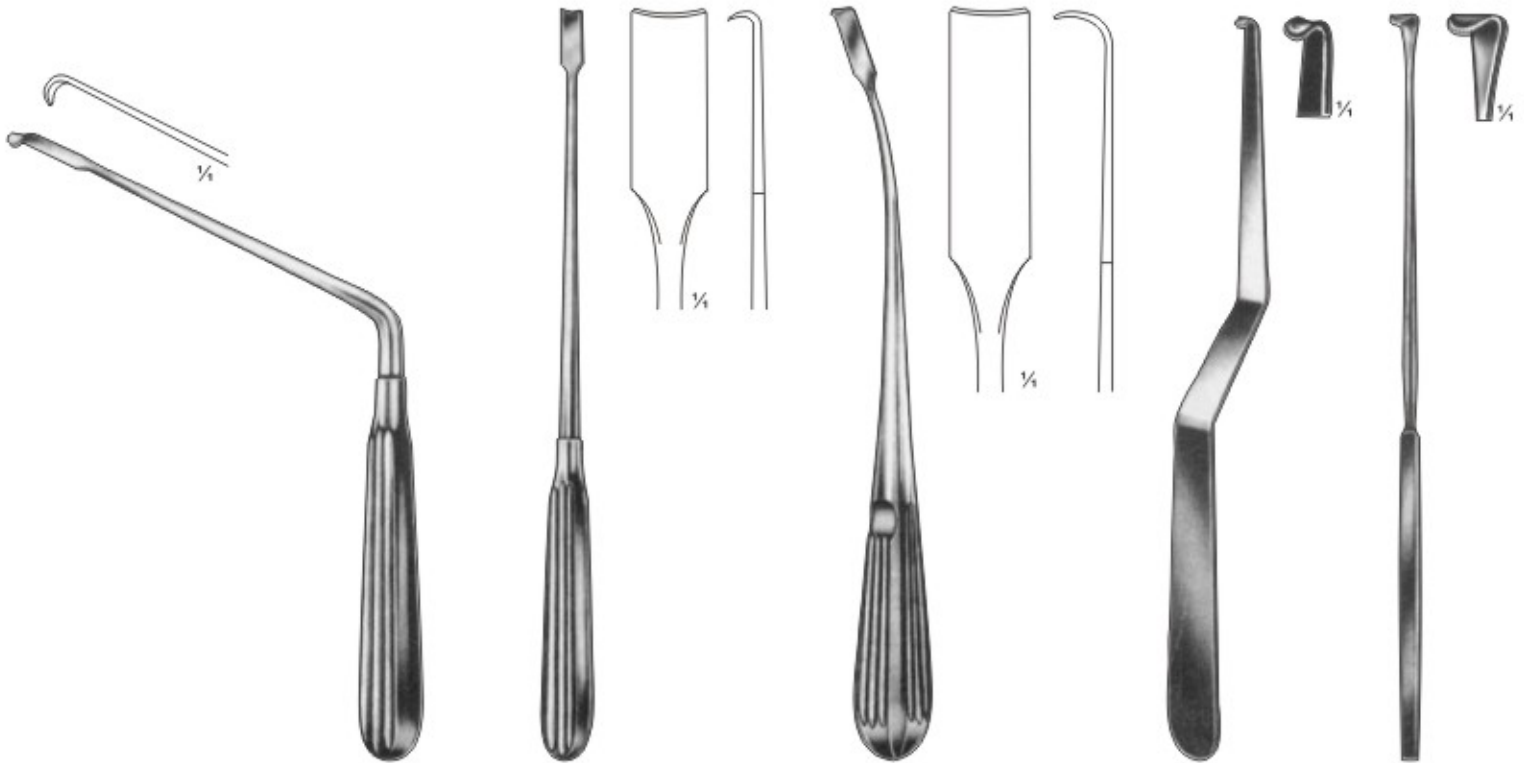

**SCOVILLE**  
19-193-200  
7 mm  
20 cm, 8"

**SCOVILLE**  
19-194-230  
8 mm  
23 cm, 9"

**HOLSHER**  
19-195-240  
7 mm  
24 cm, 9 1/2"

**LOVE**  
19-196-210  
4 mm  
21 cm, 8 1/2"

**LOVE**  
19-197-190  
19 cm, 7 1/2"

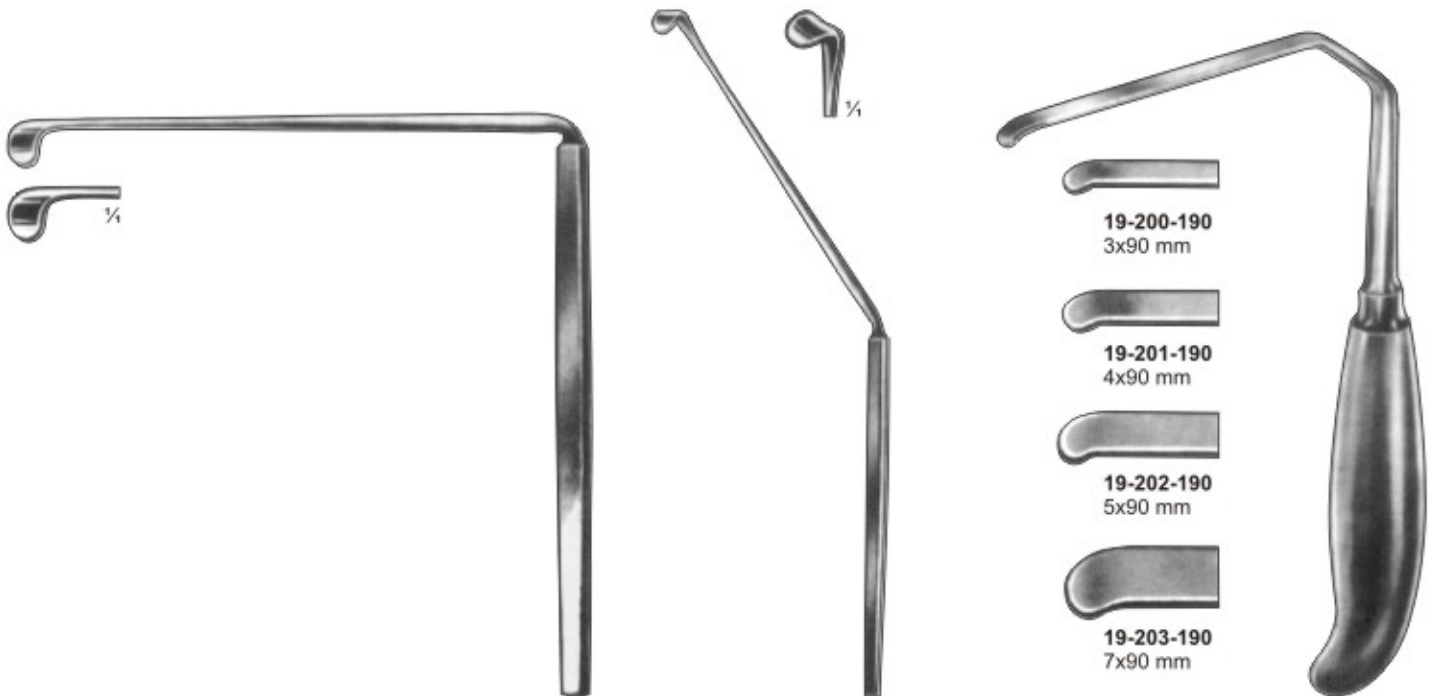

**LOVE**  
19-198-190  
19 cm, 7 1/2"

**LOVE**  
19-199-190  
19 cm, 7 1/2"

**19-200-190**  
3x90 mm

**19-201-190**  
4x90 mm

**19-202-190**  
5x90 mm

**19-203-190**  
7x90 mm

**HESS**  
19 cm, 7 1/2"





# HOOKLET

Wundhäkchen  
Ganchito

Crochet  
Divaricatore



**GIL-VERNET**  
24.5 cm, 9 3/4"



**GIL-VERNET**  
28 cm, 11"





Wundhäkchen  
Ganchito

Crochet  
Divaricatore

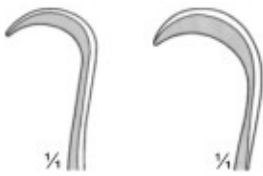
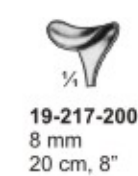

Fig. 1  
**19-214-155**  
12 x 12 mm  
15.5 cm, 6"

Fig. 2  
**19-215-155**  
12 x 14 mm  
15.5 cm, 6"



Fig. 3  
**19-216-155**  
12 x 16 mm  
15.5 cm, 6"



**19-217-200**  
8 mm  
20 cm, 8"



**19-218-200**  
10 mm  
20 cm, 8"



**19-219-200**  
12 mm  
20 cm, 8"



**19-220-200**  
14 mm  
20 cm, 8"



**19-221-200**  
16 mm  
20 cm, 8"



**19-222-200**  
18 mm  
20 cm, 8"



**19-223-240**  
8 mm  
24 cm, 9 1/2"



**19-224-240**  
10 mm  
24 cm, 9 1/2"



**19-225-240**  
12 mm  
24 cm, 9 1/2"



**19-226-240**  
14 mm  
24 cm, 9 1/2"



**19-227-240**  
16 mm  
24 cm, 9 1/2"



**19-228-240**  
18 mm  
24 cm, 9 1/2"

MANNERFELT

CUSHING

CUSHING



**19-229-240**  
11 x 14 mm  
24 cm, 9 1/2"



**19-230-240**  
13 x 18 mm  
24 cm, 9 1/2"



**19-231-240**  
15 x 22 mm  
24 cm, 9 1/2"



**19-232-180**  
10 x 10 mm  
18 cm, 7"



**19-233-160**  
7 x 8 mm  
16 cm, 6 1/4"

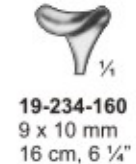

**19-234-160**  
9 x 10 mm  
16 cm, 6 1/4"



**19-235-160**  
9 x 12 mm  
16 cm, 6 1/4"



**19-236-160**  
11 x 14 mm  
16 cm, 6 1/4"



**19-237-160**  
13 x 16 mm  
16 cm, 6 1/4"



**19-238-160**  
13 x 18 mm  
16 cm, 6 1/4"

CUSHING

CUSHING-KOCHER

DESMARRES



# RETRACTORS

Wundhaken  
Separadores

Ecarteurs  
Divaricatori

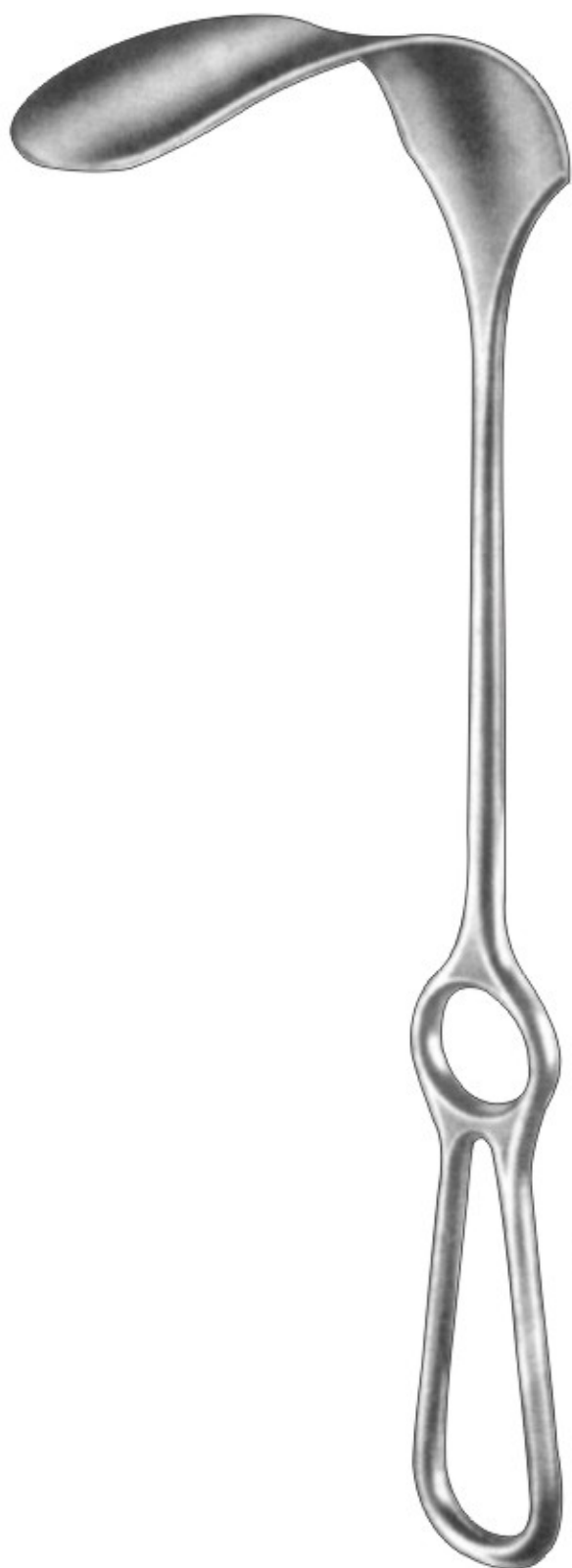

**KOCHER**  
28 cm 11"



19-239-280



19-240-280

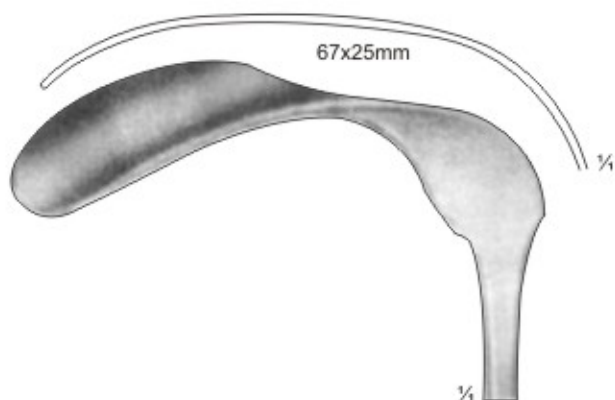

19-241-280

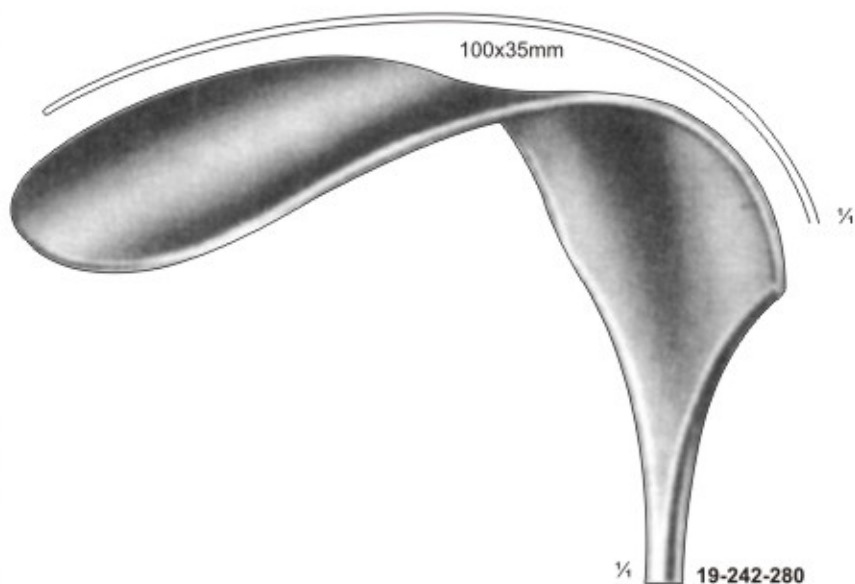

19-242-280

# RETRACTORS



Wundhaken  
Separadores

Ecarteurs  
Divaricatori

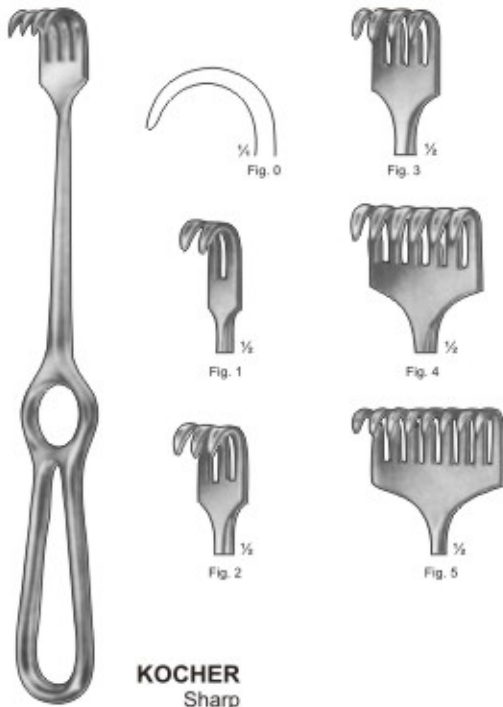

**KOCHER**  
Sharp

- 19-243-220 22 cm, 8 3/4" 15 x 10 mm Fig. 1
- 19-244-220 22 cm, 8 3/4" 15 x 15 mm Fig. 2
- 19-245-220 22 cm, 8 3/4" 15 x 20 mm Fig. 3
- 19-246-220 22 cm, 8 3/4" 15 x 30 mm Fig. 4
- 19-247-220 22 cm, 8 3/4" 15 x 40 mm Fig. 5

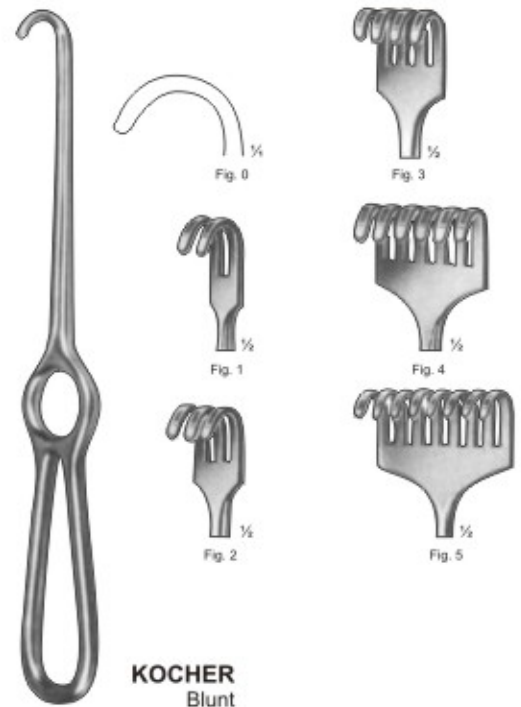

**KOCHER**  
Blunt

- 19-248-220 22 cm, 8 3/4" 15 x 10 mm Fig. 1
- 19-249-220 22 cm, 8 3/4" 15 x 15 mm Fig. 2
- 19-250-220 22 cm, 8 3/4" 15 x 20 mm Fig. 3
- 19-251-220 22 cm, 8 3/4" 15 x 30 mm Fig. 4
- 19-252-220 22 cm, 8 3/4" 15 x 40 mm Fig. 5



19-253-190  
19 x 12 mm

19-254-190  
21 x 15 mm

**KOCHER**  
19 cm, 7 1/2"

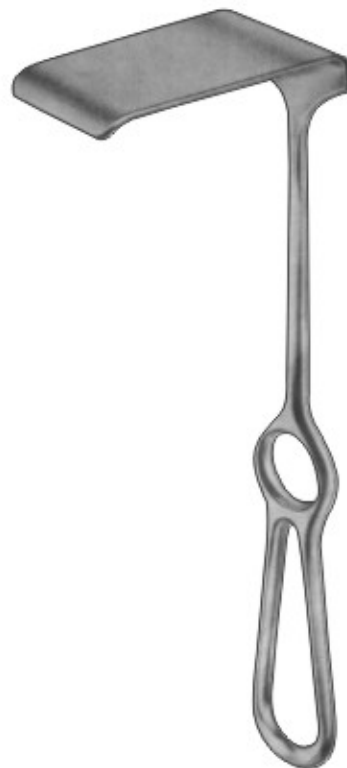

**KOCHER**  
23 cm, 9"

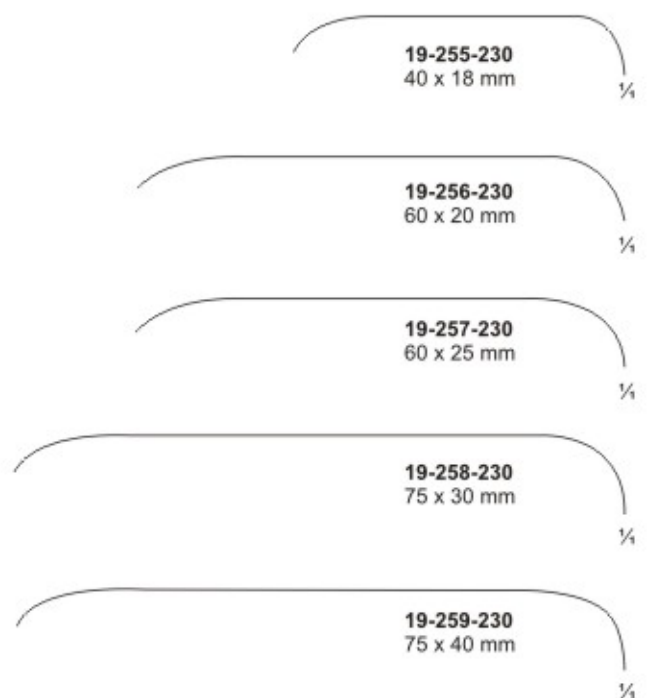

19-255-230  
40 x 18 mm

19-256-230  
60 x 20 mm

19-257-230  
60 x 25 mm

19-258-230  
75 x 30 mm

19-259-230  
75 x 40 mm



## RETRACTORS

Wundhaken  
Separadores

Ecarteurs  
Divaricatori



KOCHER-LANGENBECK



**19-260-215**  
25 x 6 mm  
21.5 cm, 8 1/2" 1/4



**19-261-215**  
35 x 8 mm  
21.5 cm, 8 1/2" 1/4



**19-262-215**  
35 x 11 mm  
21.5 cm, 8 1/2" 1/4



**19-263-215**  
35 x 15 mm  
21.5 cm, 8 1/2" 1/4



**19-264-215**  
40 x 11 mm  
21.5 cm, 8 1/2" 1/4

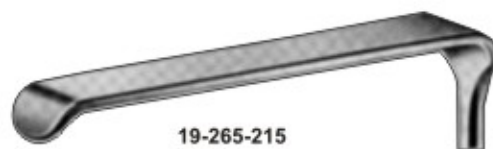

**19-265-215**  
55 x 11 mm  
21.5 cm, 8 1/2" 1/4



**19-266-215**  
70 x 14 mm  
21.5 cm, 8 1/2" 1/4



**19-267-215**  
80 x 12 mm  
21.5 cm, 8 1/2" 1/4

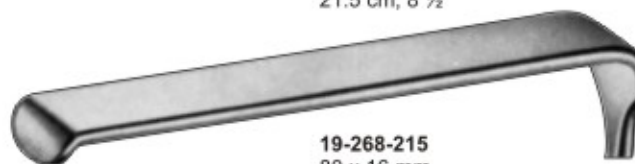

**19-268-215**  
80 x 16 mm  
21.5 cm, 8 1/2" 1/4



Wundhaken  
Separadores

Ecarteurs  
Divaricatori



**KOCHER**  
**19-269-220** 40 x 10 mm  
 22 cm, 8 3/4"  
**19-270-220** 40 x 15 mm  
 22 cm, 8 3/4"  
**19-271-220** 40 x 20 mm  
 22 cm, 8 1/2"



**KOCHER**  
**19-272-225**  
 70 x 25 mm  
 22.5 cm 8 3/4"



**KOCHER**  
**19-273-230** 23 cm, 9" 35 x 18 mm  
**19-274-230** 23 cm, 9" 60 x 20 mm  
**19-275-230** 23 cm, 9" 60 x 25 mm  
**19-276-230** 23 cm, 9" 75 x 30 mm  
**19-277-230** 23 cm, 9" 75 x 40 mm



**KOCHER**  
**19-278-250** 25 cm, 9 3/4" 80 x 45 mm  
**19-279-250** 25 cm, 9 3/4" 80 x 55 mm  
**19-280-250** 25 cm, 9 3/4" 80 x 65 mm



**KOCHER-  
WAGNER**





# RETRACTORS

Wundhaken  
Separadores

Ecarteurs  
Divaricatori



**LANGENBECK**  
**19-284-215**  
21.5 cm 8 1/2"  
Handle vertical  
to the blade



**LANGENBECK**  
20 cm, 8"



**19-285-200**  
20 x 7 mm  
20 cm, 8"



**19-286-200**  
30 x 7 mm  
20 cm, 8"



**19-287-200**  
30 x 11 mm  
20 cm, 8"



**19-288-200**  
30 x 15 mm  
20 cm, 8"



**19-289-200**  
30 x 20 mm  
20 cm, 8"



**19-290-200**  
44 x 10 mm  
20 cm, 8"



**19-291-200**  
44 x 15 mm  
20 cm, 8"



**19-292-200**  
45 x 20 mm  
20 cm, 8"



**19-293-200**  
50 x 20 mm  
20 cm, 8"

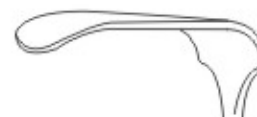

**19-294-200**  
60 x 20 mm  
20 cm, 8"



**LANGENBECK**  
**19-295-210**  
21 cm 8 1/4"  
38 x 9mm



**LANGENBECK**  
24 cm, 8 1/4"



**19-296-240**  
35 x 7mm



**19-297-240**  
35 x 11mm



**19-298-240**  
35 x 15mm

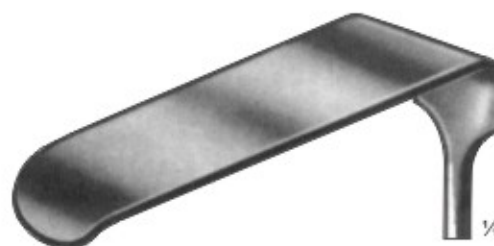

**19-299-240**  
35 x 20mm

# RETRACTORS



Wundhaken  
Separadores

Ecarteurs  
Divaricatori



**KNEE RETRACTOR**  
19-300-225  
22.5 cm 8 1/4"  
37 x 9 mm



**LANGENBECK**  
19-301-210  
21 cm 8 1/4"  
85 x 15 mm  
Handle vertical to blade

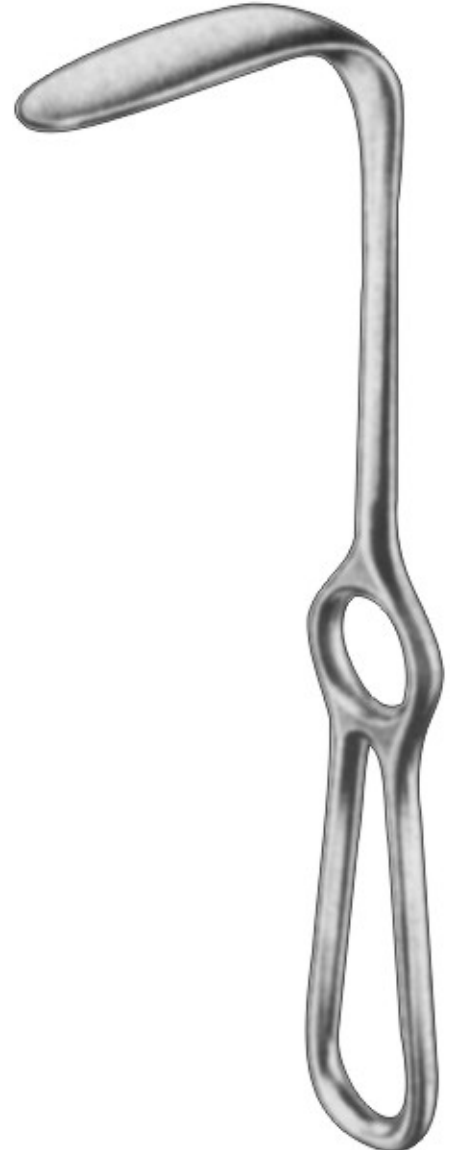

**LANGENBECK**  
19-302-210  
21 cm, 8 1/4"  
53 x 20 mm  
19-303-210  
21 cm, 8 1/4"  
61 x 20 mm





# RETRACTORS

Wundhaken  
Separadores

Ecarteurs  
Divaricatori



**LANGENBECK**  
315-605-220  
22 cm, 8 1/2"



**19-304-220**  
25 x 6 mm

**19-312-220**  
25 x 6 mm



**19-305-220**  
35 x 8 mm

**19-313-220**  
35 x 8 mm



**19-306-220**  
35 x 11 mm

**19-314-220**  
35 x 11 mm



**19-307-220**  
35 x 15 mm

**19-315-220**  
35 x 15 mm



**19-308-220**  
41 x 11 mm

**19-316-220**  
41 x 11 mm



**19-309-220**  
55 x 11 mm

**19-317-220**  
55 x 11 mm



**19-310-220**  
70 x 14 mm

**19-318-220**  
70 x 14 mm



**LANGENBECK**  
19-319-220  
22 cm, 8 1/2"



Wundhaken  
Separadores

Ecarteurs  
Divaricatori





# RETRACTORS

Wundhaken  
Separadores

Ecarteurs  
Divaricatori



**19-323-210**  
14 x 17 mm  
21 cm, 8 1/4"



**19-324-210**  
20 x 22 mm  
21 cm, 8 1/4"



**19-325-210**  
26 x 30 mm  
21 cm, 8 1/4"

**MIDDELDORPF**



**19-326-210**  
40 x 12 mm  
21 cm, 8 1/4"



**19-327-210**  
55 x 14 mm  
21 cm, 8 1/4"

**CASPAR**



25 mm

**OLLIER**  
**19-328-185**  
18.5 cm, 7 1/4"



**LAHEY GOITER RETRACTOR**  
**19-329-203** 20.3 cm, 8"  
Right angle blade, length  
1 inch (2.5cm). With lip.



28x6 mm

**LAHEY**  
**315-630-190**  
19 cm, 7 1/2"

# RETRACTORS



Wundhaken  
Separadores

Ecarteurs  
Divaricatori



**315-631-215** 14 x 17 mm  
21.5 cm, 8 1/2"



**315-634-215** 14 x 17 mm  
21.5 cm, 8 1/2"

**315-632-220** 20 x 22 mm  
22 cm, 8 3/4"



**315-635-220** 20 x 22 mm  
22 cm, 8 3/4"

**315-633-235** 26 x 30 mm  
23.5 cm, 9 1/4"



**315-636-235** 26 x 30 mm  
23.5 cm, 9 1/4"



**MIDDELDORPF**

**MIDDELDORPF**



**MIDDELDORPF**  
**315-637-255** 45 x 45 mm  
25.5 cm, 10"



**315-638-255** 45 x 50 mm  
25.5 cm, 10"



**315-639-255** 55 x 70 mm  
25.5 cm, 10"



**GREEN**  
22 cm, 8 3/4"



# RETRACTORS

Wundhaken  
Separadores

Ecarteurs  
Divaricatori



**19-341-170**  
17 cm, 6 3/4"  
15 x 6 mm  
Fig. 1  
blunt

**19-342-170**  
17 cm, 6 3/4"  
15 x 6 mm  
Fig. 2  
toothed

**STRANDELL-  
STILLE**



**SCHOENBORN**  
**19-343-210**  
21 cm, 8 1/4"



**TENDON HOOKS**  
**19-344-175** 17.5 cm, 7"  
**19-345-175** 17.5 cm, 7"  
12 x 6 mm Fig. 1  
12 x 11 mm Fig. 2



**KLAPP**  
**19-346-175**  
15 x 11 mm  
17.5 cm, 7"



**WASSMUND**  
**19-347-200**  
20 cm, 8"  
33 x 20mm



**LITTLE**  
**19-348-200**  
20 cm, 8"  
12x14 mm

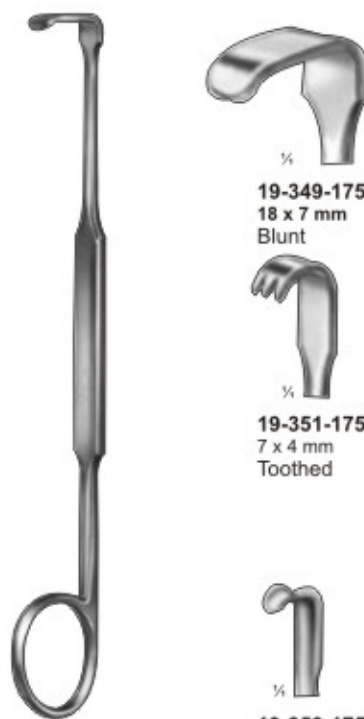

**MEYERDING**  
18 cm, 7"



**19-349-175**  
18 x 7 mm  
Blunt



**19-351-175**  
7 x 4 mm  
Toothed



**19-353-175**  
7 x 4 mm  
Saddle Shaped



**19-350-175**  
16 x 5 mm  
Toothed



**19-352-175**  
10 x 3 mm  
Blunt



**19-354-175**  
10 x 4 mm  
Sharp

# RETRACTORS



Wundhaken  
Separadores

Ecarteurs  
Divaricatori

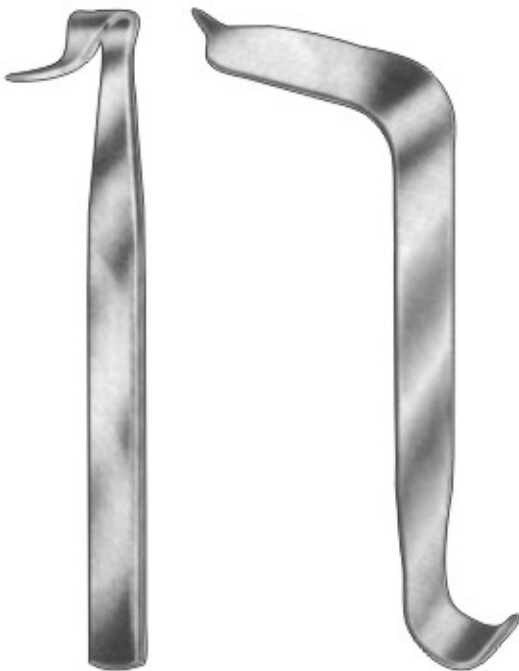

**BLOUNT**  
19-355-175  
17.5 cm, 6 3/4"  
42 x 4 mm



**TAYLOR**  
Spinal Retractors  
19-356-165 16.5 cm, 6 1/2"  
75 x 30 mm  
19-357-165 16.5 cm, 6 1/2"  
100 x 30 mm



**LUER**  
19-358-110 11 cm, 4 1/4"  
10 x 8 mm  
19-359-110 11 cm, 4 1/4"  
12 x 11 mm



**ROSE**  
19-360-130 13 cm, 5"  
12 x 12 mm  
12 x 15 mm



**CRILE**  
19-361-110 11 cm, 4 1/4"  
12 x 4 mm  
20 x 6 mm



**MATHIEU**  
Set 2 pcs.  
19-362-200 20 cm, 8"  
47 x 13 / 46 x 26 mm  
19-363-200 20 cm, 8"  
42 x 13 / 42 x 26 mm



**US-ARMY**  
Set 2 pcs.  
19-364-215 21.5 cm, 8 1/2"  
28 x 15 / 42 x 15 mm  
19-365-215 21.5 cm, 8 1/2"  
25 x 15 / 38 x 15 mm



**RICHARDSON EASTMAN**  
19-366-260  
26 cm, 10 1/4"  
small



**RICHARDSON EASTMAN**  
19-367-280  
28 cm, 11"

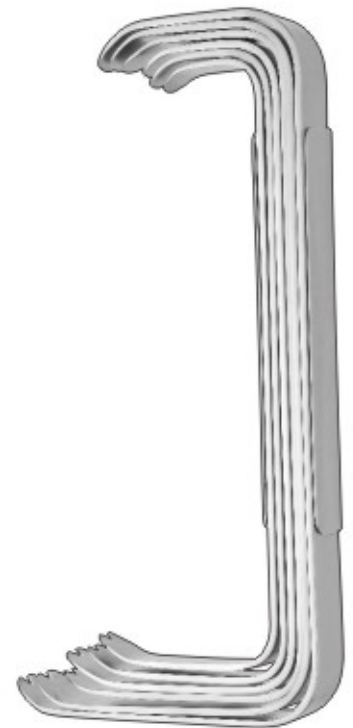

**USA RETRACTORS**  
19-368-001  
set of 6 pec.



# RETRACTORS

Wundhaken  
Separadores

Ecarteurs  
Divaricatori

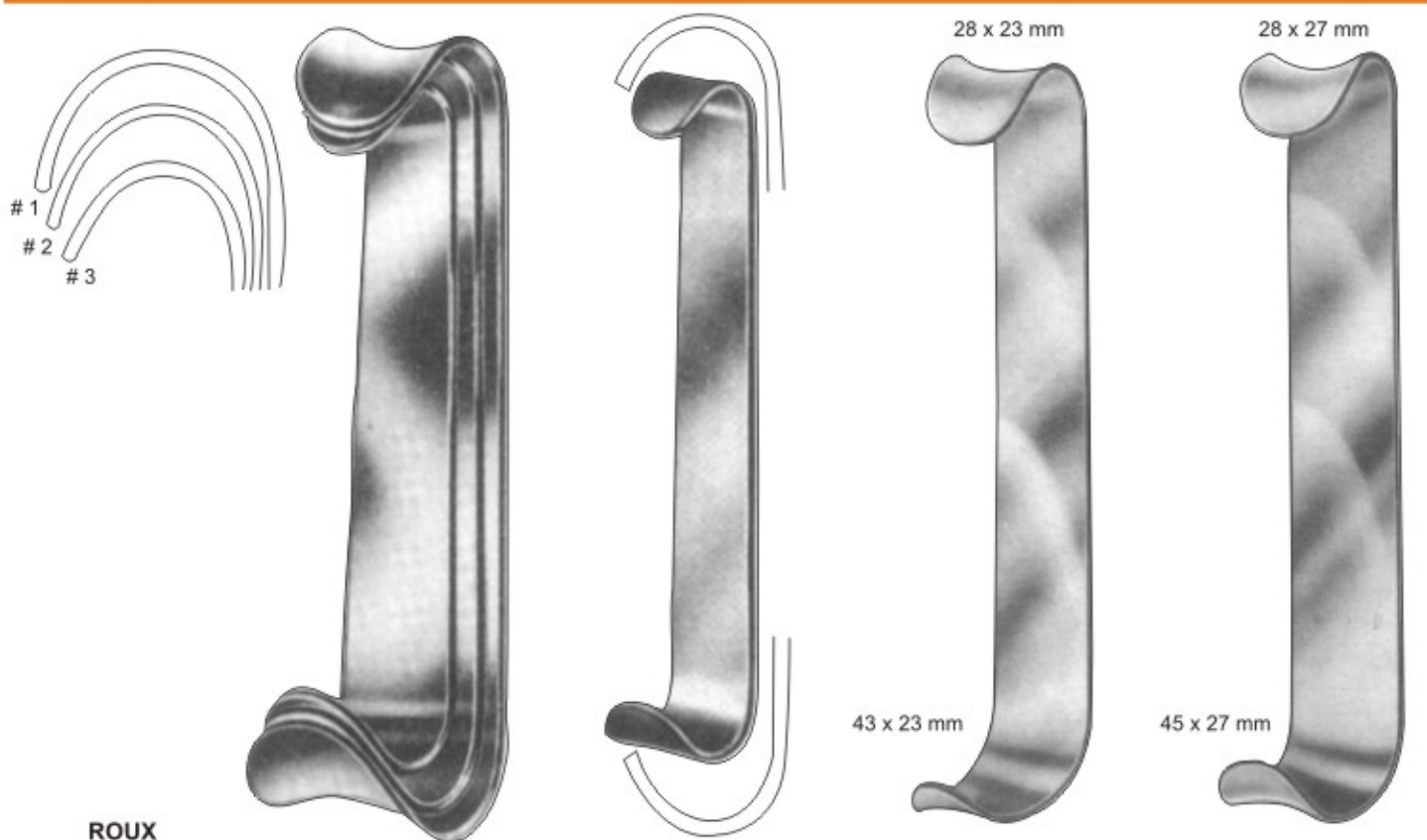

### ROUX

Set 3 pcs. consisting of

- # 1 19-369-140 14 cm, 5 1/2" 24 x 20 / 30 x 28 mm
- # 2 19-370-150 15 cm, 6" 29 x 26 / 36 x 36 mm
- # 3 19-371-170 17 cm, 6 3/4" 33 x 29 / 38 x 43 mm

### BABY-ROUX

- 19-372-130 13 cm, 5"  
15 x 15 mm  
18 x 21 mm

### ROUX

- 19-373-165  
16.5 cm, 6 1/2"

### ROUX

- 19-374-185  
18.5 cm, 7 1/4"

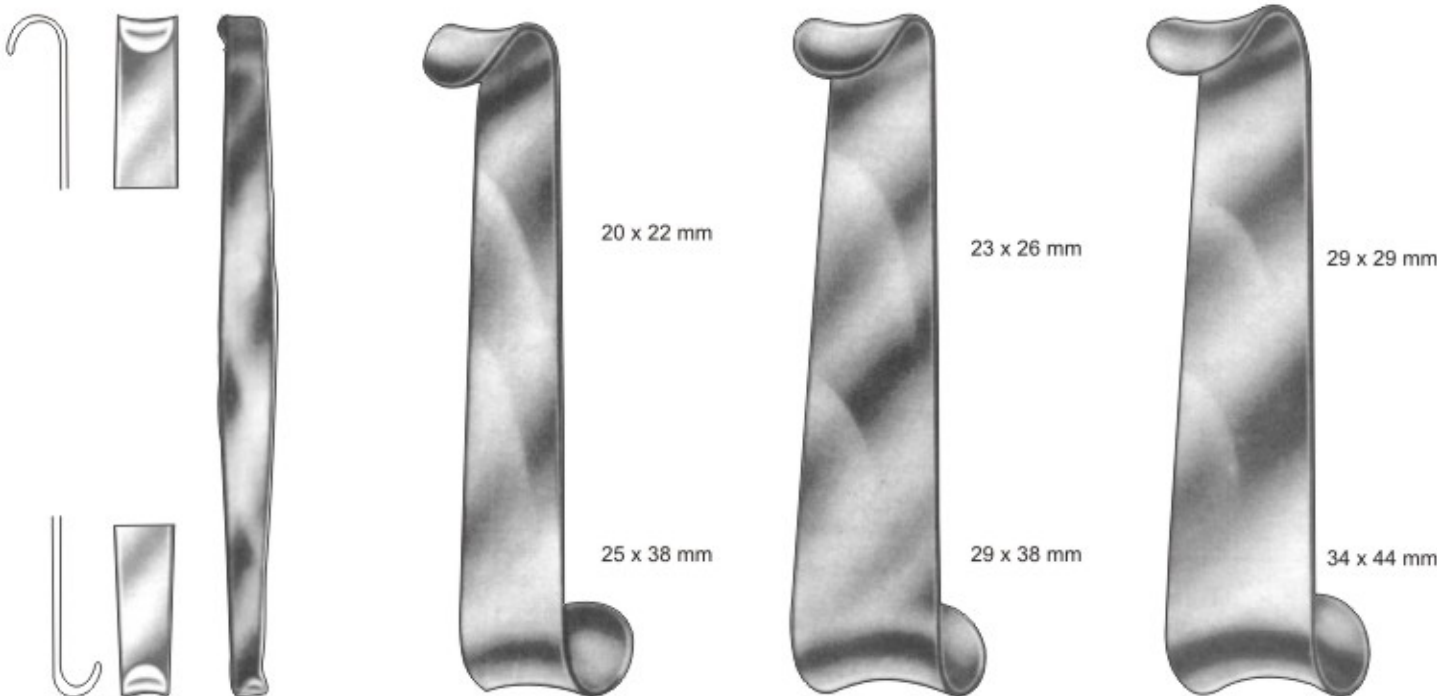

### MINI-ROUX

- 19-375-140  
14 cm, 5 1/2"

### ROUX-MAGNUS

- 19-376-150  
15 cm, 6"

### ROUX-MAGNUS

- 19-377-160  
16 cm, 6 1/4"

### ROUX-MAGNUS

- 19-378-170  
17 cm, 6 3/4"

# RETRACTORS



Wundhaken  
Separadores

Ecarteurs  
Divaricatori



## FARABEUF

Set 2 Pcs.

19-379-130 13 cm, 5"  
30 x 10 / 34 x 13 mm  
19-380-130 13 cm, 5"  
26 x 10 / 30 x 13 mm



## FARABEUF

Set 2 Pcs.

19-381-150 15 cm, 6"  
27 x 16 / 30 x 16 mm  
19-382-150 15 cm, 6"  
23 x 16 / 26 x 16 mm



## PARKER

Set 2 pcs.

19-383-135 13.5 cm, 5 1/4"  
22 x 15 mm / 22 x 15 mm



## PARKER

19-384-135 13.5 cm, 5 1/4"  
18 x 15 mm / 19 x 15 mm



## COLLIN

Set 2 pcs.

19-385-165 16.5 cm, 6 1/2"  
25 x 12 / 35 x 16 mm  
19-386-165 16.5 cm, 6 1/2"  
20 x 12 / 30 x 16 mm



## MAYO-COLLIN

Set 2 pcs.

19-387-150 15 cm, 6"  
28 x 18 / 25 x 18 mm



## PARKER-LANGENBECK

Set of 2 Pcs.

19-388-215 21.5 cm, 8 1/2" 25 x 15 mm fig. 2  
19-389-215 21.5 cm, 8 1/2" 21 x 15 mm fig. 1  
19-390-215 21.5 cm, 8 1/2" 40 x 15 mm fig. 1  
19-391-215 21.5 cm, 8 1/2" 46 x 15 mm fig. 2



## PARKER-MOTT

19-392-160

16 cm 6 1/4"  
68 x 24 / 74 x 24 mm





# RETRACTORS

Wundhaken  
Separadores

Ecarteurs  
Divaricatori



- 19-393-222**  
Blunt, 2 prongs.
- 19-394-222**  
Blunt, 3 prongs.
- 19-395-222**  
Blunt, 4 prongs.
- 19-396-222**  
Blunt, 5 prongs.
- 19-397-222**  
Blunt, 6 prongs.
  
- 19-398-222**  
Sharp, 2 prongs.
- 19-399-222**  
Sharp, 3 prongs.
- 19-400-222**  
Sharp, 4 prongs.
- 19-401-222**  
Sharp, 5 prongs.
- 19-402-222**  
Sharp, 6 prongs.

**VOLKMANN  
RETRACTORS**  
Long Pattern  
22.2 cm

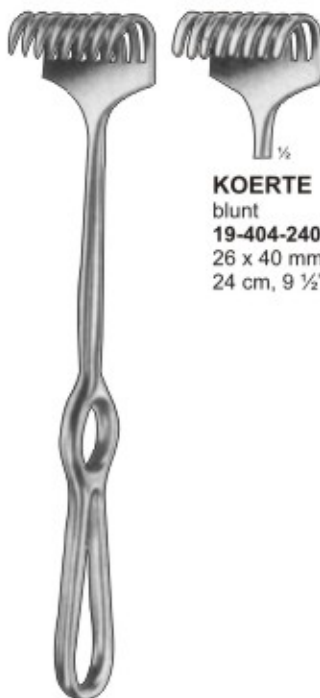

**KOERTE**  
blunt  
**19-404-240**  
26 x 40 mm  
24 cm, 9 1/2"

**KOERTE**  
sharp  
**19-403-240**  
26 x 40 mm  
24 cm, 9 1/2"



**KOERTE**  
blunt  
**19-405-230**  
46 x 55 mm  
23 cm, 9"



**KOERTE**  
semi-sharp  
**19-406-280**  
25 x 40 mm  
28 cm, 11"



**KOERTE**  
**19-407-230**  
23 cm, 9"  
Blunt



**KORTE-  
WAGNER**  
**19-408-280**  
28 cm, 11"  
blunt

# RETRACTORS



Wundhaken  
Separadores

Ecarteurs  
Divaricatori



VOLKMANN

## Sharp

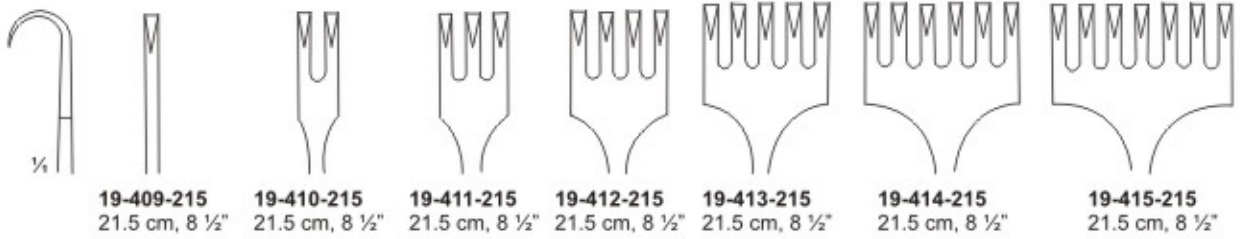

## Blunt

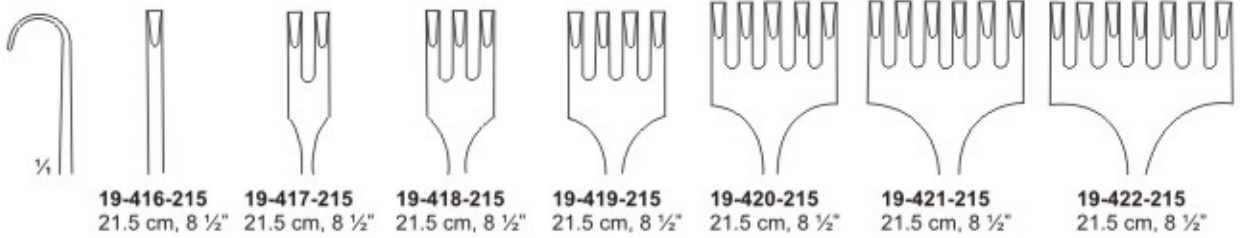

## Sharp

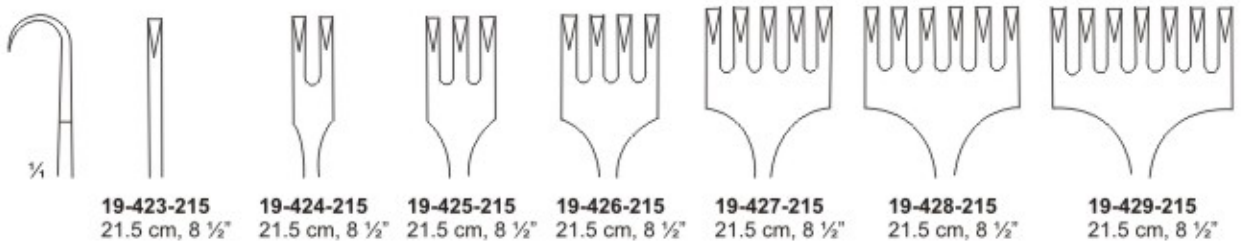

## Blunt

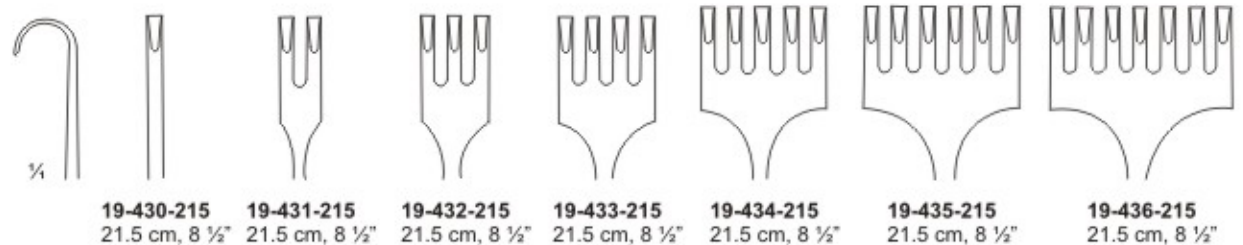

VOLKMANN



# RETRACTORS

Wundhaken  
Separadores

Ecarteurs  
Divaricatori

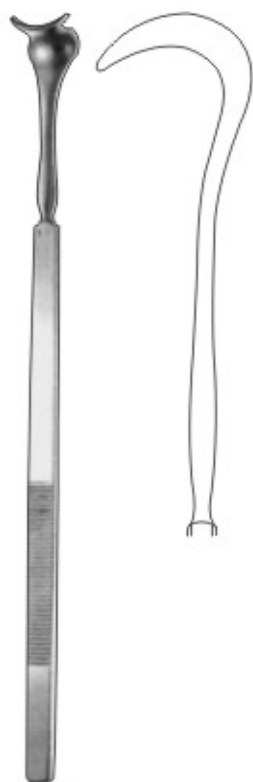

**GIL-VERNET**  
24 cm, 9 1/2"



**19-437-240**  
9 mm  
24 cm, 9 1/2"



**19-438-240**  
11 mm  
24 cm, 9 1/2"



**19-439-240**  
13 mm  
24 cm, 9 1/2"



**19-440-240**  
15 mm  
24 cm, 9 1/2"



**19-441-240**  
18 mm  
24 cm, 9 1/2"



**SAUERBRUCH**



**19-442-250**  
45 x 15 mm  
25 cm, 9 3/4"



**19-443-250**  
60 x 23 mm  
25 cm, 9 3/4"



**19-444-250**  
75 x 20 mm  
25 cm, 9 3/4"

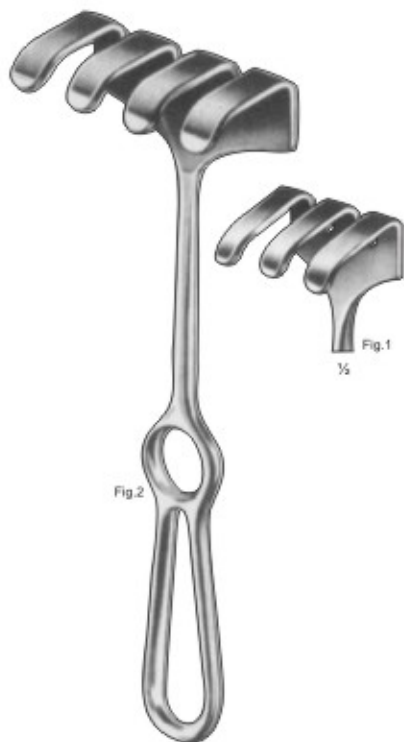

**OLLIER**  
blunt

**19-445-230** 23 cm, 9" 36 x 30 mm Fig.1  
**19-446-230** 23 cm, 9" 36 x 60 mm Fig.2



**ISRAEL**  
blunt

**19-447-225**  
22.5 cm, 8 3/4"  
Blunt



**ISRAEL**  
blunt

**19-448-250** 25 cm, 9 3/4" 40 x 40 mm Fig. 1  
**19-449-250** 25 cm, 9 3/4" 45 x 50 mm Fig. 2  
**19-450-250** 25 cm, 9 3/4" 50 x 60 mm Fig. 3  
**19-451-250** 25 cm, 9 3/4" 70 x 70 mm Fig. 4



Fig.1 1/2



Fig.2 1/2



Fig.3 1/2



Fig.4 1/2

# RETRACTORS



Wundhaken  
Separadores

Ecarteurs  
Divaricatori

19-452-225  
115 x 65 mm

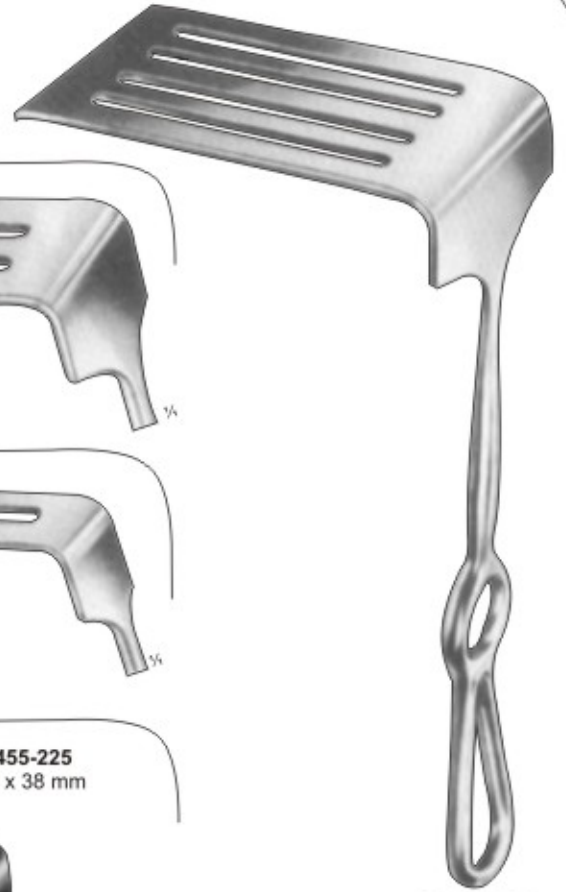

19-453-225  
115 x 38 mm



19-454-225  
82 x 22 mm



19-455-225  
130 x 38 mm

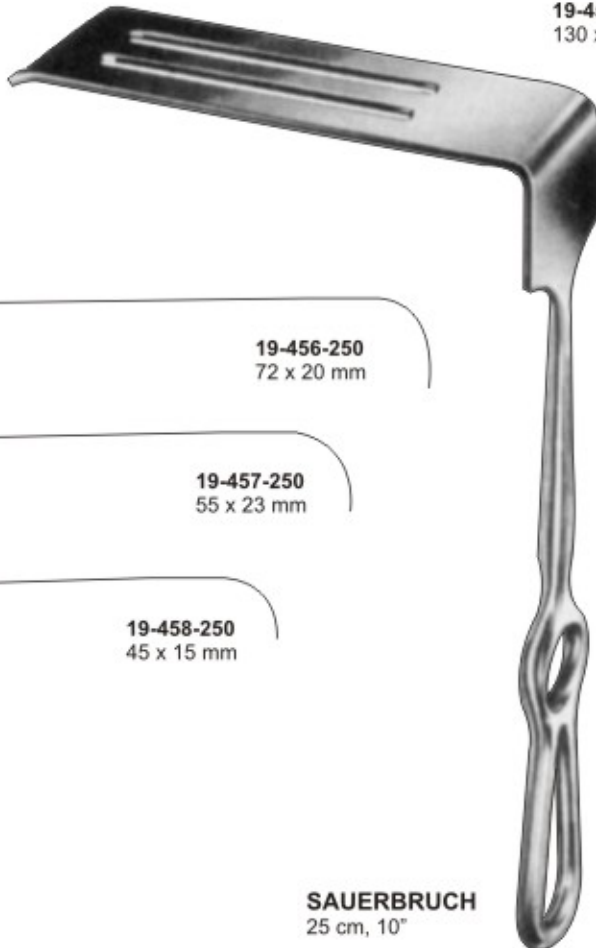

**CORYLLOS**  
22.5 cm, 8 3/4"

19-456-250  
72 x 20 mm

19-457-250  
55 x 23 mm

19-458-250  
45 x 15 mm

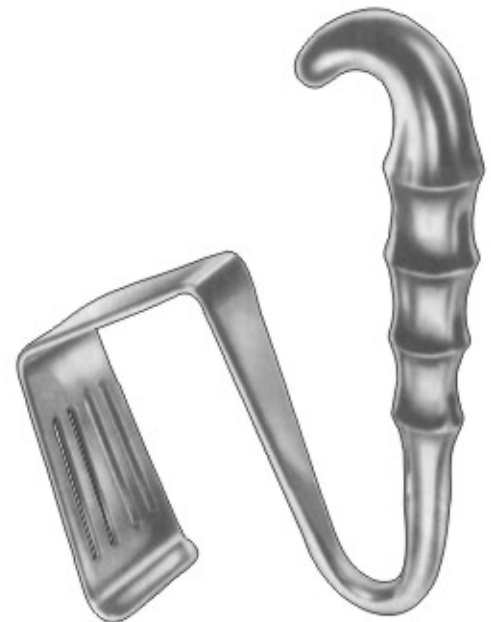

**SAUERBRUCH**  
25 cm, 10"

**DAVIDSON**  
19-459-160 16 cm, 6 1/4" 75 x 50 mm  
19-460-160 16 cm, 6 1/4" 75 x 90 mm



## RETRACTORS

Wundhaken  
Separadores

Ecarteurs  
Divaricatori

19-461-250  
180 x 30 mm

19-462-250  
160 x 30 mm

19-463-250  
140 x 30 mm

19-464-250  
130 x 30 mm

19-465-250  
120 x 25 mm

19-466-250  
100 x 25 mm

19-467-250  
80 x 20 mm



**BRUNER**  
25 cm, 10"

# RETRACTORS



Wundhaken  
Separadores

Ecarteurs  
Divaricatori

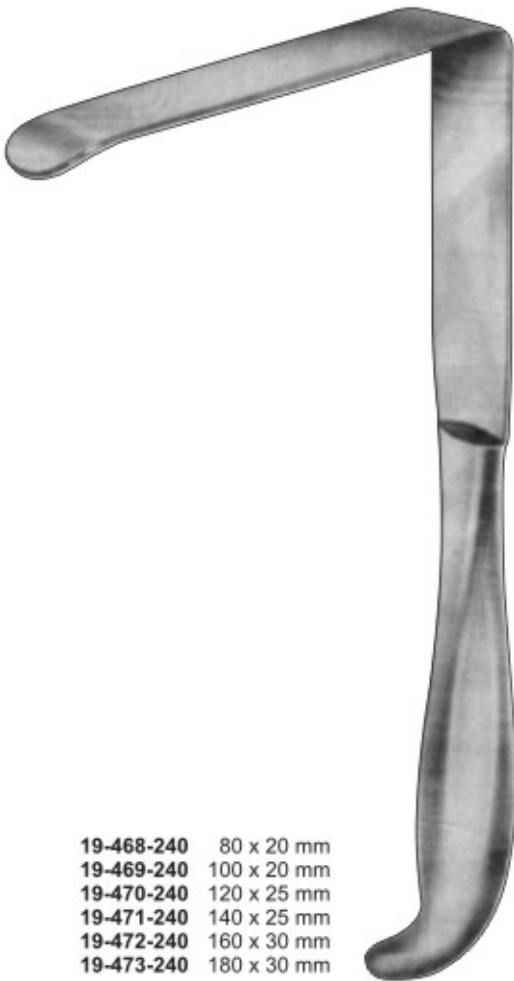
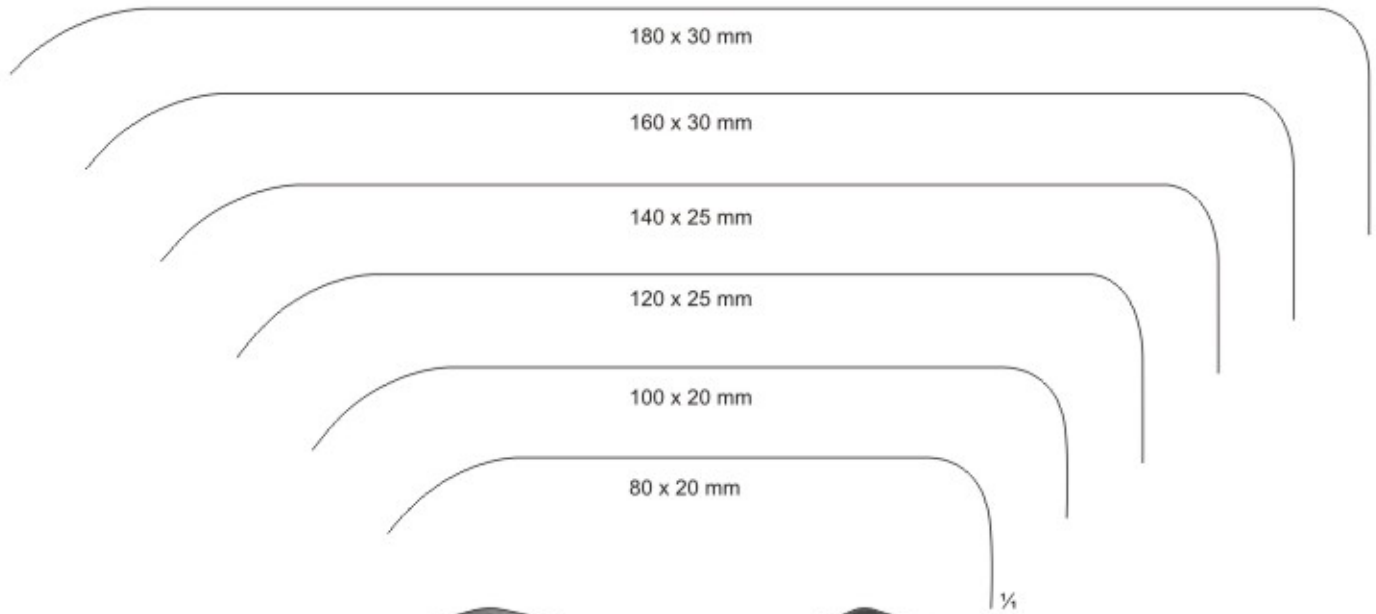

- 19-468-240 80 x 20 mm
- 19-469-240 100 x 20 mm
- 19-470-240 120 x 25 mm
- 19-471-240 140 x 25 mm
- 19-472-240 160 x 30 mm
- 19-473-240 180 x 30 mm

**BRUNNER**  
24 cm, 9 1/2"



- 19-474-240 80 x 20 mm
- 19-475-240 100 x 20 mm
- 19-476-240 120 x 25 mm
- 19-477-240 140 x 25 mm
- 19-478-240 160 x 30 mm
- 19-479-240 180 x 30 mm

**BRUNNER**  
24 cm, 9 1/2"



## RETRACTORS

Wundhaken  
Separadores

Ecarteurs  
Divaricatori



**SAUERBRUCH**  
22.5 cm, 9"



**19-480-225**  
22.5 cm, 9"  
50 x 15 mm



**19-481-225**  
22.5 cm, 9"  
63 x 23 mm



**19-482-225**  
22.5 cm, 9"  
80 x 20 mm



**DOYEN-STILLE**  
**A** 19-483-260 26 cm, 10 1/4"  
97 x 29 mm  
**B** 19-484-260 26 cm, 10 1/4"  
101 x 31 mm  
**C** 19-485-260 26 cm, 10 1/4"  
152 x 27 mm

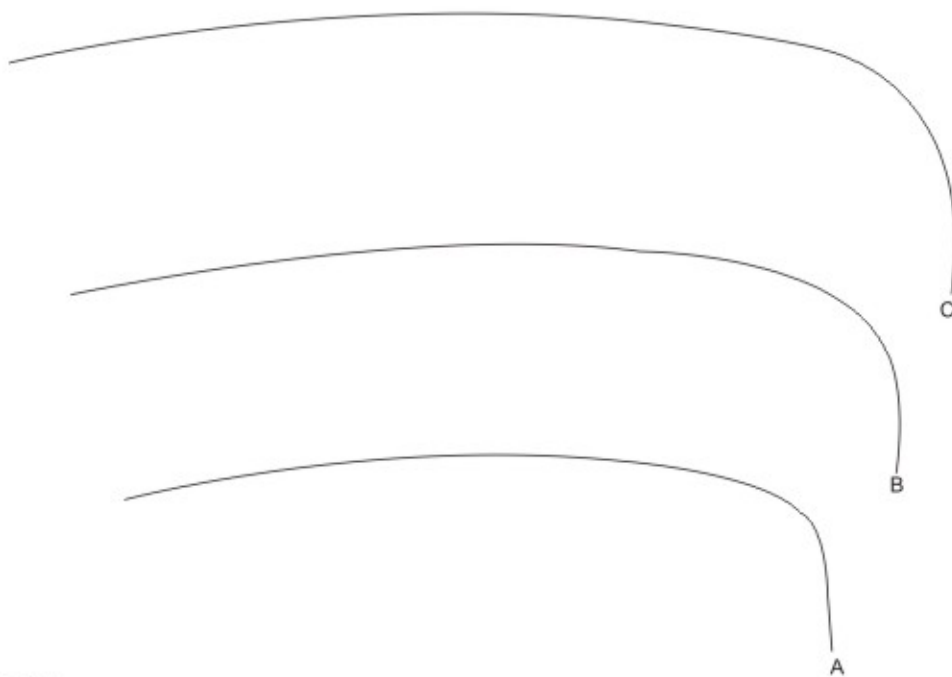

# RETRACTORS



Wundhaken  
Separadores

Ecarteurs  
Divaricatori



**HOSEL**  
25 cm, 10"



**19-486-250**  
60 x 20 mm



**19-487-250**  
80 x 30 mm



**19-488-250**  
100 x 30 mm



**19-489-250**  
120 x 30 mm



**19-490-250**  
140 x 30 mm



**19-491-250**  
140 x 40 mm





## RETRACTORS

Wundhaken  
Separadores

Ecarteurs  
Divaricatori







## RETRACTORS

Wundhaken  
Separadores

Ecarteurs  
Divaricatori

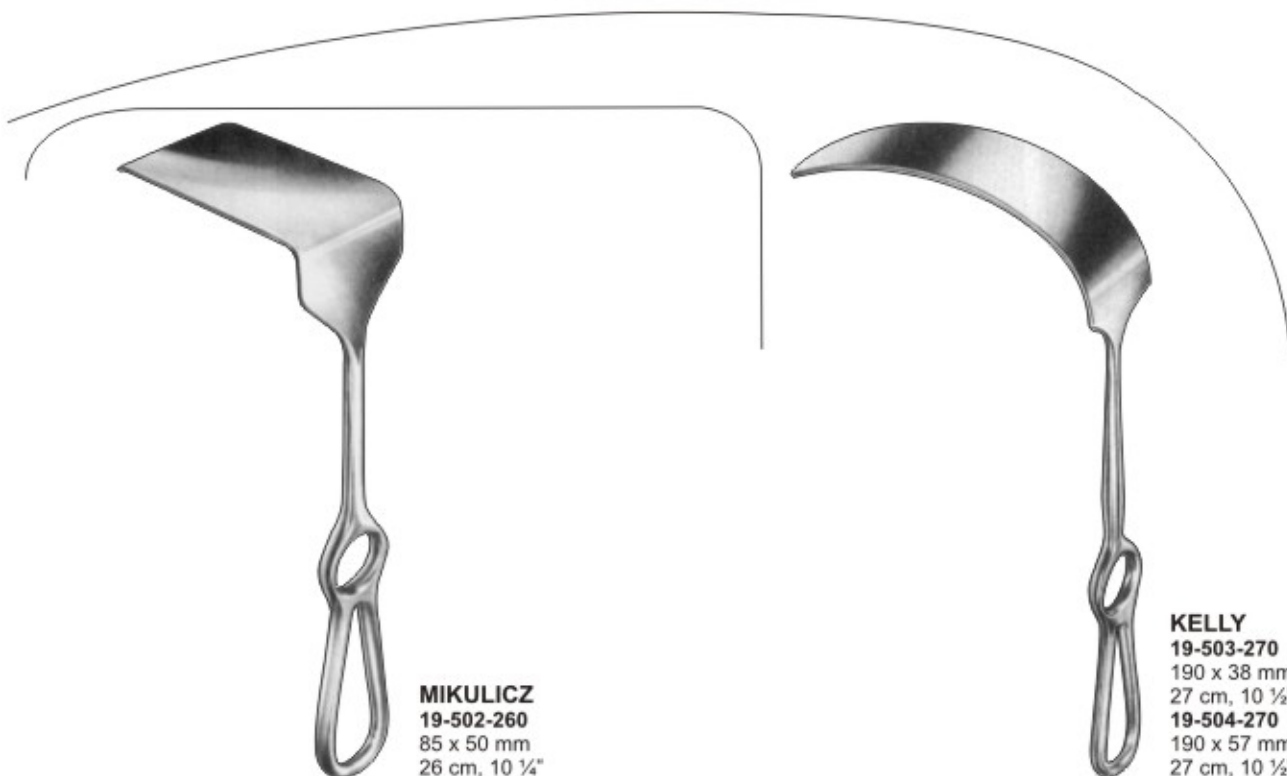

**MIKULICZ**  
19-502-260  
85 x 50 mm  
26 cm, 10 1/4"

**KELLY**  
19-503-270  
190 x 38 mm  
27 cm, 10 1/2"  
19-504-270  
190 x 57 mm  
27 cm, 10 1/2"

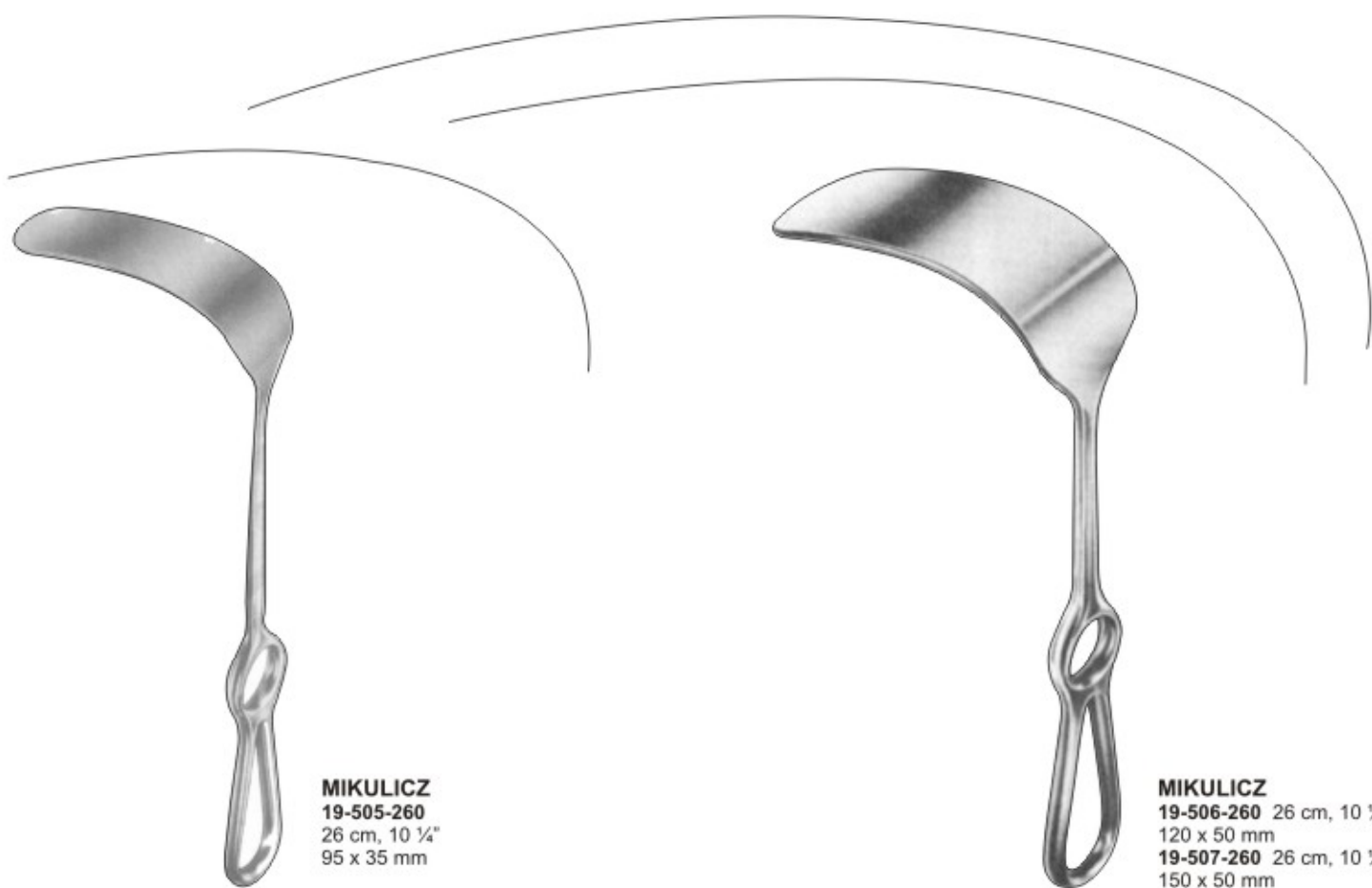

**MIKULICZ**  
19-505-260  
26 cm, 10 1/4"  
95 x 35 mm

**MIKULICZ**  
19-506-260 26 cm, 10 1/4"  
120 x 50 mm  
19-507-260 26 cm, 10 1/4"  
150 x 50 mm

# RETRACTORS



Wundhaken  
Separadores

Ecarteurs  
Divaricatori



**CHEEK-AND LIP  
RETRACTOR  
MOVABLE**  
19-508-190  
19 cm, 7 1/2"



**TUFFIER**  
19-509-230 55 x 63 mm  
23 cm, 9"

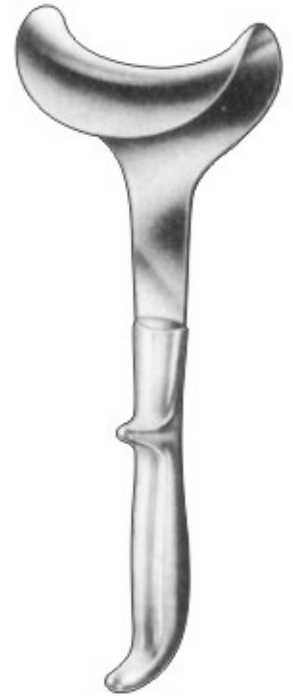

**DOYEN**  
19-510-250 50 x 85 mm  
25 cm, 10"



**FRITCH RETRACTOR**  
19-511-001  
2.75 x 2 mm



**FRITSCH**  
19-512-240 35 x 40 mm  
24 cm, 9 1/2"



**FRITSCH**  
19-513-240 24 cm, 9 1/2" 30 x 30 mm  
19-514-240 24 cm, 9 1/2" 32 x 40 mm  
19-515-240 24 cm, 9 1/2" 40 x 50 mm  
19-516-240 24 cm, 9 1/2" 40 x 60 mm  
19-517-240 24 cm, 9 1/2" 45 x 75 mm  
19-518-240 24 cm, 9 1/2" 65 x 85 mm



## RETRACTORS

Wundhaken  
Separadores

Ecarteurs  
Divaricatori

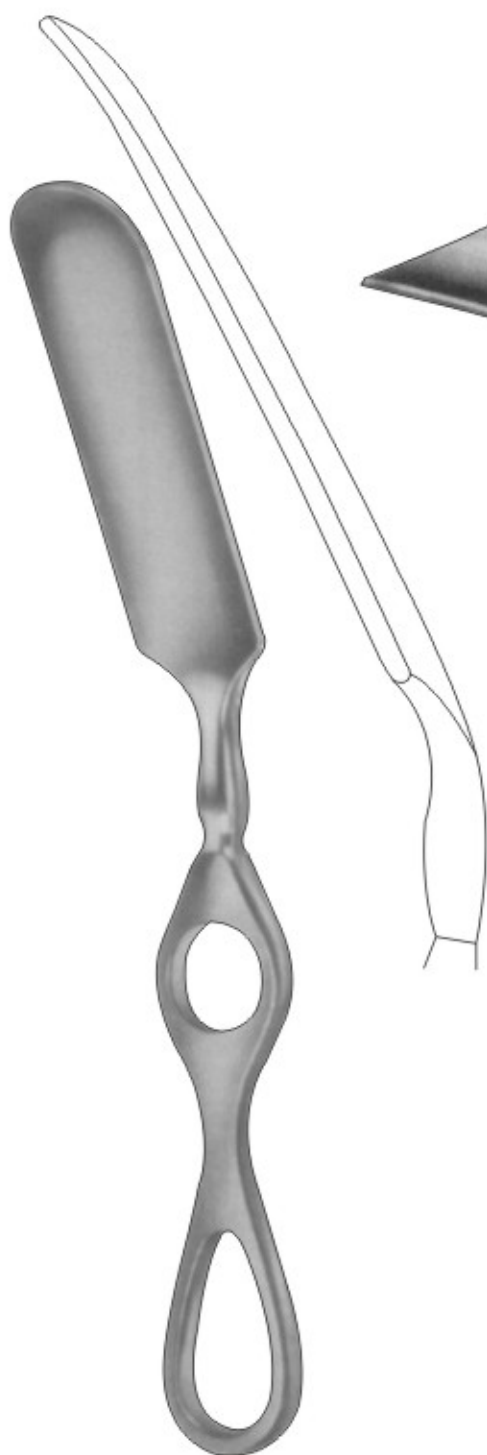

**MIKULICZ**  
19-519-290  
29 cm 11.5"

64 x 60mm

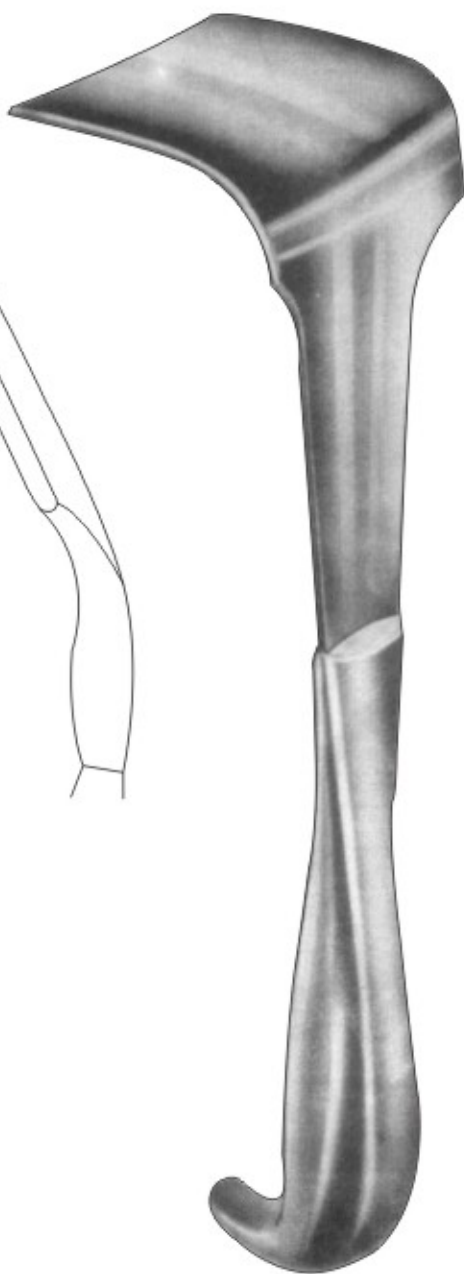

**TUFFIER**  
19-520-230  
23 cm 9"



**HARRINGTON**  
19-521-320  
32 cm, 12 3/4" 127 x 40 mm  
19-522-320  
32 cm, 12 3/4" 127 x 62 mm



Wundhaken  
Separadores

Ecarteurs  
Divaricatori



**DEAVER**  
19-523-310  
31.0 cm 12"



**DEAVER**  
19-524-310  
31.0 cm 12"



## RETRACTORS

Wundhaken  
Separadores

Ecarteurs  
Divaricatori



50 mm

**DEAVER**  
19-525-305  
30.5 cm 12"



75 mm

**DEAVER**  
19-526-310  
31.0 cm 12"

Wundhaken  
Separadores

# RETRACTORS

Ecarteurs  
Divaricatori

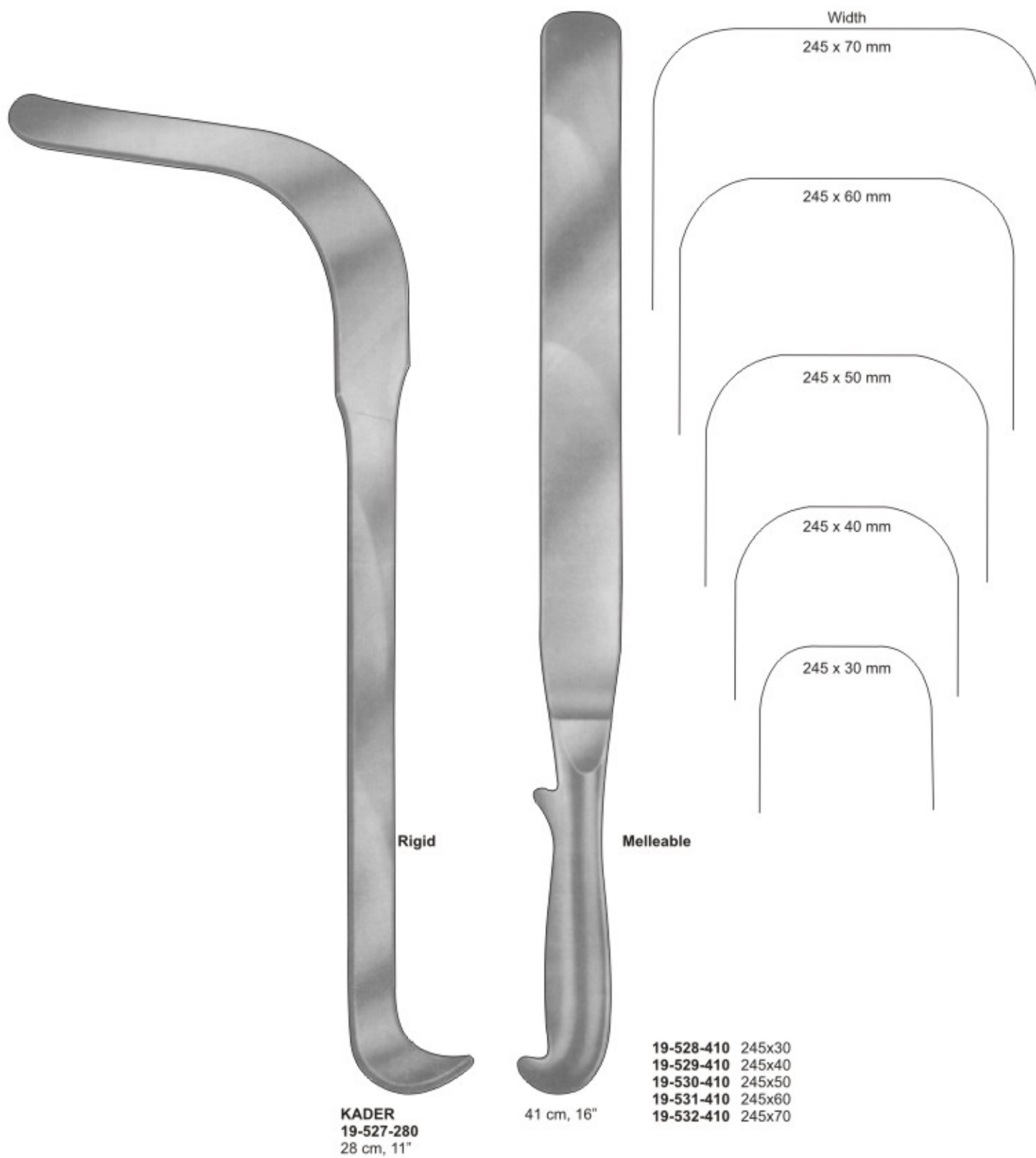

**KADER**  
19-527-280  
28 cm, 11"

41 cm, 16"

- 19-528-410 245x30
- 19-529-410 245x40
- 19-530-410 245x50
- 19-531-410 245x60
- 19-532-410 245x70





## RETRACTORS

Wundhaken  
Separadores

Ecarteurs  
Divaricatori



**LERICHE**  
19-533-310  
31 cm, 12 ½"

**LERICHE**  
19-534-330  
33 cm, 13"

**KUEMMEL**  
19-535-330  
malleable  
33 cm, 13"  
46 mm

**KUMMEL**  
19-536-330  
33 cm, 13"

# RETRACTORS



Wundhaken  
Separadores

Ecarteurs  
Divaricatori





# RETRACTORS, VEIN HOOKS

Wundhaken, Venenhäkchen  
Separadores, Ganchitos Para venas

Ecarteurs, Ecarteurs sous  
Divaricatori, Divaricatori per veni



**MEYERDING**  
19-541-225 75 x 25mm  
22.5 cm, 9"



19-542-225 50 x 16mm  
22.5 cm, 9"



19-543-225 75 x 15mm  
22.5 cm, 9"

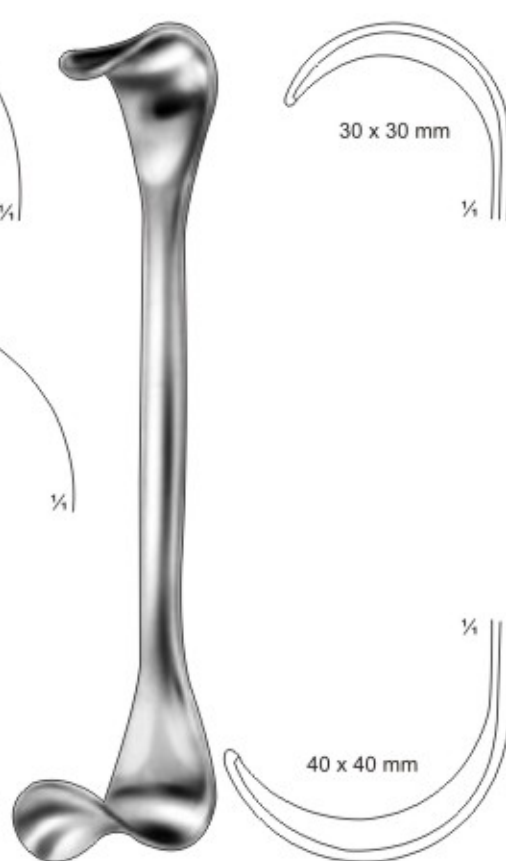

**GOELET**  
19-544-190  
19 cm 7 1/2"  
Double Ended

30 x 30 mm

40 x 40 mm



**KAYE-MILLARD**  
19-545-080  
8 cm, 3 1/4"



**RICHARDSON/KELLY**



19-546-240 25 x 31mm  
24 cm, 9 1/2"



19-547-240 19 x 51mm  
24 cm, 9 1/2"



19-548-240 38 x 51mm  
24 cm, 9 1/2"



19-549-240 64 x 76mm  
24 cm, 9 1/2"

# RETRACTORS



Wundhaken  
Separadores

Ecarteurs  
Divaricatori



**ROSS**  
25.5 cm, 10"



**19-550-255**  
Fig.01



**19-551-255**  
Fig.02



**19-552-255**  
Fig.03



**19-553-255**  
Fig.04



**19-554-255**  
Fig.05



**19-555-255**  
Fig.06



**WEINBERG VAGOTOMY  
RETRACTOR (JOE'S HOE)**  
**19-556-200**  
20 cm, 8"  
Blade 102 x 165 mm wide



**TURNER-DOYEN  
RETRACTORS**  
**19-557-235**  
Blade 140 x 60 mm wide  
**19-558-235**  
Blade 76 x 140 mm wide  
**19-559-235**  
Blade 165 x 76 mm wide  
23.5 cm 9 1/2"

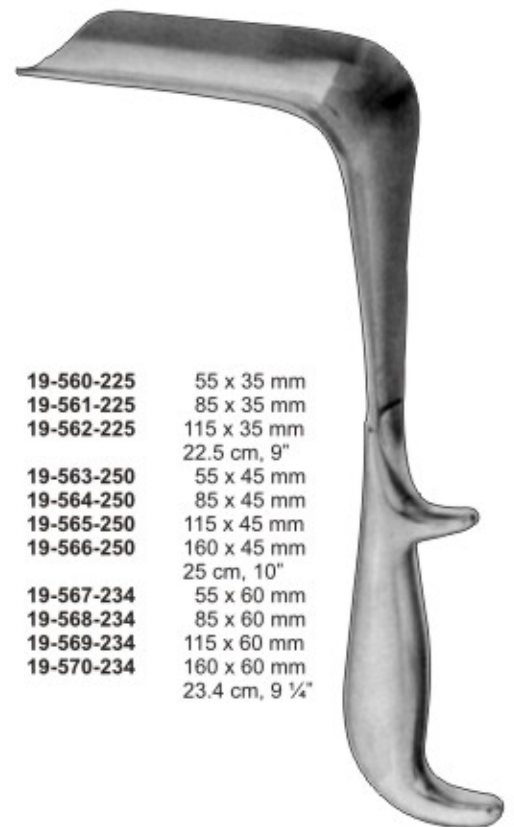

**19-560-225** 55 x 35 mm  
**19-561-225** 85 x 35 mm  
**19-562-225** 115 x 35 mm  
22.5 cm, 9"  
**19-563-250** 55 x 45 mm  
**19-564-250** 85 x 45 mm  
**19-565-250** 115 x 45 mm  
**19-566-250** 160 x 45 mm  
25 cm, 10"  
**19-567-234** 55 x 60 mm  
**19-568-234** 85 x 60 mm  
**19-569-234** 115 x 60 mm  
**19-570-234** 160 x 60 mm  
23.4 cm, 9 1/4"

**DOYEN VAGINAL  
RETRACTORS**



## RETRACTORS

Wundhaken  
Separadores

Ecarteurs  
Divaricatori



**LEGUEU**  
19-571-270  
35 x 90 mm  
27 cm 10 ½"  
Bladder Spatula

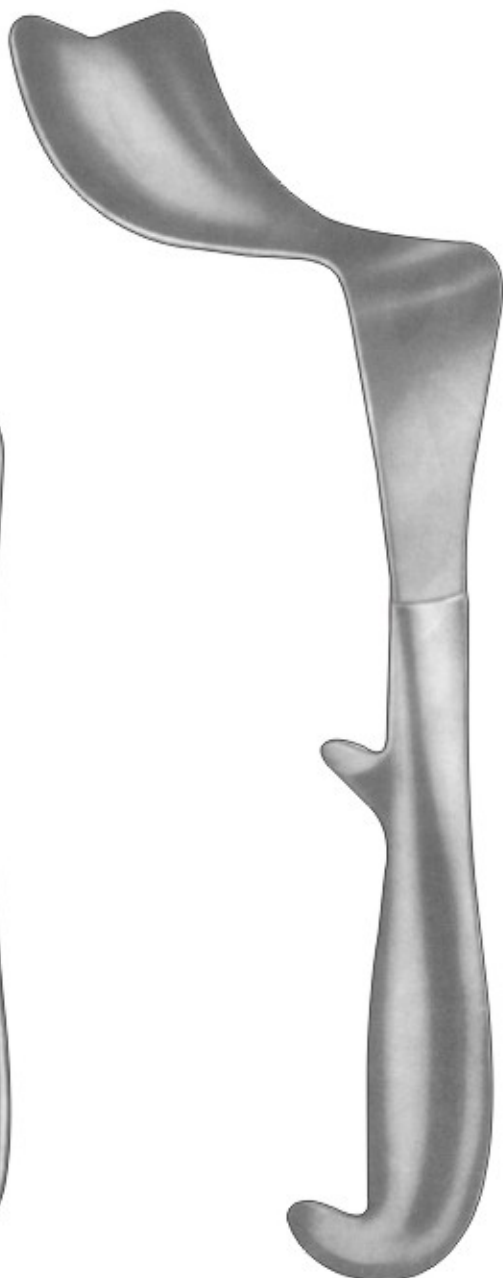

**KOCHER**  
19-572-260  
56 x 90 mm  
26 cm 10 ¼"



**KOCHER**  
19-573-260  
65 x 90 mm  
26 cm 10 ¼"

# RETRACTORS



Wundhaken  
Separadores

Ecarteurs  
Divaricatori

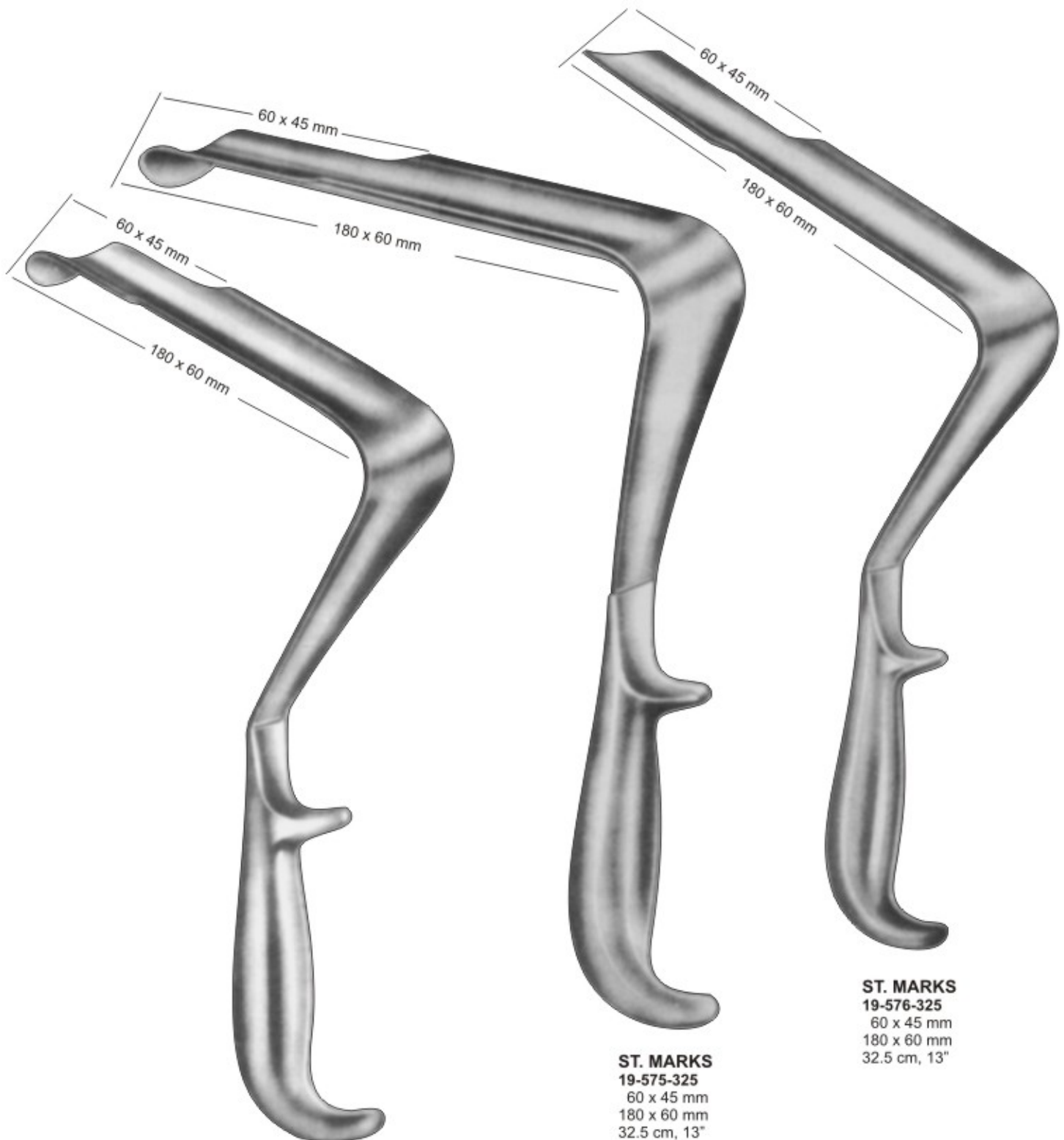

**ST. MARKS**  
**19-574-290**  
60 x 45 mm  
180 x 60 mm  
29 cm, 11 1/2"

**ST. MARKS**  
**19-575-325**  
60 x 45 mm  
180 x 60 mm  
32.5 cm, 13"

**ST. MARKS**  
**19-576-325**  
60 x 45 mm  
180 x 60 mm  
32.5 cm, 13"



## RETRACTORS

Wundhaken  
Separadores

Ecarteurs  
Divaricatori

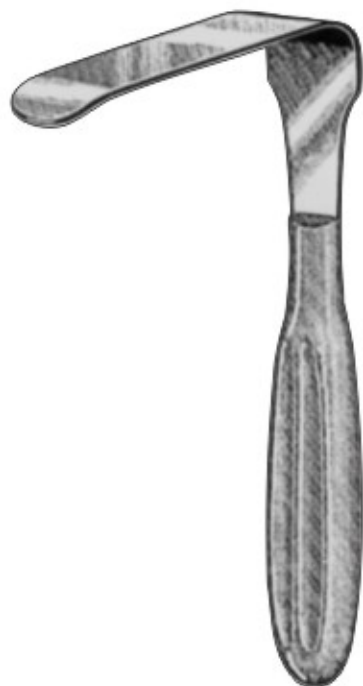

**BRANTLEY-TURNER  
RETRACTOR**  
19-577-180  
100 x 30 mm  
18 cm, 7"



**PRYOR-PEAN  
RETRACTOR**  
19-578-275  
115 x 25 mm  
27.5 cm, 10 3/4"



**ALLISON**  
19-579-300  
30 cm, 12" 40 mm  
19-580-320  
32 cm, 12 3/4" 54 mm  
lungenspatel Spatulas

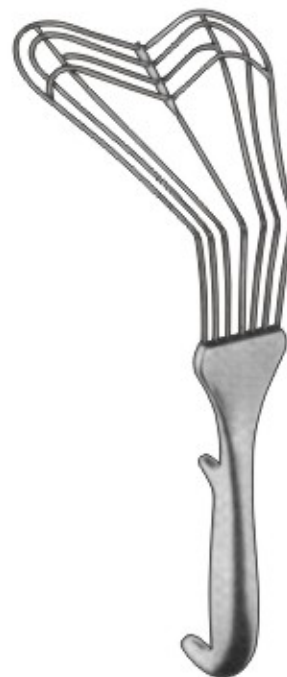

**ALLISON**  
19-581-300 132 mm  
30 cm, 12"



Wundhaken  
Separadores

Ecarteurs  
Divaricatori



**KOERTE**  
19-582-280  
120 x 45 mm  
28 cm, 11"



**KUEMME**  
19-583-280  
100 x 45 mm  
28 cm, 11"



**YOUNG**  
19-584-220  
22 cm, 8 3/4"

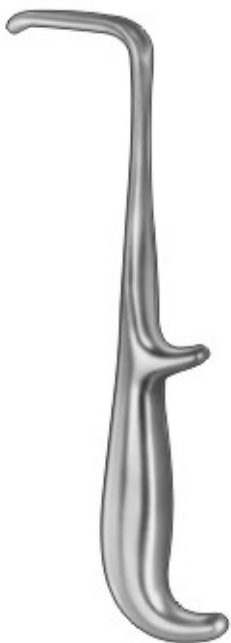

**YOUNG**  
19-585-215  
21.5 cm, 8 1/2"  
Prostatic Retractors



**YOUNG**  
19-586-215  
21.5 cm, 8 1/2"

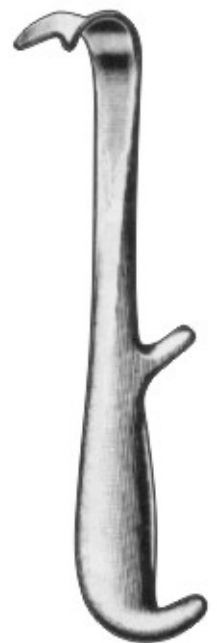

**YOUNG**  
19-587-220  
22 cm, 8 3/4"





## RETRACTORS

Wundhaken  
Separadores

Ecarteurs  
Divaricatori



**COOLEY**  
19-588-250  
25 cm, 10"  
Right



**COOLEY**  
19-589-270  
27 cm, 10 1/2"  
Left



**COOLEY**  
19-590-250  
25 cm, 10"  
Right - Serrated

# RETRACTORS



Wundhaken  
Separadores

Ecarteurs  
Divaricatori



**SAWYER  
RETRACTORS**

**19-591-230**  
Small Blade 70 mm x 19 mm wide  
23 cm 9"  
**19-592-250**  
Medium Blade 82 mm x 29 mm wide  
25 cm 10"



**FERGUSON-MOON  
RECTAL RETRACTORS**

**19-593-230**  
Blade 60 mm x 24 mm wide  
23 cm 9"  
**19-594-250**  
Blade 75 mm x 35 mm wide  
25 cm 10"



**HILL FERGUSON  
RECTAL RETRACTORS**

**19-595-230**  
Blade 64 mm x 24 mm wide  
23 cm 9"  
**19-596-230**  
Blade 76 mm x 32 mm wide  
23 cm 9"  
**19-597-250**  
Blade 76 mm x 35 mm wide  
25 cm 10"



**19-598-240** 24 cm 9 1/2"  
50 x 40 mm wide  
**19-599-240** 24 cm 9 1/2"  
65 x 50 mm wide  
**19-600-250** 25 cm 10"  
75 x 65 mm wide  
**19-601-250** 25 cm 10"  
90 x 75 mm wide

**KELLY  
RETRACTORS**

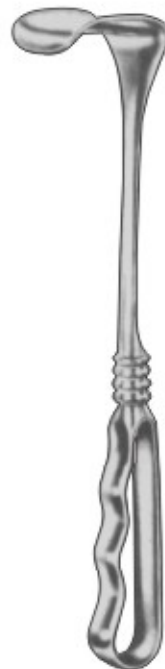

**RICHARDSON  
RETRACTORS**



**19-602-240** 24 cm 9 1/2"  
Blade 25 x 20 mm wide



**19-603-240** 24 cm 9 1/2"  
Blade 36 x 28 mm wide  
**19-604-240** 24 cm 9 1/2"  
Blade 44 x 28 mm wide



**19-605-250** 25 cm 10"  
Blade 52 x 22 mm wide  
**19-606-250** 25 cm 10"  
Blade 70 x 52 mm wide

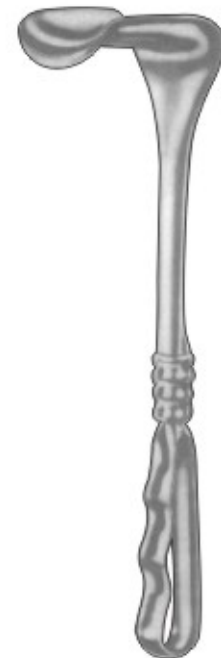

**KELLY  
19-607-250**  
55 x 50 mm  
25 cm, 10"



# RETRACTORS

Wundhaken  
Separadores

Ecarteurs  
Divaricatori

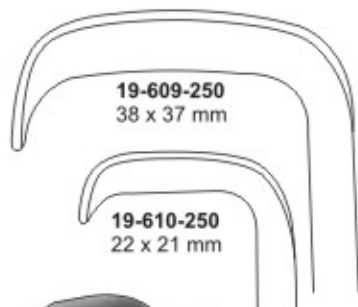

19-609-250  
38 x 37 mm

19-610-250  
22 x 21 mm



19-611-240  
23 x 20 mm



19-612-240  
30 x 29 mm



19-613-240  
37 x 37 mm



47 x 21 mm



19-610-250  
39 x 30 mm

19-609-250  
64 x 43 mm

**RICHARDSON-EASTMAN**  
19-608-250  
25.0 cm 10", Set of 2 piece



**RICHARDSON**  
24.0 cm 9.5"



**RICHARDSON**  
19-614-240  
24.0 cm 9.5"



Wundhaken  
Separadores

Ecarteurs  
Divaricatori

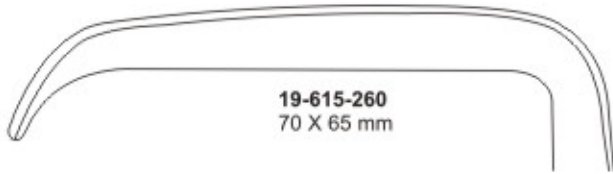

**19-615-260**  
70 X 65 mm



**19-616-260**  
64 X 54 mm

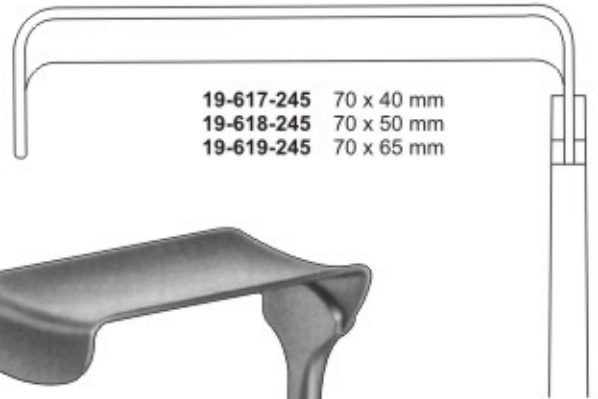

**19-617-245** 70 x 40 mm  
**19-618-245** 70 x 50 mm  
**19-619-245** 70 x 65 mm



**KELLY**  
26.0 cm 10 ¼"



**MORRIS**  
24.5 cm 9 ¾"



# RETRACTORS

Wundhaken  
Separadores

Ecarteurs  
Divaricatori



**MAYO ABDOMINAL  
RETRACTOR**  
19-620-001  
25 cm, 10"  
69 x 254 mm



**C.W. MAYO ABDOMINAL  
RETRACTOR**  
19-621-257 25.7 cm, 10 1/4"  
Blade 70 mm wide.  
19-622-248 24.8 cm, 10"  
Blade 79 mm wide.



**BREWSTER RETRACTOR**  
19-623-240 Style A 19 x 38 mm  
19-624-240 Style B 45 x 25 mm  
19-625-240 Style C 50 x 45 mm  
19-626-240 Style D 57 x 45 mm  
19-627-240 Style E 64 x 45 mm  
24 cm, 9 1/2"



**KELLY RETRACTOR**  
19-628-230 23 cm, 9" 38 x 50 mm  
19-629-240 24 cm, 9 1/2" 50 x 64 mm  
19-630-250 25 cm, 10" 64 x 76 mm  
19-631-260 26 cm, 10 1/4" 69 x 82 mm



**SIMS-KELLY RETRACTOR**  
19-632-240 57 x 25 mm  
19-633-240 69 x 45 mm  
19-634-240 76 x 38 mm  
24 cm, 9 1/2"



**ZAIKIND LUNG RETRACTOR**  
19-635-250 Malleable 50 x 305 mm  
19-636-250 Malleable 76 x 305 mm  
25 cm, 10"

# RETRACTORS



Wundhaken  
Separadores

Ecarteurs  
Divaricatori



## DE LEE CORNER RETRACTORS

**19-637-235** 23.5 cm, 9 1/4"  
Right Blade 70 x 51 mm wide  
**19-638-235** 23.5 cm, 9 1/4"  
Left Blade 70 x 51 mm wide

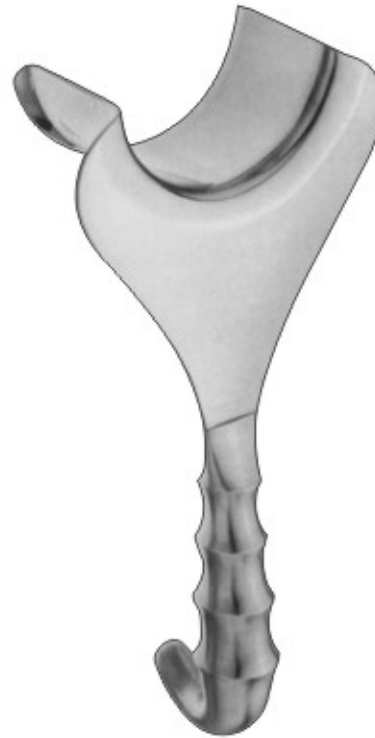

## DE LEE UNIVERSAL RETRACTORS

**19-639-235** 23.5 cm, 9 1/4"  
Blade 70 mm x 51 mm wide



## TAUBER VAGINAL SPATULA

**19-640-235** 23.5 cm, 9 1/4"  
Blade 89 x 35 mm wide



## HEANY

**19-641-270** 27 cm, 10 1/2", 45 x 25 mm  
**19-642-270** 27 cm, 10 1/2", 57 x 33 mm  
**19-643-270** 27 cm, 10 1/2", 80 x 33 mm



# RETRACTORS

Wundhaken  
Separadores

Ecarteurs  
Divaricatori



**19-644-250**  
25 cm, 10"  
35 x 8 mm

**19-645-265**  
26.5 cm, 10 1/2"  
60 x 12 mm

**19-646-275**  
27.5 cm, 10 3/4"  
75 x 12 mm

**19-647-285**  
28.5 cm, 11 1/4"  
85 x 20 mm

**19-648-305**  
30.5 cm, 12"  
100 x 25 mm

**ZENKER**



**19-649-190**  
15 X 15 mm

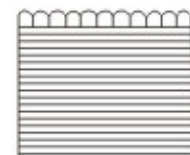

**19-650-190**  
15 X 23 mm

**CRAWFORD**  
19 cm, 7 1/2"



**19-651-275**  
20 mm



**19-652-275**  
30 mm



**19-653-275**  
40 mm

**KADER**  
27.5 cm, 10 3/4"

# RETRACTORS



Wundhaken  
Separadores

Ecarteurs  
Divaricatori



Item	Description	Tip
19-654-200	20 cm, 8"	12 mm
19-655-200	20 cm, 8"	17 mm
19-656-200	20 cm, 8"	25 mm
19-657-330	33 cm, 13"	25 mm
19-658-330	33 cm, 13"	32 mm
19-659-330	33 cm, 13"	40 mm
19-660-330	33 cm, 13"	50 mm

**MALLEABLE**



**RIBBON  
RETRACTOR**  
19-661-200  
20 cm, 8"  
Width 4 cm



**RIBBON  
RETRACTOR**  
19-662-200  
20 cm, 8"  
Width 2.5 cm



**TUFFIER / HABERER**  
malleable  
19-663-200 17 x 25 mm 20 cm, 8"  
19-664-280 25 x 30 mm 28 cm, 11"  
19-665-300 37 x 45 mm 30 cm, 11 3/4"



**REVERDIN**  
19-666-280  
28 cm, 11"  
46 x 60 mm



**REVERDIN**  
19-667 -290  
29 cm, 11 1/2"



**BLOOD SCOOP**  
19-668-150  
15 cm, 6"





# RETRACTORS

Wundhaken  
Separadores

Ecarteurs  
Divaricatori



**HEISS**  
19-669-100 10 cm, 4"  
Sharp 4:4  
19-670-100 10 cm, 4"  
Blunt 4:4

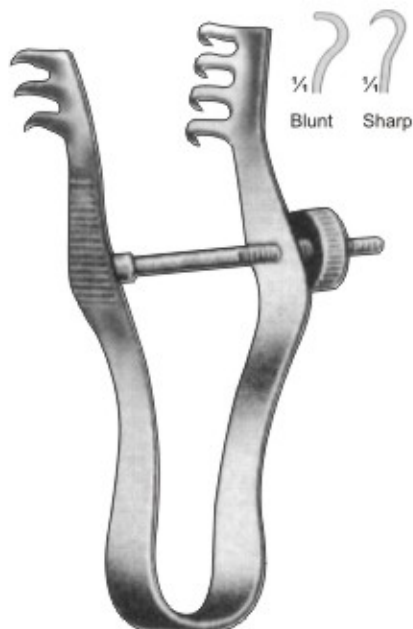

**FINSEN**  
19-671-070 7 cm, 2 3/4"  
3 x 4 teeth, sharp  
19-672-070 7 cm, 2 3/4"  
3 x 4 teeth, Blunt



**FINSEN**  
19-673-050 5 cm, 2"  
2 x 3 teeth sharp/blunt  
19-674-070 7 cm, 2 3/4"  
2 x 3 teeth sharp/blunt



**BUCKLEY**  
19-675-060  
6 cm, 2 1/2"

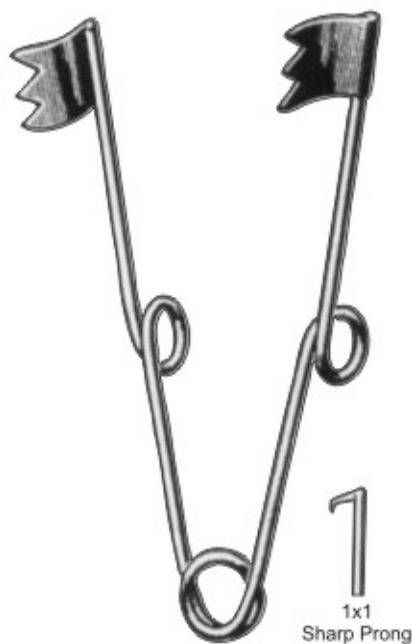

**WIRE RETAINING  
RETRACTOR**  
19-676-085 8.5 cm, 3 1/2" 3 x 3 Prong  
19-677-085 8.5 cm, 3 1/2" 1 x 1 Prong Sharp

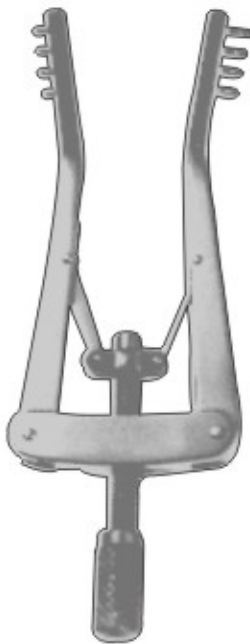

**ALM**  
19-678-070 7 cm, 2 3/4"  
4 x 4 teeth sharp/blunt  
19-679-070 10 cm, 4"  
4 x 4 teeth sharp/blunt



**JANSEN**  
19-680-100 10 cm, 4"  
Sharp 3:3  
19-681-100 10 cm, 4"  
Blunt 3:3

# RETRACTORS



Wundhaken  
Separadores

Ecarteurs  
Divaricatori



**WALTON**  
19-682-180 Sharp  
19-683-180 Blunt  
18 cm, 7"



**KNIGHTON**  
19-684-180 Sharp  
19-685-180 Blunt  
18 cm, 7"



**RICHTER**  
19-686-165  
16.5 cm, 6 1/2"



**SCALP-CONTOUR**  
19-687-140 Sharp  
19-688-140 Blunt  
14 cm, 5 1/2"



## RETRACTORS

Wundhaken  
Separadores

Ecarteurs  
Divaricatori



**HENLEY**

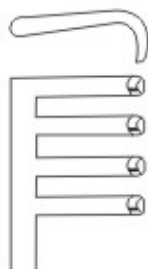

**19-689-160**  
16 cm, 6 1/4"  
3 : 4 mm  
blunt

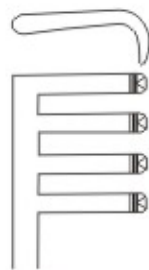

**19-690-160**  
16 cm, 6 1/4"  
3 : 4 mm  
sharp



**HOUZEL**  
19-691-290  
29 cm, 11 1/2"



**HORIZONTAL  
RETRACTOR**  
19-692-330  
33 cm, 13"



**MOLLISON**  
19-693-150  
15 cm, 6"  
sharp

# RETRACTORS



Wundhaken  
Separadores

Ecarteurs  
Divaricatori



### DARLING

**19-694-180** 18 cm, 7"  
40 x 76/25 x 54 mm  
**19-695-180** 18 cm, 7"  
25 x 64/40 x 76 mm  
Laminectomy Retractors  
1 blade toothed

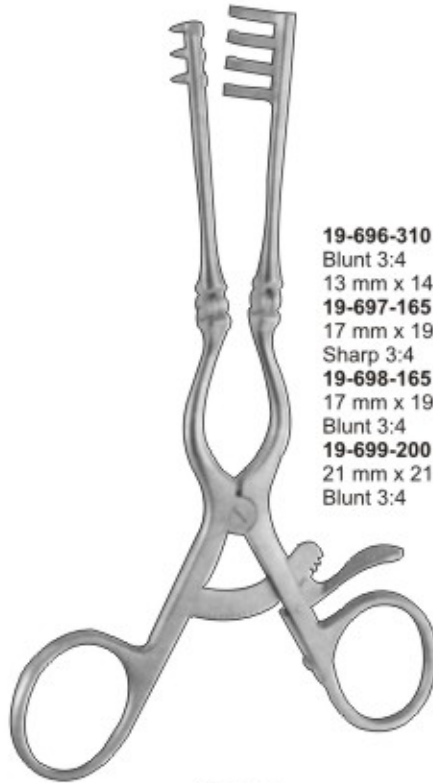

### CONE

**19-696-310** 31 cm, 12"  
Blunt 3:4  
13 mm x 14.5 mm  
**19-697-165** 16.5 cm, 6 1/2"  
17 mm x 19 mm  
Sharp 3:4  
**19-698-165** 16.5 cm, 6 1/2"  
17 mm x 19 mm  
Blunt 3:4  
**19-699-200** 20 cm, 8"  
21 mm x 210 mm  
Blunt 3:4



### GELPI-LOKTITE

**19-700-090** 9 cm, 3 1/2"  
6 mm Sharp  
**19-701-110** 11 cm, 4 1/4"  
10 mm Sharp  
**19-702-140** 14 cm, 5 1/2"  
10 mm Sharp  
**19-703-190** 19 cm, 7 1/2"  
10 mm Sharp



### GELPI-LOKTITE

**19-704-180**  
18 cm, 7"



### MARKHAM/MEYERDING

**19-705-180**  
18 cm, 7" Blade 55 x 25 mm Left  
**19-706-180**  
18 cm, 7" Blade 55 x 25 mm Right



### MILLIGAN

**19-707-130**  
18.5 mm x 20 mm  
Blunt, 3:3  
13 cm, 5"



# RETRACTORS

Wundhaken  
Separadores

Ecarteurs  
Divaricatori



**MISKIMON**  
19-708-220 22 cm, 8 3/4"  
33 mm x 38 mm  
Sharp, 7:7



**MAYO-ADAMS**  
19-709-170 17 cm, 6 3/4"  
2 x 2 teeth blunt



**TUEBINGER MODELL**  
19-710-160  
16 cm, 6 1/4"

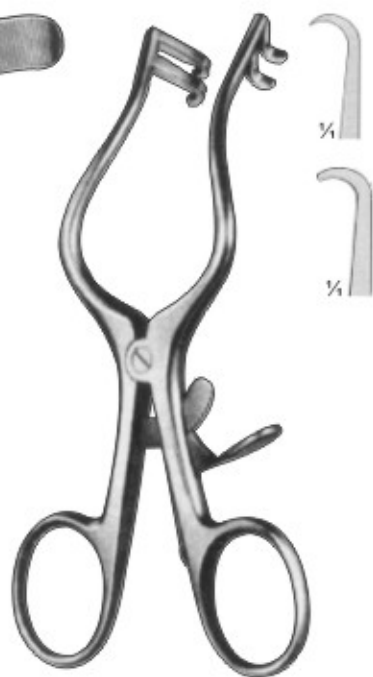

**PLESTER**  
19-711-130  
13 cm, 5"  
2 x 2 teeth  
sharp/blunt



**PLESTER**



**19-712-110**  
11 cm, 4 1/2"  
fig. 1 Blunt



**19-713-110**  
11 cm, 4 1/2"  
fig. 2 Blunt



**ADSON**



**19-714-320**  
32 cm, 12 3/4"  
semi-sharp  
4 x 5 teeth  
26 mm



**ADSON-BABY**  
19-715-160  
16 cm, 6 1/4" sharp  
3 x 4 teeth  
13 mm



**ADSON-BABY**  
19-716-160  
16 cm, 6 1/4" blunt  
3 x 4 teeth  
13 mm

# RETRACTORS



Wundhaken  
Separadores

Ecarteurs  
Divaricatori



**SCHUHKNECHT**  
19-717-140 Sharp  
19-718-140 Blunt  
14 cm, 5 1/2"



**WULLSTEIN**  
19-719-220 Sharp  
19-720-220 Sharp  
19-721-220 Sharp  
19-722-220 10.5 cm, 4"  
19-723-220 13.0 cm, 5"  
19-724-220 16.0 cm, 6 1/4"  
Blunt



**TRAVERS**  
19-725-210  
21 cm, 8 1/4"



**RIGHTBY**  
19-726-180 35 x 20 mm  
19-727-180 60 x 20 mm  
19-728-180 65 x 15 mm  
18 cm, 7"



**MISKIMON**  
19-729-220 Sharp  
19-730-220 Blunt  
22 cm, 8 3/4"



## RETRACTORS

Wundhaken  
Separadores

Ecarteurs  
Divaricatori



**WEITLANER**  
Sharp  
19-731-130  
13.0 cm 5.25"



**WEITLANER**  
Sharp  
19-732-165  
16.5 cm 6.5"

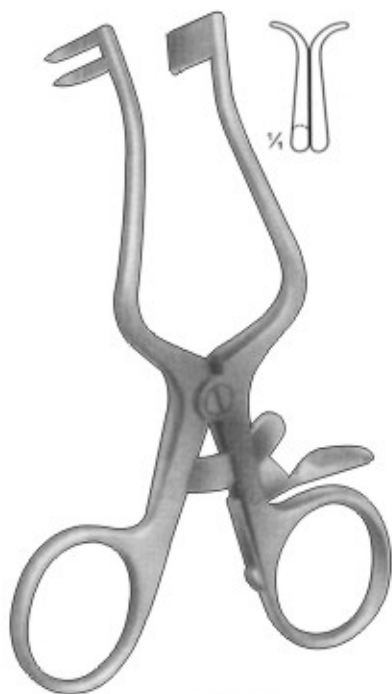

**PLESTER**  
Blunt  
19-733-110  
11.0 cm 4.25"

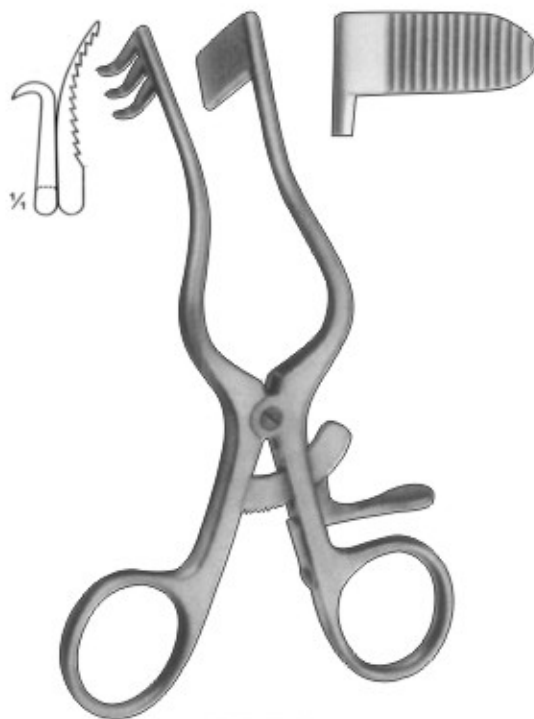

**PERKINS**  
19-734-130  
13.0 cm 5.25"

# RETRACTORS



Wundhaken  
Separadores

Ecarteurs  
Divaricatori

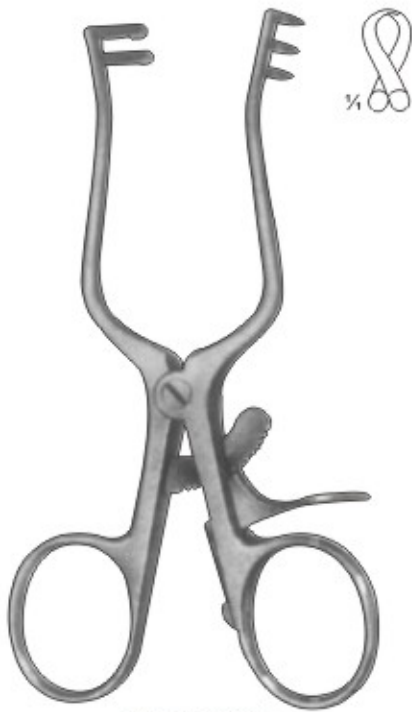

**WEITLANER**  
19-735-110  
Sharp  
11.0 cm



**WEITLANER**  
19-736-110  
Semi-Sharp  
11.0 cm



**WEITLANER**  
19-737-110  
Blunt  
11.0 cm



**WEITLANER**  
19-738-130  
Sharp  
13.0 cm



**WEITLANER**  
19-739-130  
Semi-Sharp  
13.0 cm

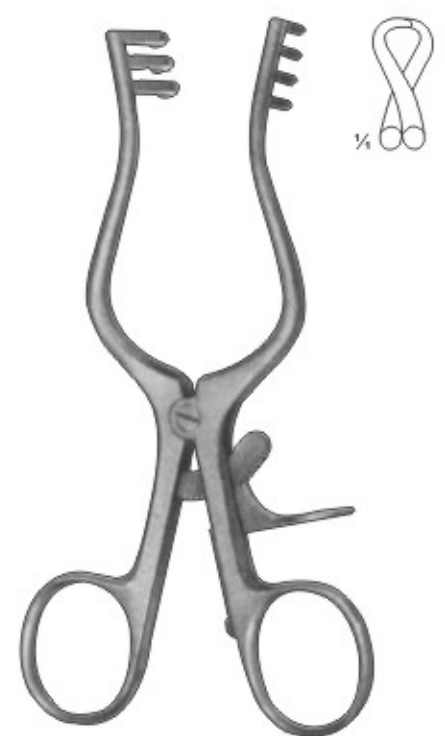

**WEITLANER**  
19-740-130  
Blunt  
13.0 cm





## RETRACTORS

Wundhaken  
Separadores

Ecarteurs  
Divaricatori



**WILLIGER**  
19-741-120  
12.0 cm, 5"



**MAYO-ADAMS**  
19-742-165  
16.5 cm 6 1/2"



**ADSON-BABY**  
19-743-140  
14.0 cm 5 1/2"  
Blunt

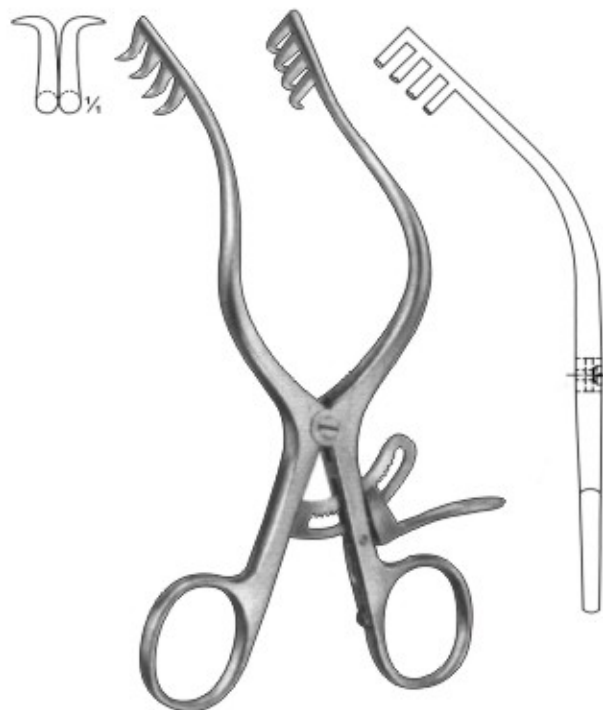

**MOLLISON**  
19-744-155  
15.5 cm 6"  
Sharp

# RETRACTORS



Wundhaken  
Separadores

Ecarteurs  
Divaricatori

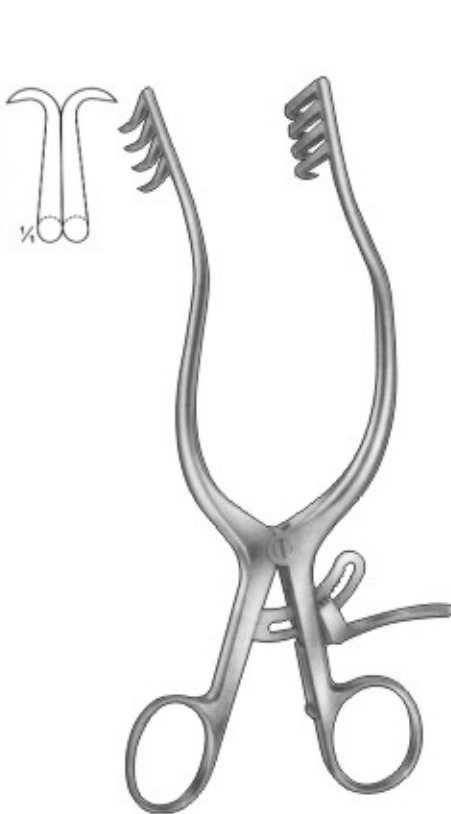

**ANDERSON-ADSON**  
19-745-190  
19.0 cm 7 1/2"  
Sharp

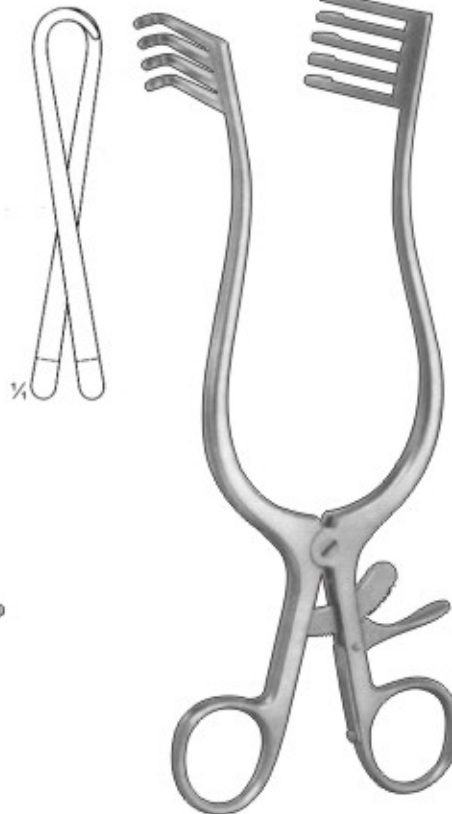

**NORFOLK &  
NORWICH**  
19-746-220  
22.0 cm 8 3/4"  
Blunt

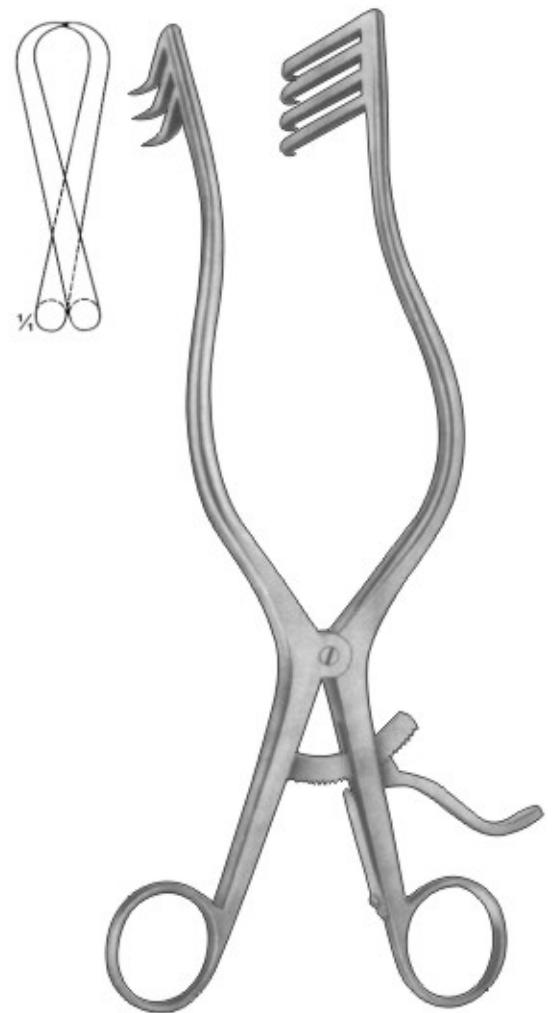

**ADSON**  
19-747-265  
26.5 cm 10 1/4"  
Sharp



## RETRACTORS

Wundhaken  
Separadores

Ecarteurs  
Divaricatori



1/4  
Sharp



1/4  
Semi-Sharp



1/4  
Semi-Sharp

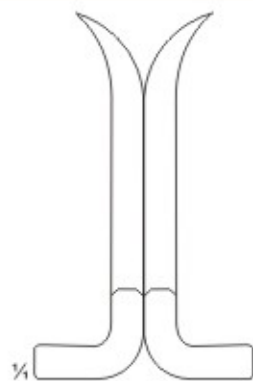

1/4

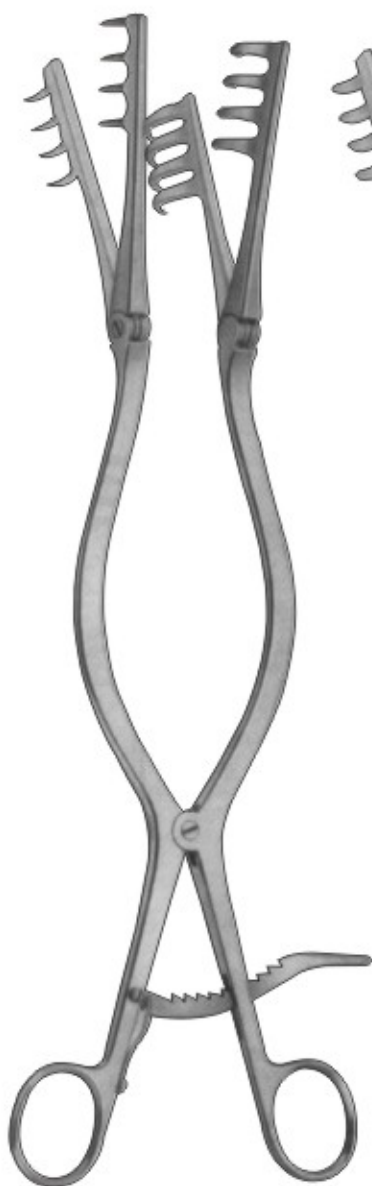

**BECKMANN-ADSON**  
19-748-310  
31 cm, 12 1/4"  
Sharp



**BECKMANN-ADSON**  
19-749-310  
31 cm, 12 1/4"  
Semi-Sharp



**ADSON**  
19-750-320  
32 cm, 12 1/2"  
Semi-Sharp



**BECKMANN-EATON**  
19-751-320  
32 cm, 12 1/2"  
Sharp

# RETRACTORS



Wundhaken  
Separadores

Ecarteurs  
Divaricatori

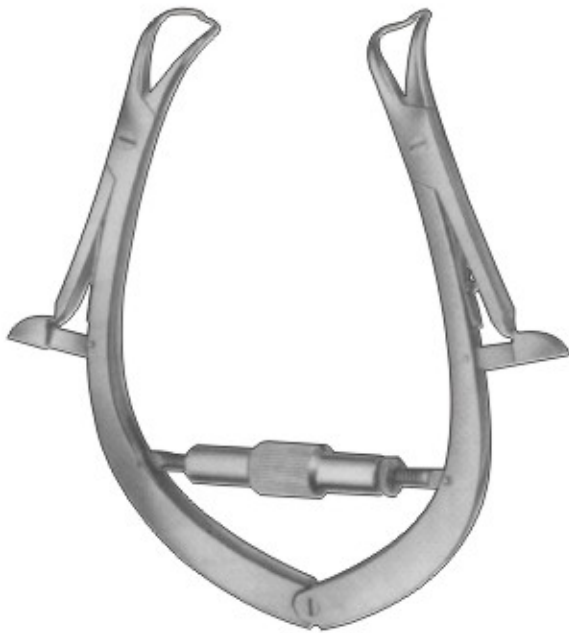

**JOLL (Friedman)**  
**19-752-155**  
Thyroid- and Vaginal Retractor  
15.5 cm, 6 1/2"

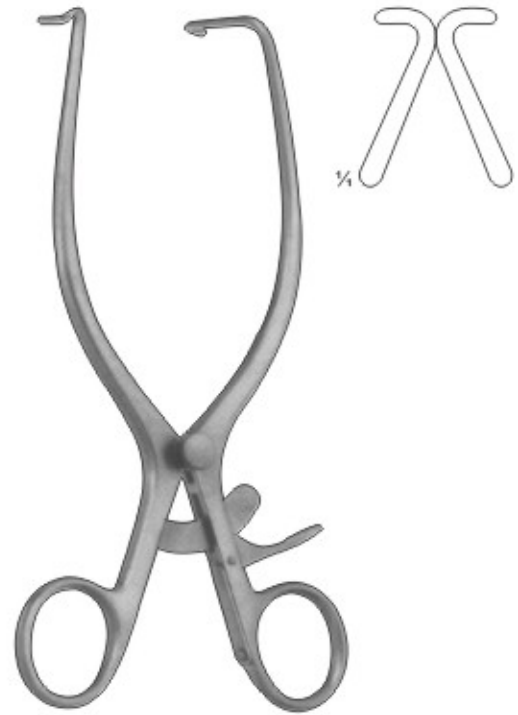

**JACKSON BURROWS**  
**Retractor**  
**19-753-185**  
blunt  
18.5 cm, 7"



**GELPI**  
Vaginal Retractor  
**19-754-135**  
13.5 cm, 5"

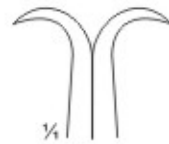

**GELPI**  
Skin- and Vaginal Retractor  
**19-755-175**  
17.5 cm, 7"



**DE BAKEY**  
Femur Retractor  
**19-756-145**  
14.5 cm, 4 1/2"



# RETRACTORS

Wundhaken  
Separadores

Ecarteurs  
Divaricatori



CLOWARD modif.  
**19-757-000**  
Spreader Only



16 mm  
**19-758-000**



16 mm  
**19-759-000**



16 mm  
**19-760-000**



16 mm  
**19-761-000**

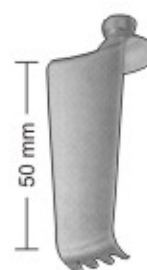

16 mm  
**19-762-000**

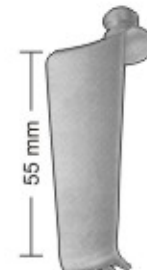

16 mm  
**19-763-000**

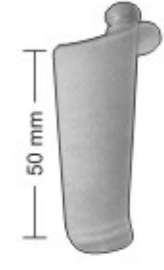

16 mm  
**19-764-000**

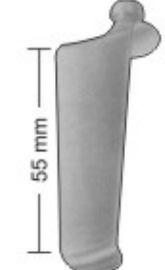

16 mm  
**19-765-000**

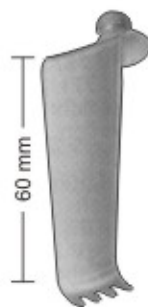

16 mm  
**19-766-000**



16 mm  
**19-767-000**



Wundhaken  
Separadores

Ecarteurs  
Divaricatori

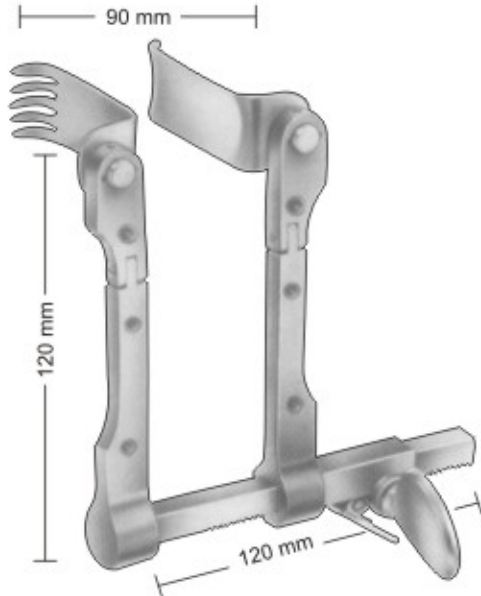

**CASPAR  
19-768-000**

Retractor, adjustable,  
consisting of: 5 medial  
blades, 5 Lateral blades.

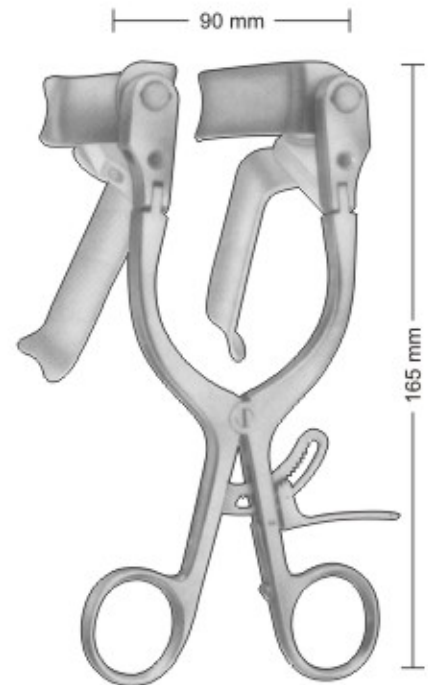

**CASPAR  
19-769-000**

Counter retractor, adjustable,  
consisting of: 5 medial blades,  
5 lateral blades.



**19-770-000** 40 x 23 mm  
**19-771-000** 45 x 23 mm  
**19-772-000** 50 x 23 mm  
**19-773-000** 55 x 23 mm  
**19-774-000** 60 x 23 mm  
Medial blades



**19-775-000** 40 x 23 mm  
**19-776-000** 45 x 23 mm  
**19-777-000** 50 x 23 mm  
**19-778-000** 55 x 23 mm  
**19-779-000** 60 x 23 mm  
Lateral blades



**19-780-000** 45 x 23 mm  
**19-781-000** 50 x 23 mm  
**19-782-000** 55 x 23 mm  
**19-783-000** 60 x 23 mm  
**19-784-000** 60 x 23 mm  
Blunt blades



**19-785-000** 50 x 25 mm  
**19-786-000** 55 x 25 mm  
Blunt blades,  
for harvesting of the  
fusion graft from the  
iliac crest



## RETRACTORS

Wundhaken  
Separadores

Ecarteurs  
Divaricatori

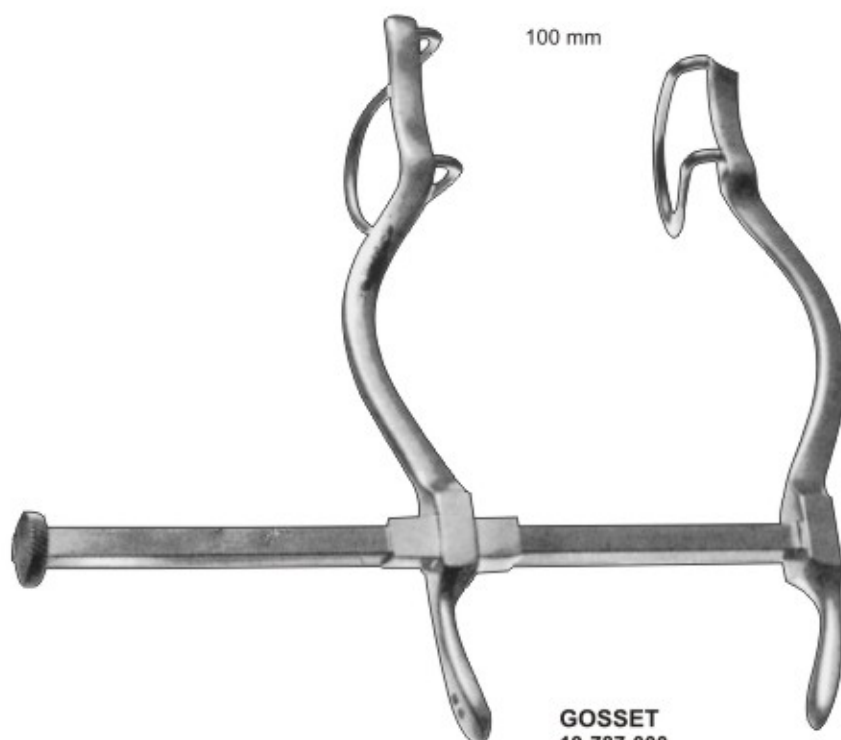

**GOSSET**  
**19-787-000**  
Center Blades 40 x 30 mm

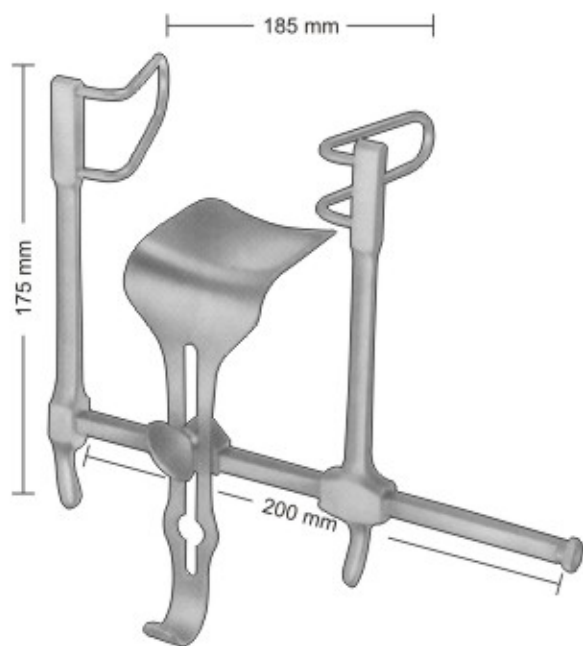

**GOSSET**  
**19-788-000**  
Lateral Blades 58 mm deep  
Center blade 59 x 57 mm

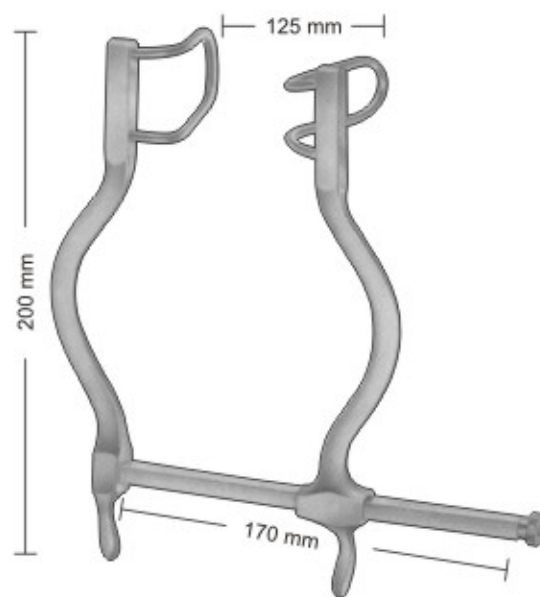

**GOSSET**  
**19-789-000**  
Blades: 55mm deep

# RETRACTORS



Wundhaken  
Separadores

Ecarteurs  
Divaricatori

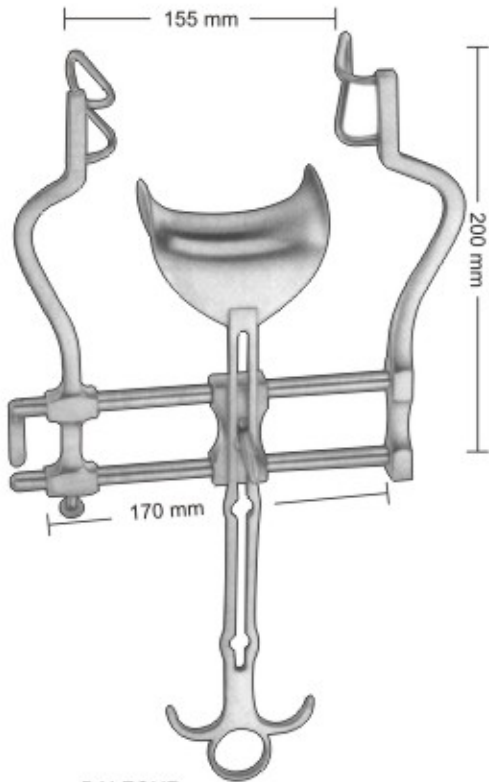

**BALFOUR**  
**19-790-000**  
Lateral blades 60 mm deep  
Center blade 47 x 80 mm

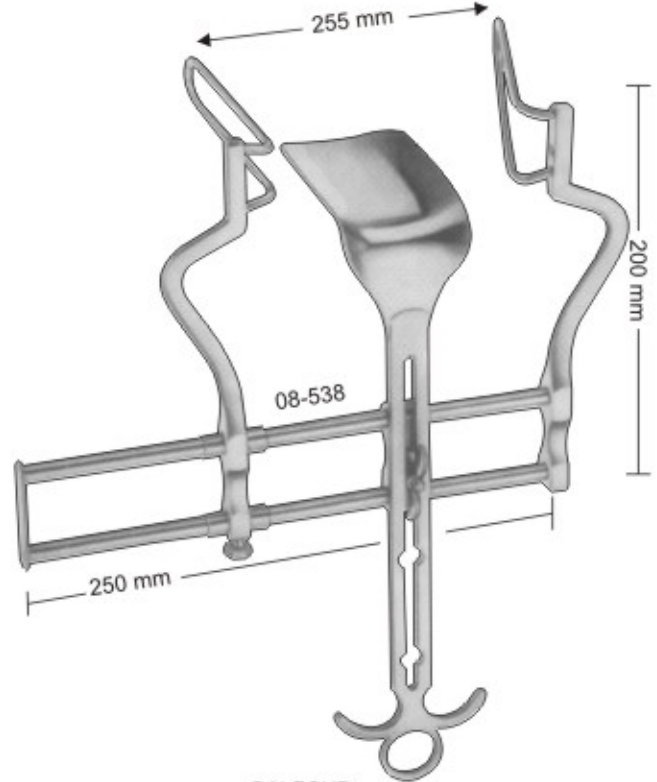

**BALFOUR**  
**19-791-000**  
Lateral blades 105 mm deep  
Center blade 107 x 80 mm

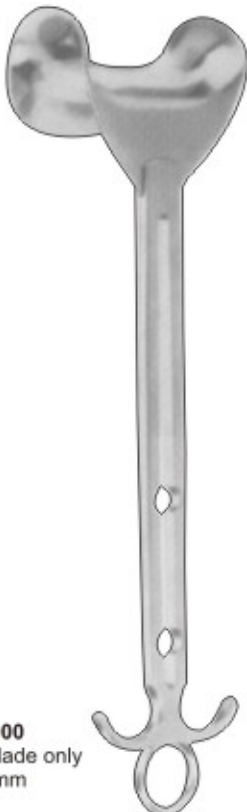

**19-792-000**  
Center blade only  
54 x 80 mm

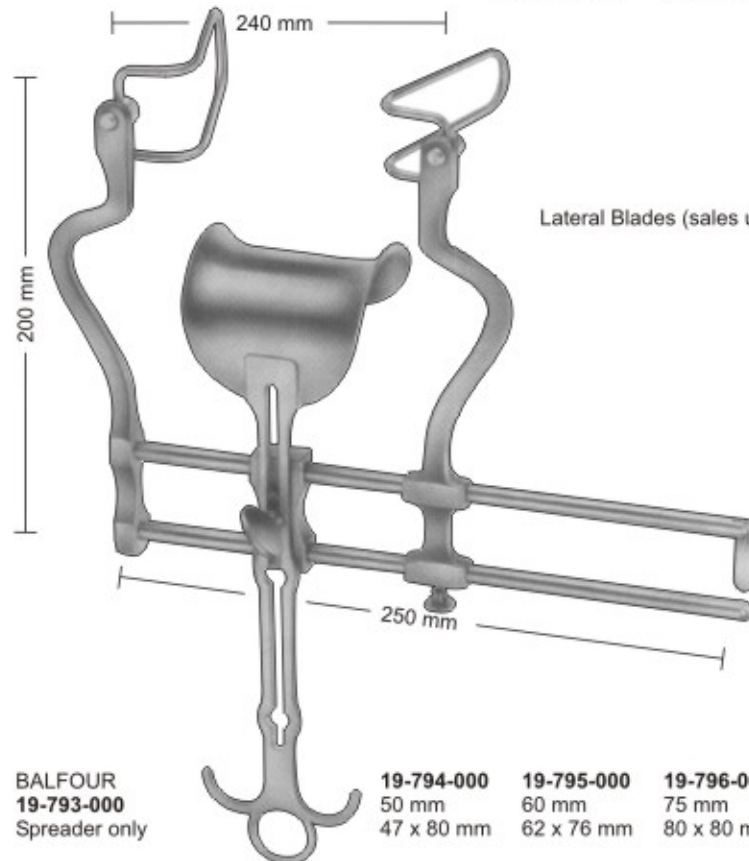

**BALFOUR**  
**19-793-000**  
Spreader only

Lateral Blades (sales unit of blades in pairs)

<b>19-794-000</b> 50 mm 47 x 80 mm	<b>19-795-000</b> 60 mm 62 x 76 mm	<b>19-796-000</b> 75 mm 80 x 80 mm	<b>19-797-000</b> 90 mm 80 x 80 mm
--	--	--	--





## RETRACTORS

Wundhaken  
Separadores

Ecarteurs  
Divaricatori

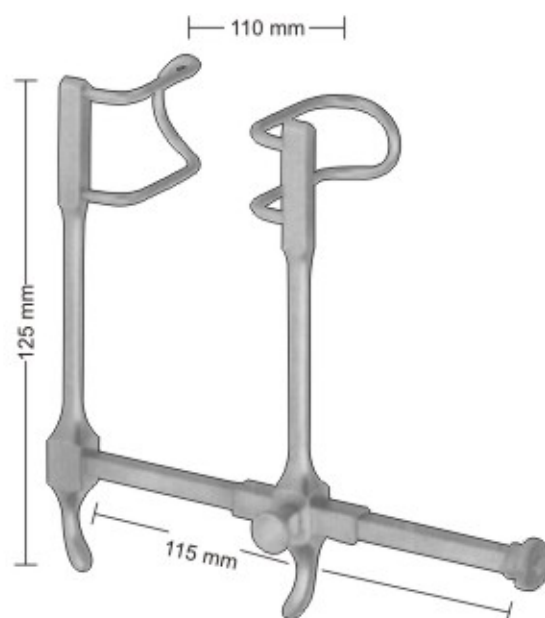

**GOSSET**  
19-798-000  
Blades: 38 mm deep

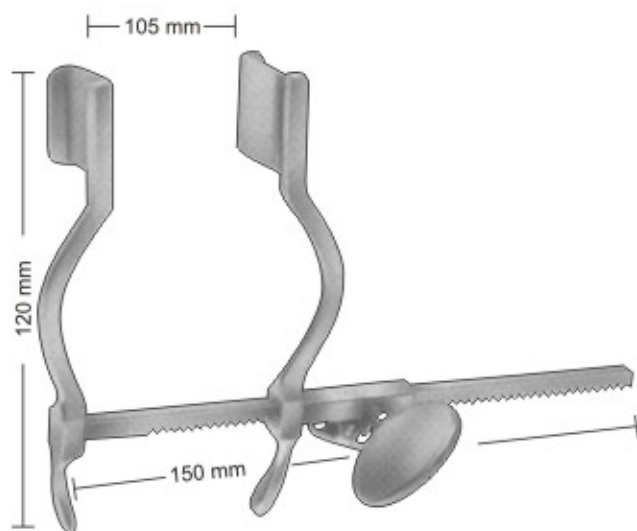

**HERTZLER**  
19-799-000  
Blades 20 x 25 mm

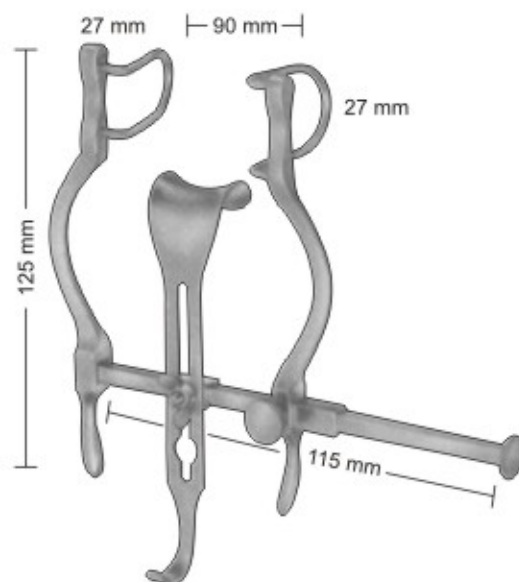

**BALFOUR-BABY**  
19-800-000  
Lateral Blades 27 mm deep  
Center blade 21 x 24 mm

# RETRACTORS



Wundhaken  
Separadores

Ecarteurs  
Divaricatori



### O'SULLIVAN/O'CONNOR

19-801-000 (Set includes frame & 3 blades)

19-802-000 Frame Only (not pictured)



19-803-000  
Single Retractor Blade  
110 x 70 mm



19-804-000  
Set of 2 Retractor Blade  
80 x 45 mm



19-805-000  
Center Blade  
45 x 80 mm  
70 x 85 mm



19-806-000  
Center Blade  
100 x 60 mm

Sizes of These Blades to  
Same as about Blades.

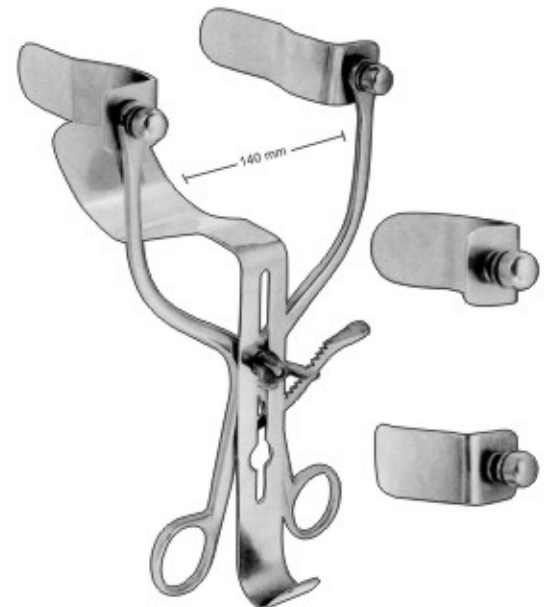

### COLLIN

- 19-807-250 Complete
- 19-808-001 Spreader only
- 19-809-002 Blades 55 x 25 mm
- 19-810-003 Blades 80 x 25 mm
- 19-811-004 Center Blade  
115 x 45 mm



## RETRACTORS

Wundhaken  
Separadores

Ecarteurs  
Divaricatori

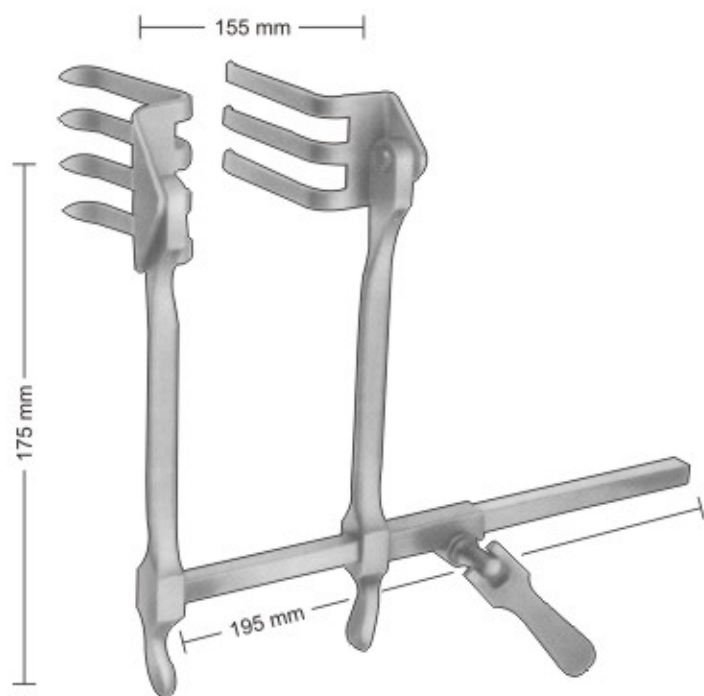

### SCOVILLE-RICHTER

**19-812-000** Complete with 1 pair blades.

**19-813-000** Frame only.

The Retractor bar and shanks may be easily rotated 180° when blades are in situ.



**19-814-000**  
62 x 52 mm



62 x 37 mm



**19-815-000**  
47 x 51 mm



**19-816-000**  
30 x 40 mm



**19-817-000**  
37 x 62 mm



**COLLIN**  
19-818-200 20 cm, 8"  
complete with 2 lateral  
blades and central blade



**LEGUEU**  
19-819-170  
17 cm, 6 3/4"



**DOYEN**  
19-820-280 48 mm x 90 mm  
19-821-280 48 mm x 105 mm  
19-822-280 48 mm x 120 mm  
19-823-280 48 mm x 135 mm  
28 cm, 11"



**ROCHARD**  
19-824-310 48 mm x 90 mm  
19-825-310 48 mm x 105 mm  
19-826-310 48 mm x 120 mm  
19-827-310 48 mm x 135 mm  
19-828-310 48 mm x 155 mm  
31 cm, 12"



# RETRACTORS

Wundhaken  
Separadores

Ecarteurs  
Divaricatori

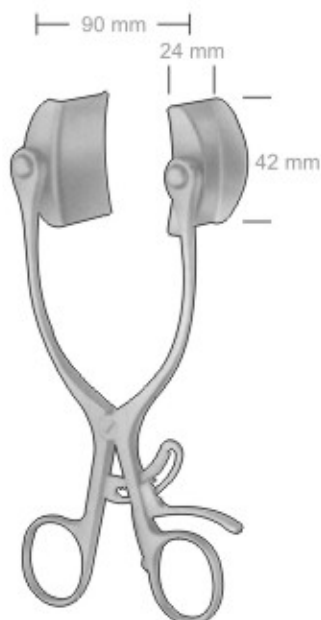

**BABY-COLLIN**  
19-829-000  
with 2 pair of blades

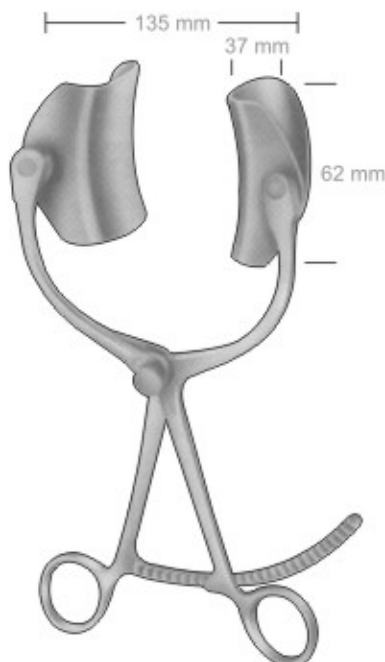

**COLLIN**  
19-830-000  
complete



**COLLIN**  
19-831-000  
Spreader Only

Lateral blade	<b>19-832-000</b> 37x62mm	<b>19-834-000</b> 37x80mm	<b>19-836-000</b> 37x98mm
Center blade	<b>19-833-000</b> 54x55mm	<b>19-835-000</b> 54x67mm	<b>19-837-000</b> 52x76mm



**RICARD**  
19-838-000 Complete  
19-839-000 Spreader only  
Lateral blade **19-840-000** 58x80mm  
**19-842-000** 72x84mm  
Center blade **19-841-000** 54x70mm  
**19-843-000** 72x90mm

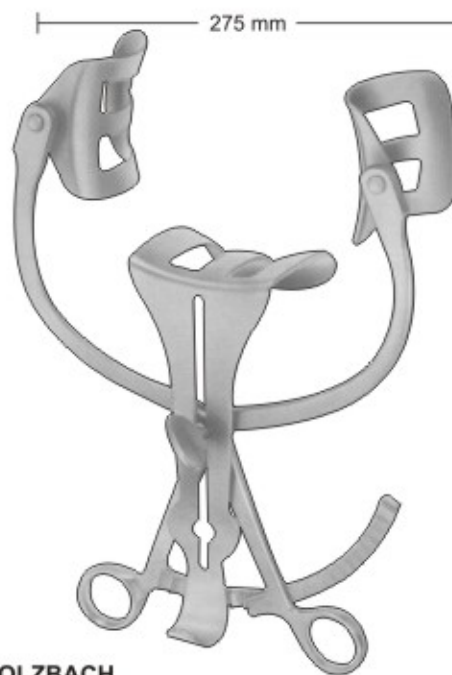

**HOLZBACH**  
19-844-000 Complete  
19-845-000 Spreader only  
19-846-000 Lateral blade 59x80mm  
19-847-000 Center blade 74x82mm



Wundhaken  
Separadores

Ecarteurs  
Divaricatori

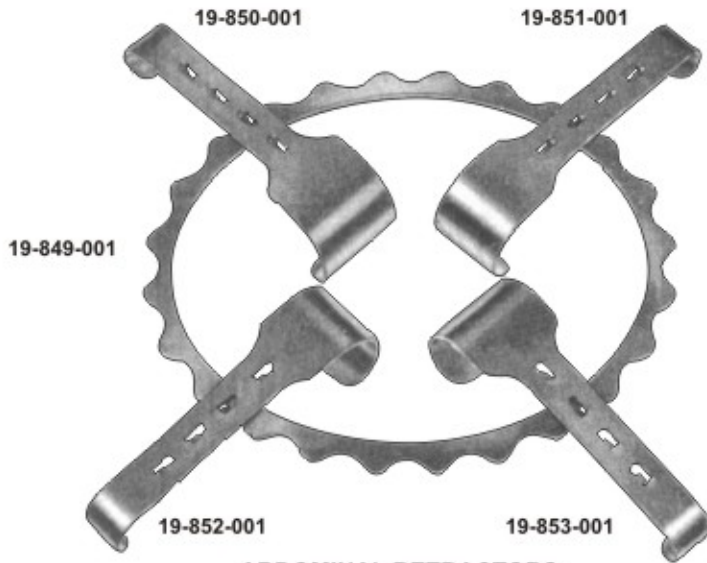

**ABDOMINAL RETRACTORS**  
for new-born and children

### DENIS-BROWNE

**19-848-001** Complete with 4 blades

**19-849-001** Frame 190 x 160 mm

**19-850-001** 2 blades only 40 x 30 mm

**19-851-001** 2 blades only 40 x 40 mm

**19-852-001**  
Blades only 20 x 30 mm



**19-853-001**  
Blades only 20 x 40 mm



**ABDOMINAL RETRACTORS**  
well suitable for gynaecologists

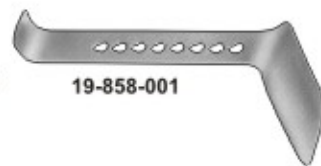

19-858-001

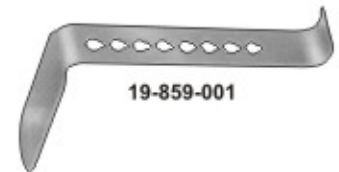

19-859-001

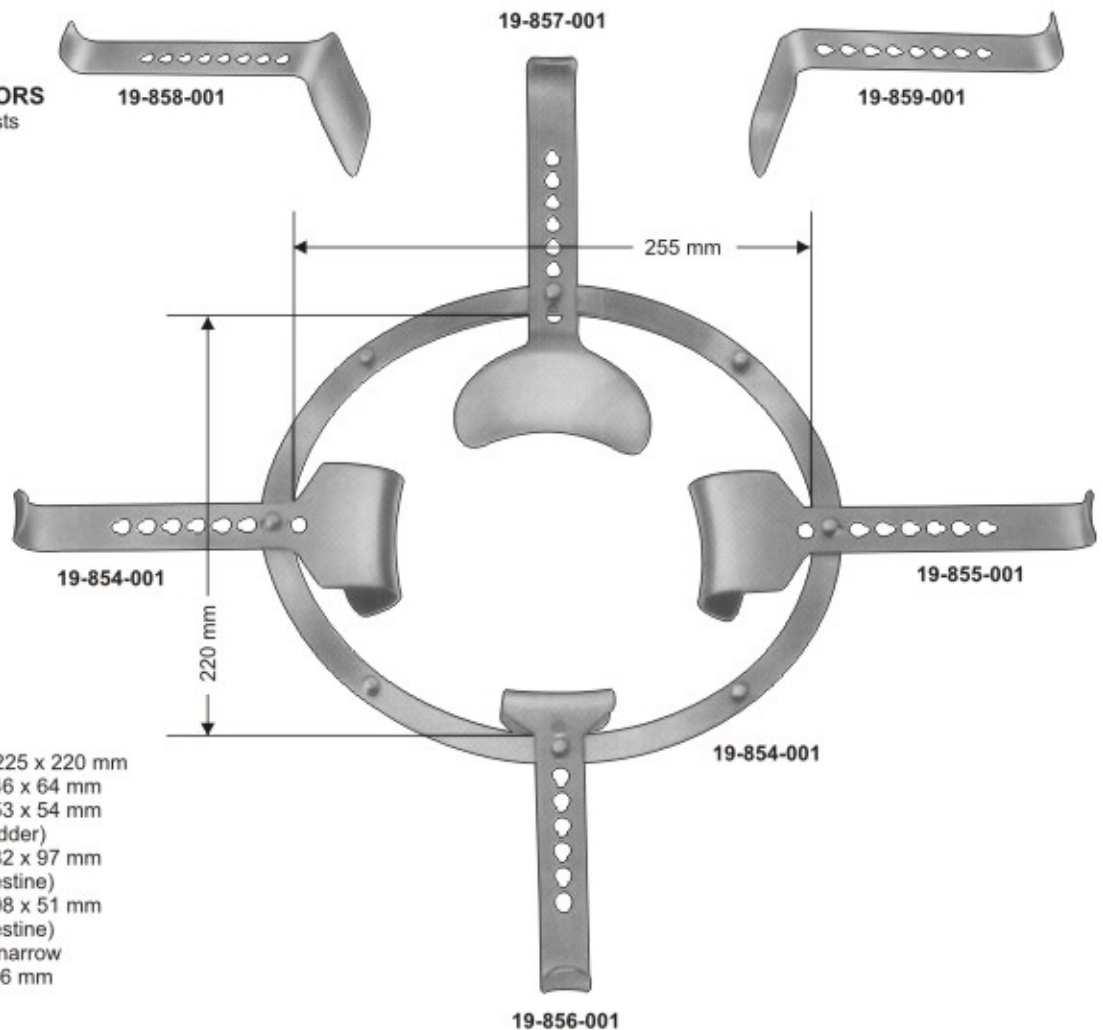

### SEMM

consisting of:

**19-854-001** 1 frame 225 x 220 mm

**19-855-001** 2 blade 46 x 64 mm

**19-856-001** 1 blade 53 x 54 mm

(for bladder)

**19-857-001** 1 blade 82 x 97 mm

(for intestine)

**19-858-001** 1 blade 98 x 51 mm

(for intestine)

**19-859-001** 1 blade, narrow

107 x 36 mm



# RETRACTORS

Wundhaken  
Separadores

Ecarteurs  
Divaricatori

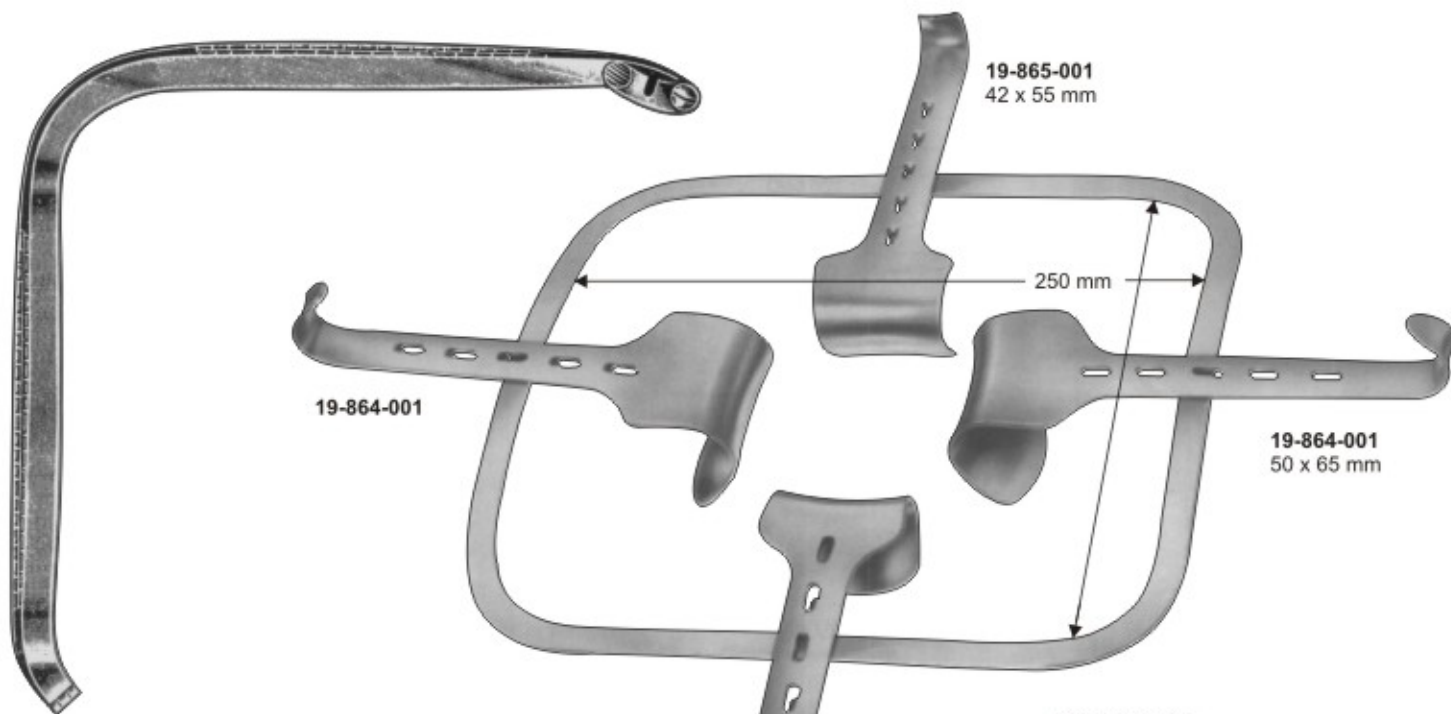

19-865-001  
42 x 55 mm

19-864-001

250 mm

19-864-001  
50 x 65 mm

19-865-001

**KIRSCHNER**  
19-860-001  
with folding frame &  
2 blades of each 19-864-001 &  
19-865-001

**KIRSCHNER**  
19-861-001  
with vaulted fixed frame &  
2 blades of each 19-864-001 &  
19-865-001

19-862-001  
300 x 380 mm  
Frame only, over-sized

19-863-001  
320 x 300 mm  
Frame only

Additional valves for corpulent persons



**KIRSCHNER**  
19-866-001  
64 x 80 mm

**KIRSCHNER-BALFOUR**  
19-867-001  
80 x 82 mm

**KIRSCHNER**  
19-868-001 90 x 69 mm  
19-869-001 92 x 95 mm  
19-870-001 78 x 58 mm

**KIRSCHNER**  
19-871-001 108 x 42 mm  
19-872-001 91 x 55 mm  
19-873-001 121 x 55 mm



Wundhaken  
Separadores

Ecarteurs  
Divaricatori

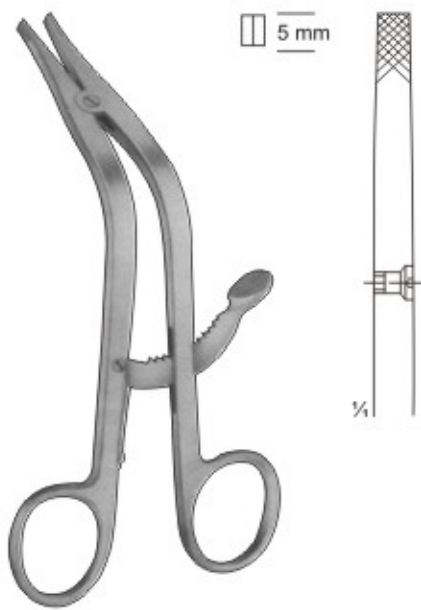

**CLOWARD**  
19-874-155  
15.5 cm, 6"



**CLOWARD**  
19-875-135  
13.5 cm, 5 1/4"

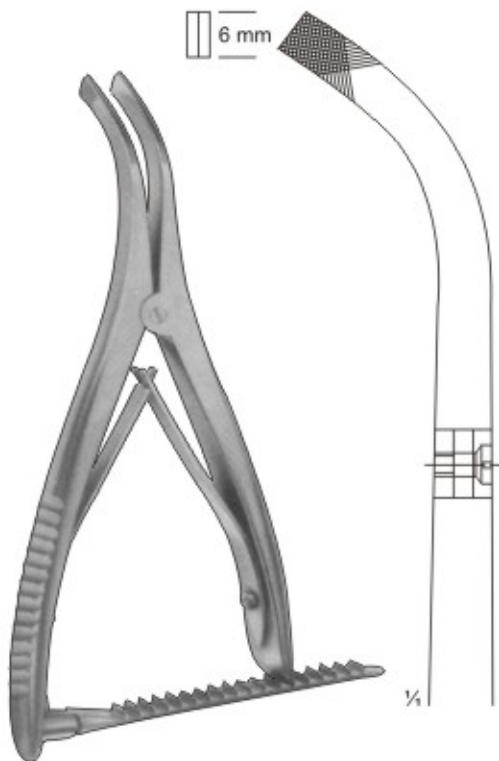

**INGE**  
19-876-170  
17.0 cm, 6 3/4"

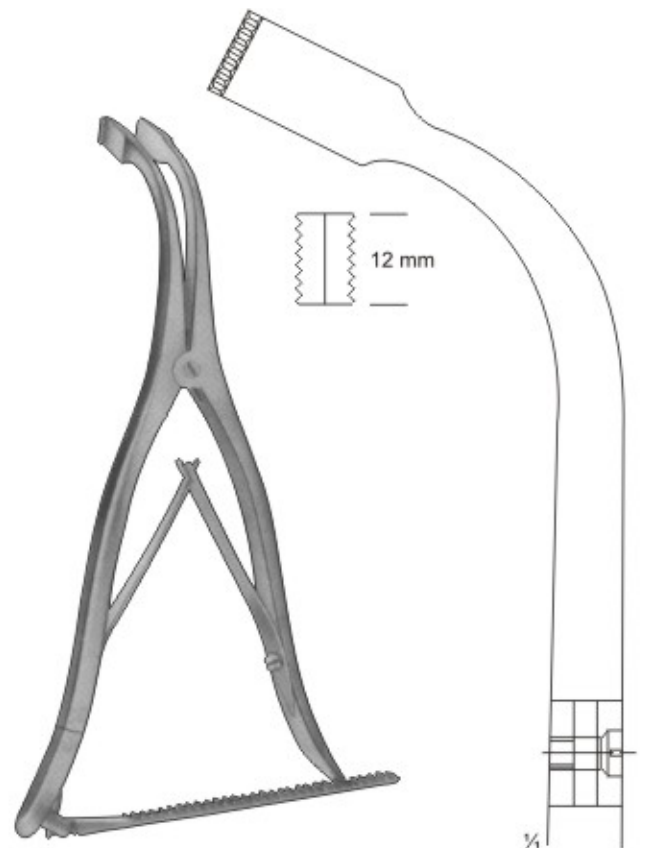

**INGE**  
19-877-275  
27.5 cm, 10 3/4"





# CARDIOVASCULAR & THORACIC INSTRUMENTS

---

- **CARDIOVASCULAR FORCEPS**
- **RIB CONTRACTORS**
- **RIB SPREADERS**
- **RIB SHEARS & CHISELS**
- **VARICOSE VEIN SETS**

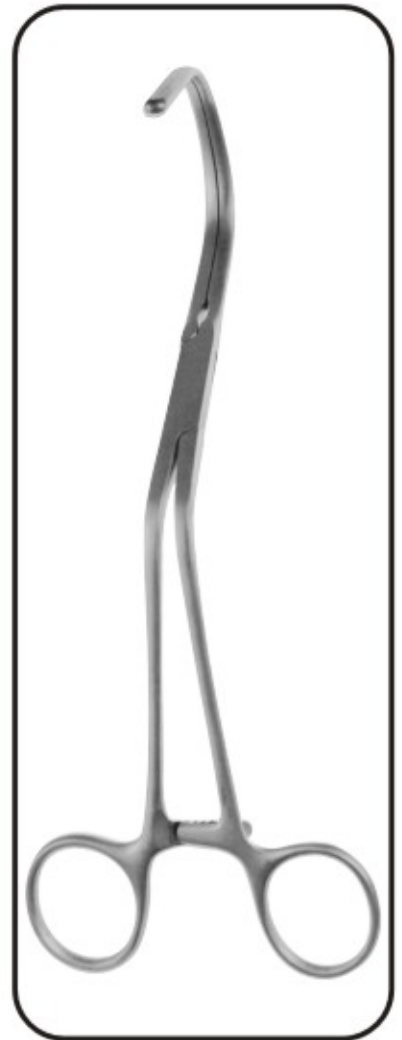

# THORACIC/CARDIOVASCULAR

Thorax-cardiovasculaire  
Thorax-cardiovasculair

Torace-cardiovascolare  
Torax-cardiovascular

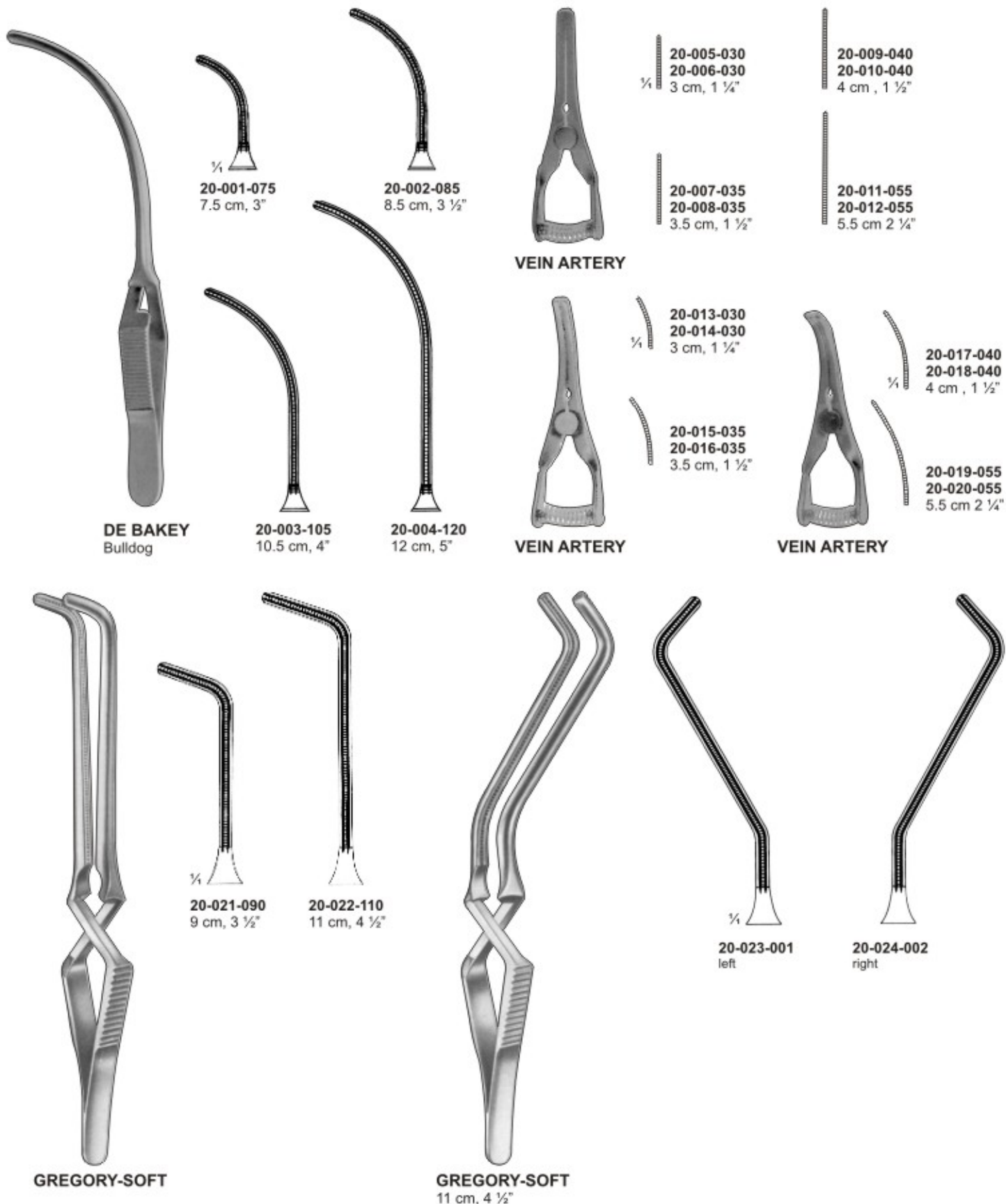



## THORACIC/CARDIOVASCULAR

Thorax-cardiovasculaire  
Thorax-cardiovasculair

Torace-cardiovascolare  
Torax-cardiovascular



DEBAKEY

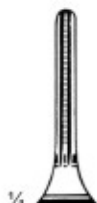

¼  
**20-025-080**  
8 cm, 3 ¼"  
Jaw 20 mm  
Straight

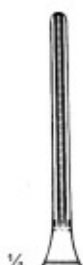

¼  
**20-026-090**  
9 cm, 3 ½"  
Jaw 30 mm  
Straight

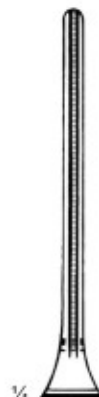

¼  
**20-027-105**  
10.5 cm, 4"  
Jaw 45 mm  
Straight



¼  
**20-028-125**  
12.5 cm, 5"  
Jaw 68 mm  
Straight



DEBAKEY



¼  
**20-029-075**  
7.5 cm, 3"  
Jaw 20 mm  
Curved



¼  
**20-030-085**  
8.5 cm, 3 ½"  
Jaw 30 mm  
Curved



¼  
**20-031-095**  
9.5 cm, 3 ¾"  
Jaw 45 mm  
Curved



¼  
**20-032-115**  
11.5 cm, 4 ¾"  
Jaw 68 mm  
Curved

# THORACIC/CARDIOVASCULAR

Thorax-cardiovasculaire  
Thorax-cardiovasculair

Torace-cardiovascolare  
Torax-cardiovascular



**DIEFFENBACH**



**20-033-038**  
3.8 cm, 1 1/2"



**20-034-038**  
3.8 cm, 1 1/2"



**20-035-051**  
5.1 cm, 2"



**20-036-060**  
6 cm, 2 1/2"



**20-037-060**  
6 cm, 2 1/2"



**20-038-060**  
6 cm, 2 1/2"



**DIETRICH**



**20-039-049**  
4.9 cm, 2"  
Jaw 8 mm  
Straight



**20-040-053**  
5.3 cm, 2"  
Jaw 12 mm  
Straight



**20-041-059**  
5.9 cm, 2 1/2"  
Jaw 20 mm  
Straight



**20-042-043**  
4.3 cm, 1 3/4"  
Jaw 8 mm  
Curved



**20-043-045**  
4.5 cm, 1 3/4"  
Jaw 12 mm  
Curved



**20-044-050**  
5 cm, 2"  
Jaw 20 mm  
Curved



**BULLDOG CLAMP**



**20-045-043**  
4.3 cm, 1 3/4"  
Jaw 13 mm  
Curved



**20-046-049**  
4.9 cm, 2"  
Jaw 18 mm  
Curved



**20-047-054**  
5.4 cm, 2 1/4"  
Jaw 20 mm  
Curved



# THORACIC/CARDIOVASCULAR

Thorax-cardiovasculaire  
Thorax-cardiovasculair

Torace-cardiovascolare  
Torax-cardiovascular



**WICKHAM MINI**



**20-048-049**  
4.9 cm, 2"  
Jaw 13 mm  
Straight



**20-049-054**  
5.4 cm, 2 1/4"  
Jaw 18 mm  
Straight



**20-050-061**  
6.1 cm, 2 1/2"  
Jaw 25 mm  
Straight



**20-051-047**  
4.7 cm, 2"  
Jaw 10 mm  
Curved



**20-052-051**  
5.1 cm, 2"  
Jaw 18 mm  
Curved



**20-053-055**  
5.5 cm, 2 1/4"  
Jaw 25 mm  
Curved

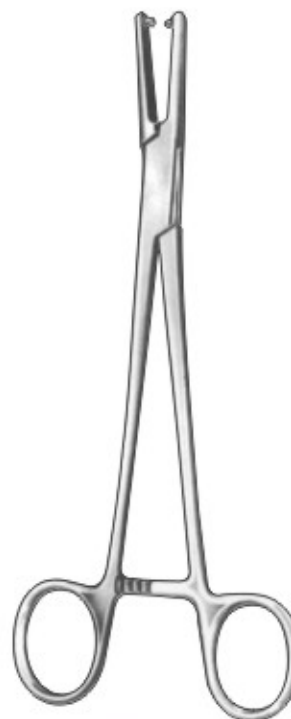

**WICKHAM**  
**20-054-240**  
24 cm, 9 1/2"



**DEBAKEY-DIETRICH**



**20-055-047**  
4.7 cm, 2"  
Jaw 10 mm  
Straight



**20-056-051**  
5.1 cm, 2"  
Jaw 14 mm  
Straight



**20-057-057**  
5.7 cm, 2 1/4"  
Jaw 20 mm  
Straight



**20-058-044**  
4.4 cm, 1 3/4"  
Jaw 10 mm  
Curved



**20-059-046**  
4.6 cm, 1 3/4"  
Jaw 14 mm  
Curved



**20-060-049**  
4.9 cm, 2"  
Jaw 20 mm  
Curved



**20-061-054**  
5.4 cm, 2 1/4"  
Jaw 20 mm  
Curved



**JOHN-HOPKINS**  
**20-062-245**  
24.5 cm, 9 3/4"

# THORACIC/CARDIOVASCULAR

Thorax-cardiovasculaire  
Thorax-cardiovasculair

Torace-cardiovascolare  
Torax-cardiovascular



**OCHSNER**  
20-063-235  
23.5 cm, 9 1/4"

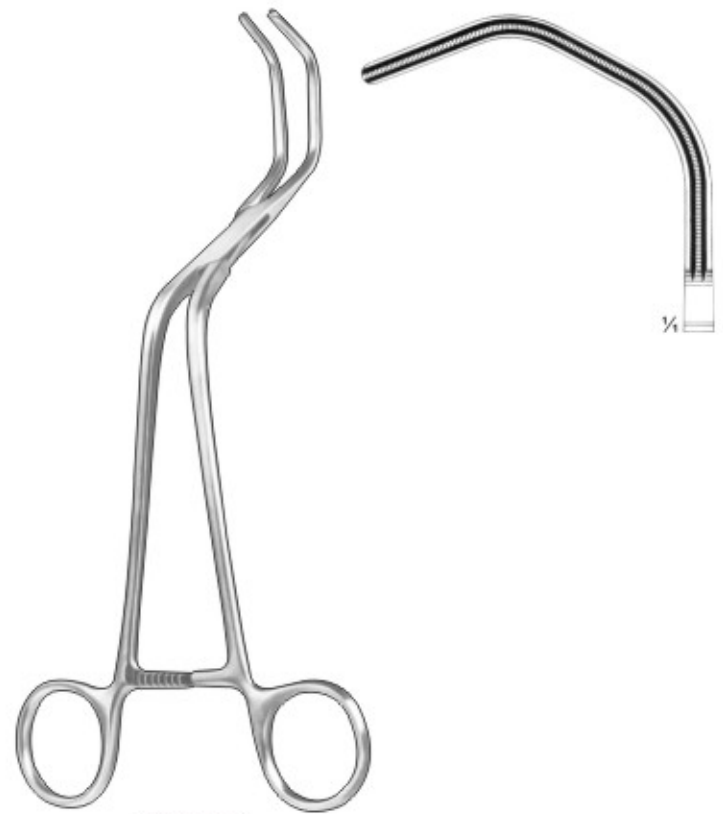

**DIETRICH**  
20-064-210  
21 cm, 8 1/4"

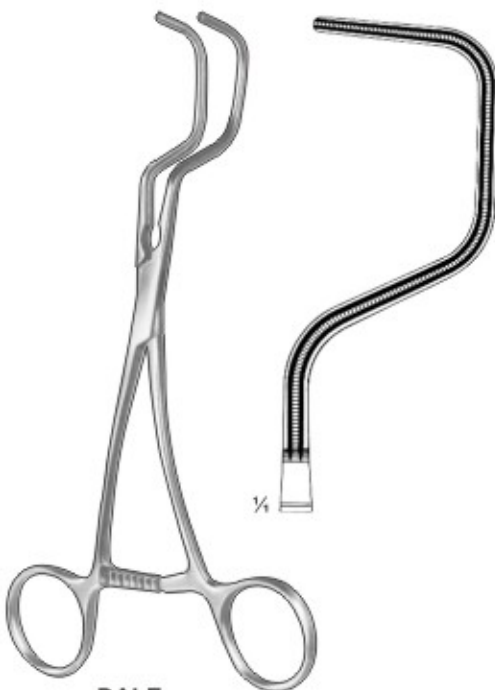

**DALE**  
20-065-185  
18.5 cm, 7 1/4"

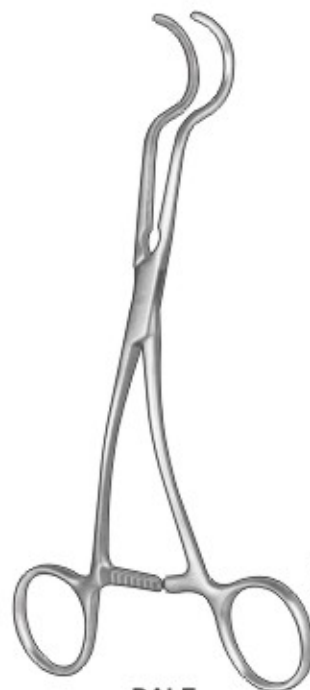

**DALE**



**20-066-170**  
17 cm, 6 1/2"



**20-067-180**  
18 cm, 7"



**20-068-185**  
18.5 cm, 7 1/4"



## THORACIC/CARDIOVASCULAR

Thorax-cardiovasculaire  
Thorax-cardiovasculair

Torace-cardiovascolare  
Torax-cardiovascular



**GREGORY**



20-069-140  
14 cm, 5 1/2"

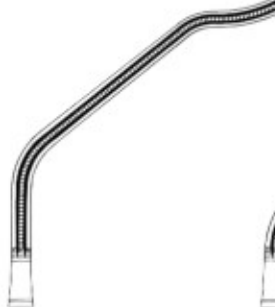

20-070-160  
16 cm, 6 1/4"



20-071-180  
18 cm, 7"

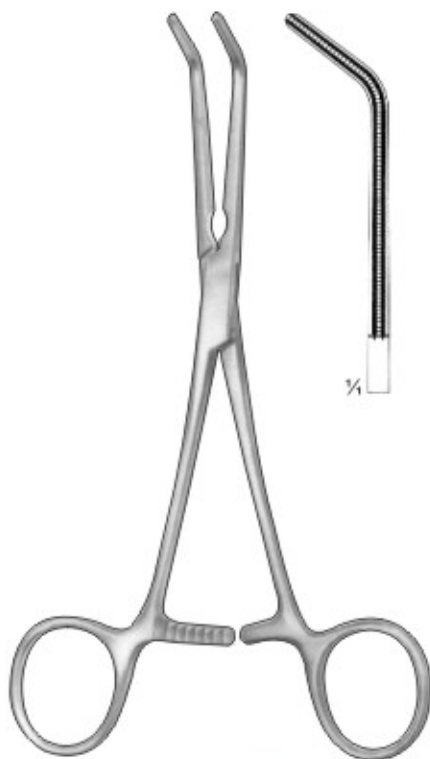

**HUSFELDT**  
20-072-175  
17.5 cm, 7"

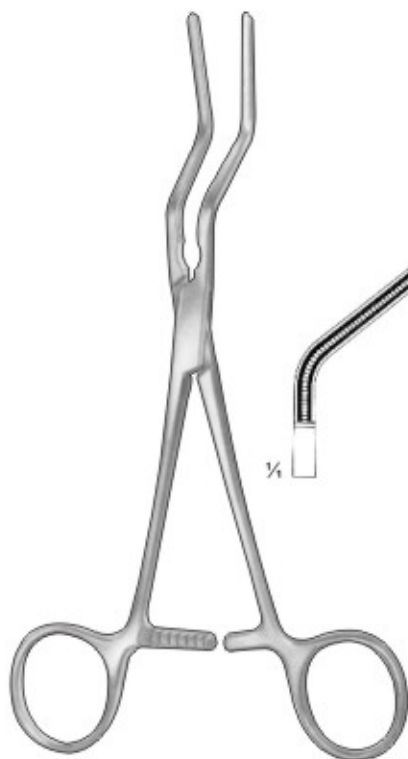

**HUSFELDT**  
20-073-175  
17.5 cm, 7"

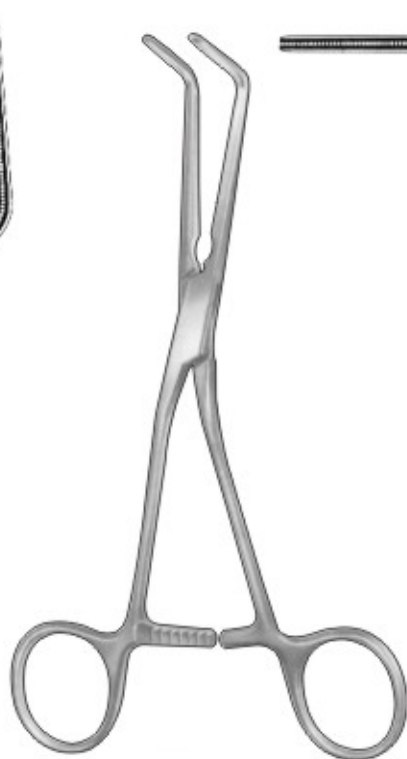

**HUSFELDT**  
20-074-170  
17 cm, 6 3/4"

# THORACIC/CARDIOVASCULAR

Thorax-cardiovasculaire  
Thorax-cardiovasculair

Torace-cardiovascolare  
Torax-cardiovascular

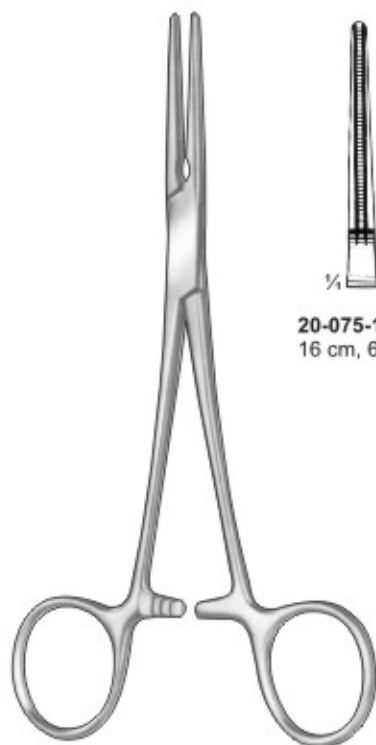

**20-075-160**  
16 cm, 6 1/4"

**DE BAKEY - RANKIN**



**20-076-160**  
16 cm, 6 1/4"



**20-077-150**  
15 cm, 6"

**DE BAKEY - MOSQUITO**



**20-078-150**  
15 cm, 6"

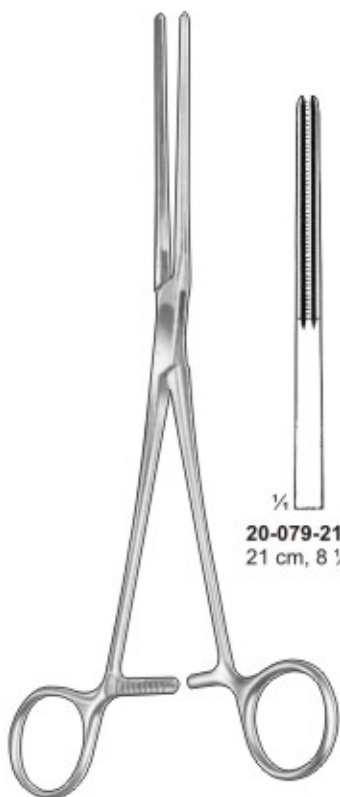

**20-079-210**  
21 cm, 8 1/4"

**POTTS**



**20-080-220**  
22 cm, 8 3/4"



**POTTS**  
**20-081-220**  
22 cm, 8 3/4"

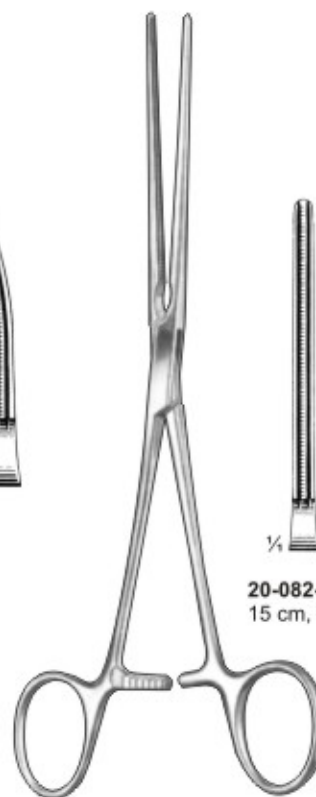

**20-082-150**  
15 cm, 6"

**BAINBRIDGE**



**20-083-180**  
18 cm, 7"





## THORACIC/CARDIOVASCULAR

Thorax-cardiovasculaire  
Thorax-cardiovasculair

Torace-cardiovascolare  
Torax-cardiovascular

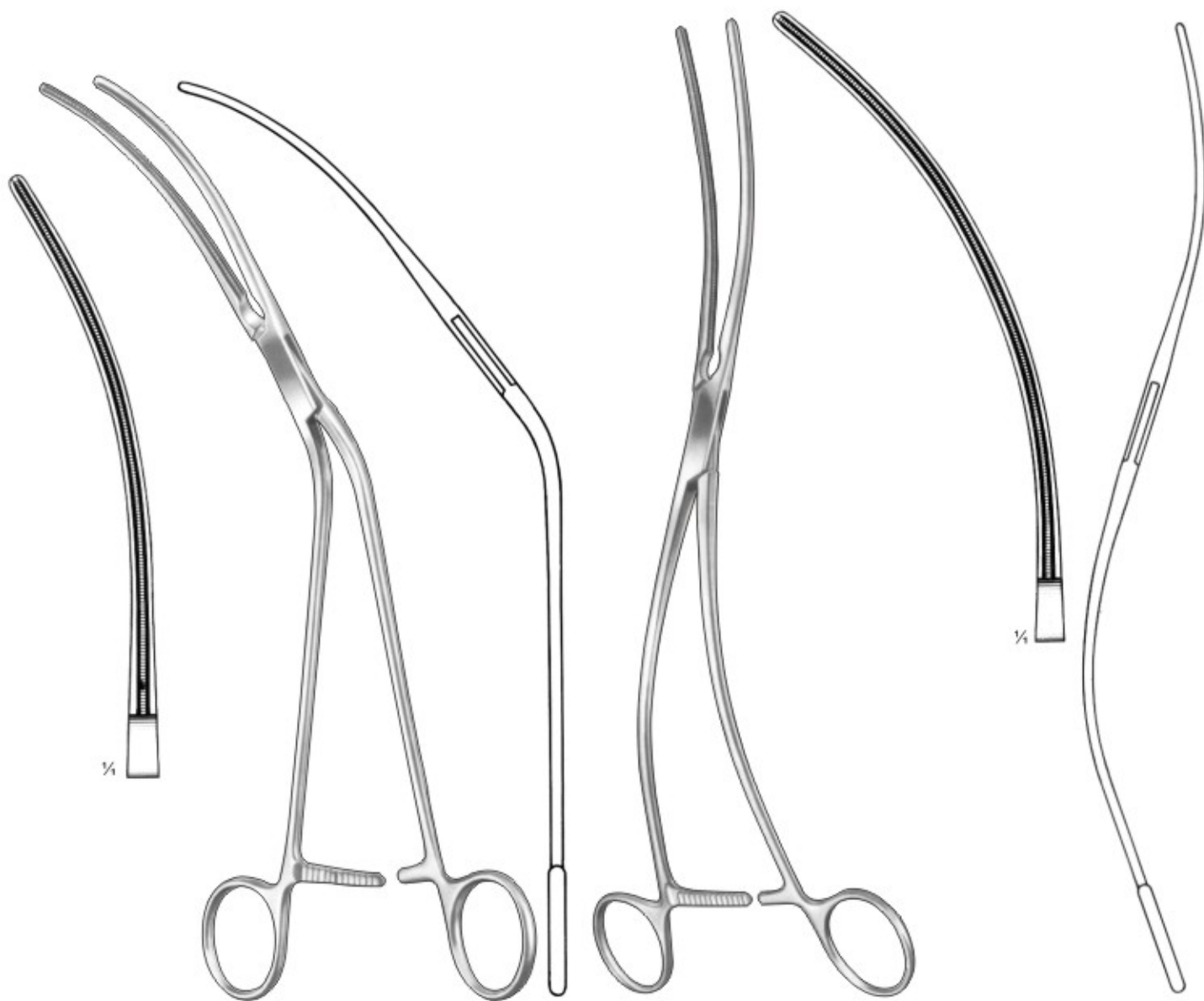

**DE BAKEY**  
20-084-280  
28 cm, 11"

**DE BAKEY**  
20-085-300  
30 cm, 11 3/4"

# THORACIC/CARDIOVASCULAR

Thorax-cardiovasculaire  
Thorax-cardiovasculair

Torace-cardiovascolare  
Torax-cardiovascular



**WEBER**  
20-086-260  
26 cm, 10 1/4"  
left



**WEBER**  
20-087-260  
26 cm, 10 1/4"  
right



## THORACIC/CARDIOVASCULAR

Thorax-cardiovasculaire  
Thorax-cardiovasculair

Torace-cardiovascolare  
Torax-cardiovascular

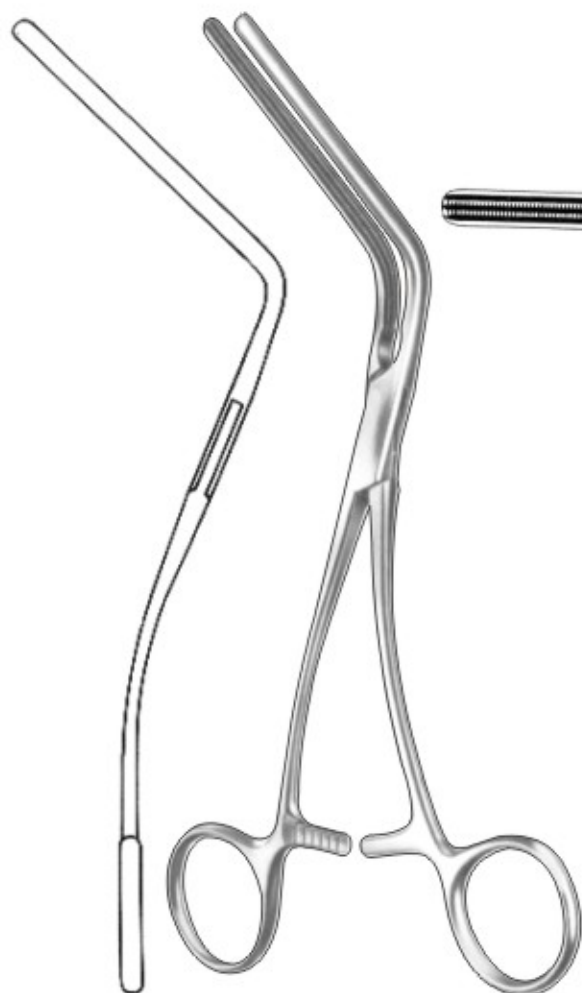

**MORRIS-DE BAKEY**



$\frac{1}{4}$   
**20-088-180**  
18 cm, 7"

**20-089-200**  
20 cm, 8"



**20-090-230**  
23 cm, 9"

**20-091-250**  
25 cm, 10"

# THORACIC/CARDIOVASCULAR

Thorax-cardiovasculaire  
Thorax-cardiovasculair

Torace-cardiovascolare  
Torax-cardiovascular



DE BAKEY - BAHNSON



$\frac{1}{4}$   
**20-092-230**  
23 cm, 9"

**20-093-240**  
24 cm, 9 ½"

**20-094-250**  
25 cm, 10"



## THORACIC/CARDIOVASCULAR

Thorax-cardiovasculaire  
Thorax-cardiovasculair

Torace-cardiovascolare  
Torax-cardiovascular



**DE BAKEY**  
20-095-100  
10 cm, 4"



**DE BAKEY**  
20-096-110  
11 cm, 4 1/4"

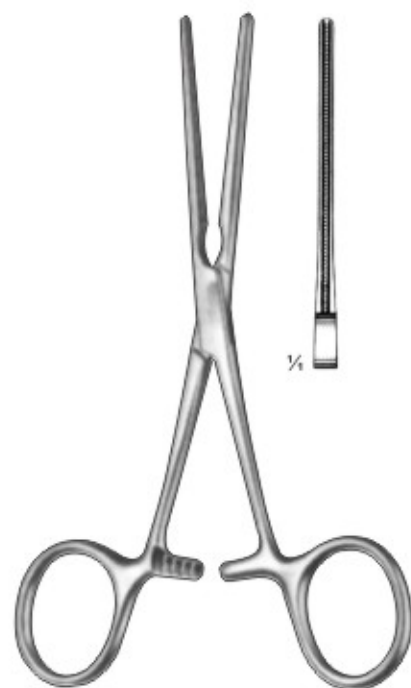

**DE BAKEY**  
20-097-120  
12 cm, 4 1/2"

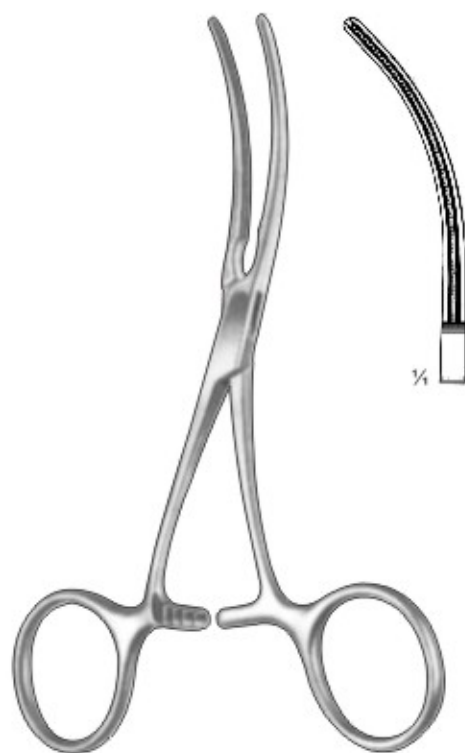

**DE BAKEY**  
20-098-120  
12 cm, 4 3/4"



**DE BAKEY**  
20-099-130  
13 cm, 5 1/4"

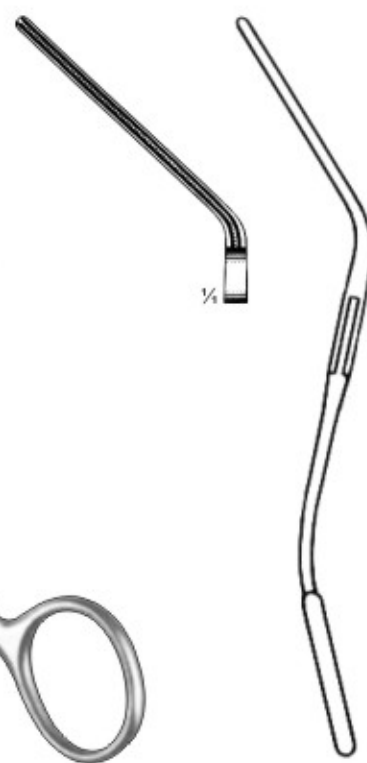

# THORACIC/CARDIOVASCULAR

Thorax-cardiovasculaire  
Thorax-cardiovasculair

Torace-cardiovascolare  
Torax-cardiovascular

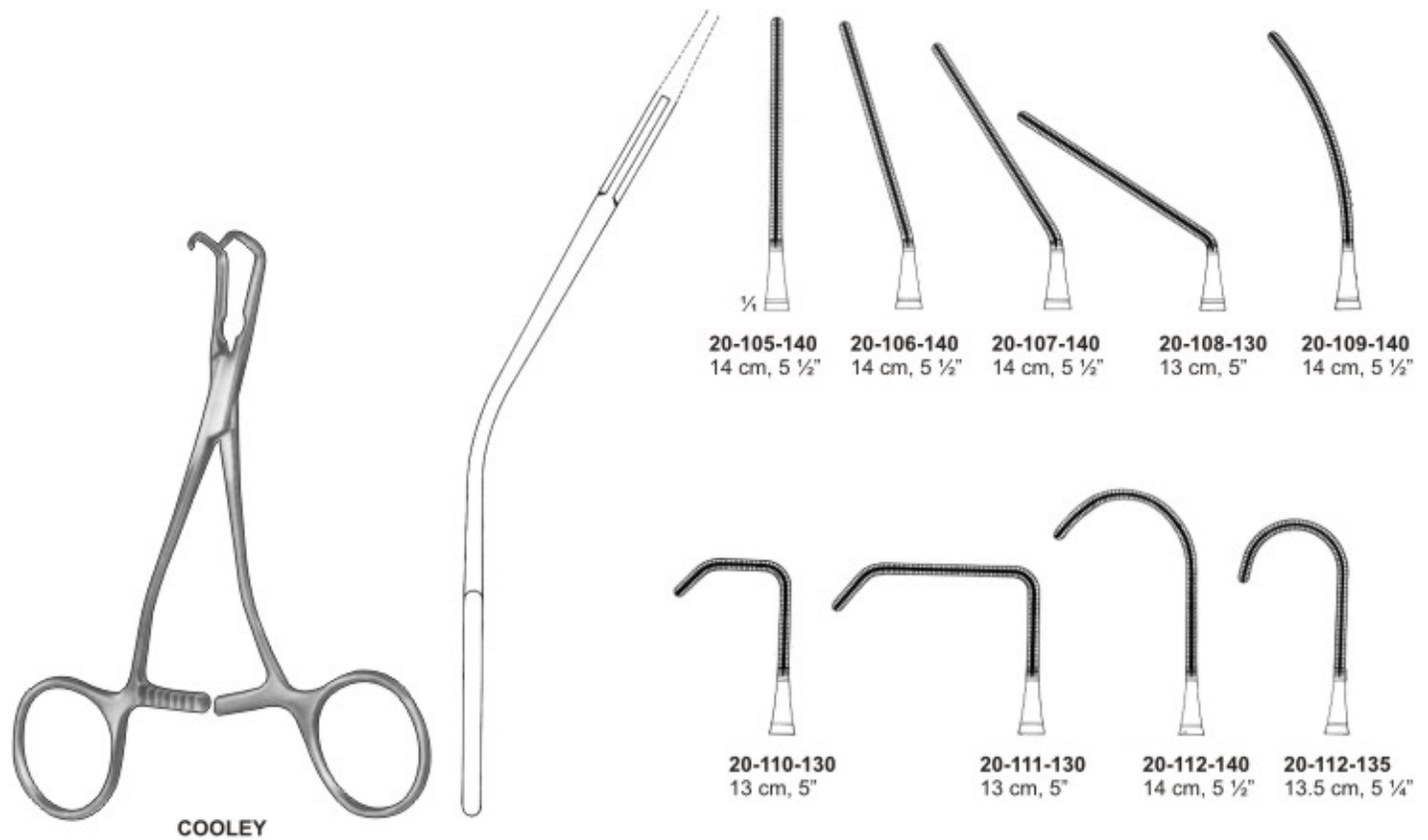
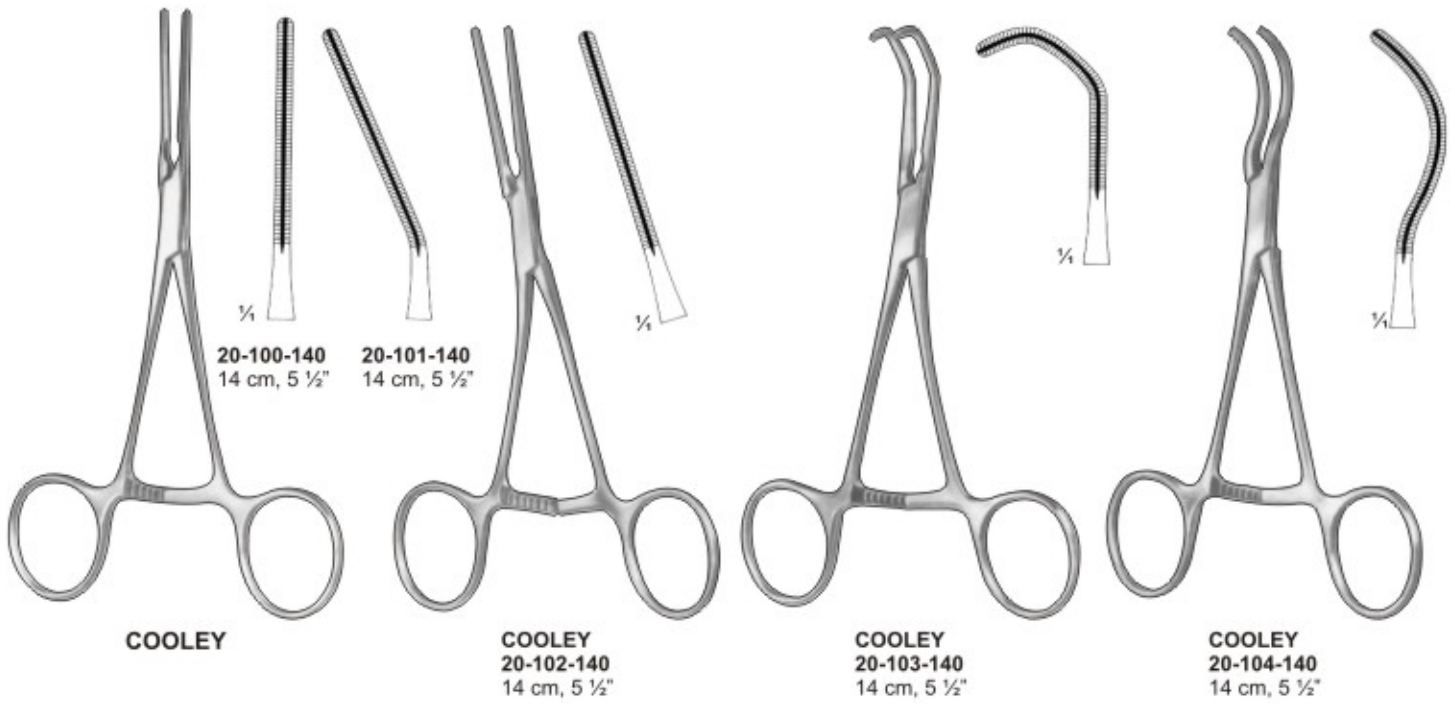



## THORACIC/CARDIOVASCULAR

Thorax-cardiovasculaire  
Thorax-cardiovasculair

Torace-cardiovascolare  
Torax-cardiovascular

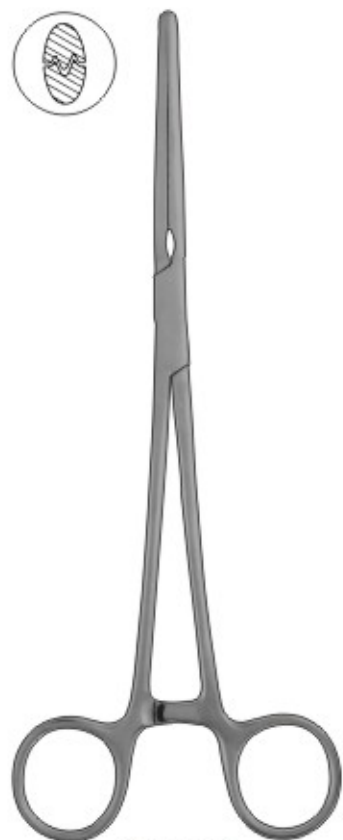

GLOVER

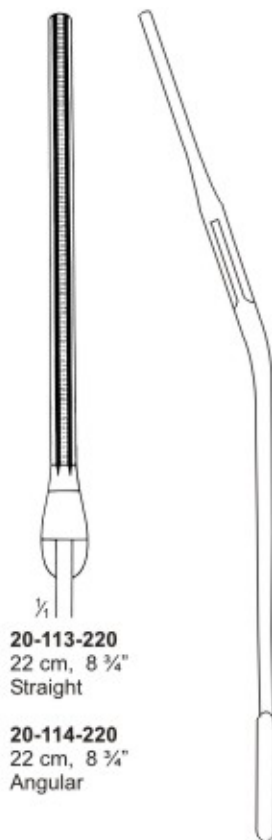

20-113-220  
22 cm, 8 3/4"  
Straight

20-114-220  
22 cm, 8 3/4"  
Angular



DE BAKAY

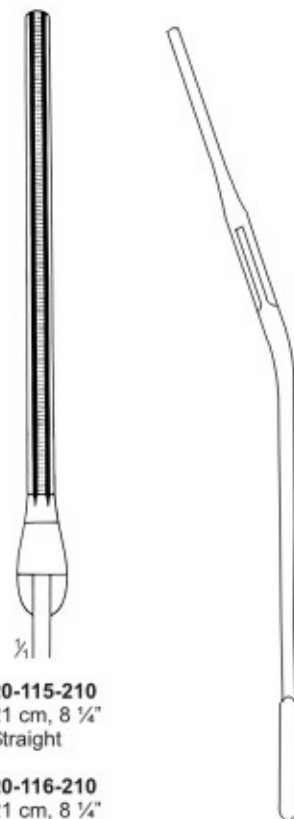

20-115-210  
21 cm, 8 1/4"  
Straight

20-116-210  
21 cm, 8 1/4"  
Angular



DE BAKAY

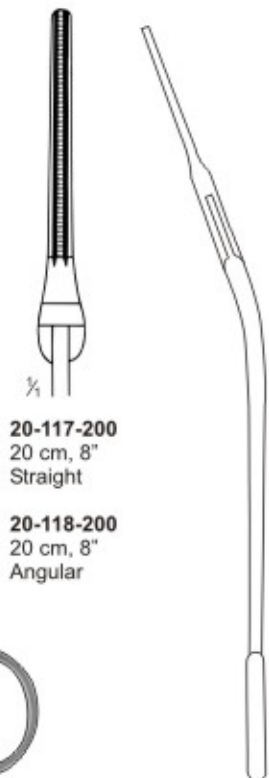

20-117-200  
20 cm, 8"  
Straight

20-118-200  
20 cm, 8"  
Angular



GLOVER

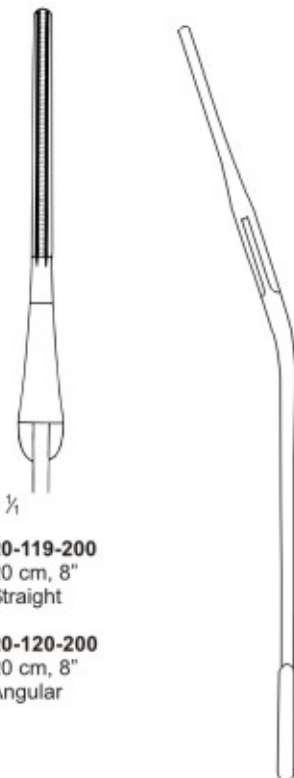

20-119-200  
20 cm, 8"  
Straight

20-120-200  
20 cm, 8"  
Angular

# THORACIC/CARDIOVASCULAR

Thorax-cardiovasculaire  
Thorax-cardiovasculair

Torace-cardiovascolare  
Torax-cardiovascular

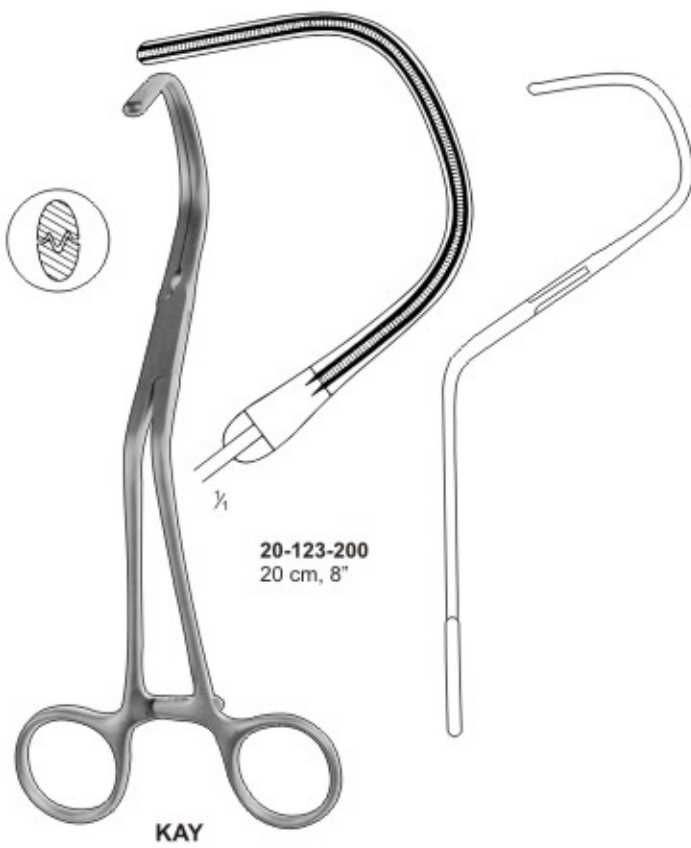
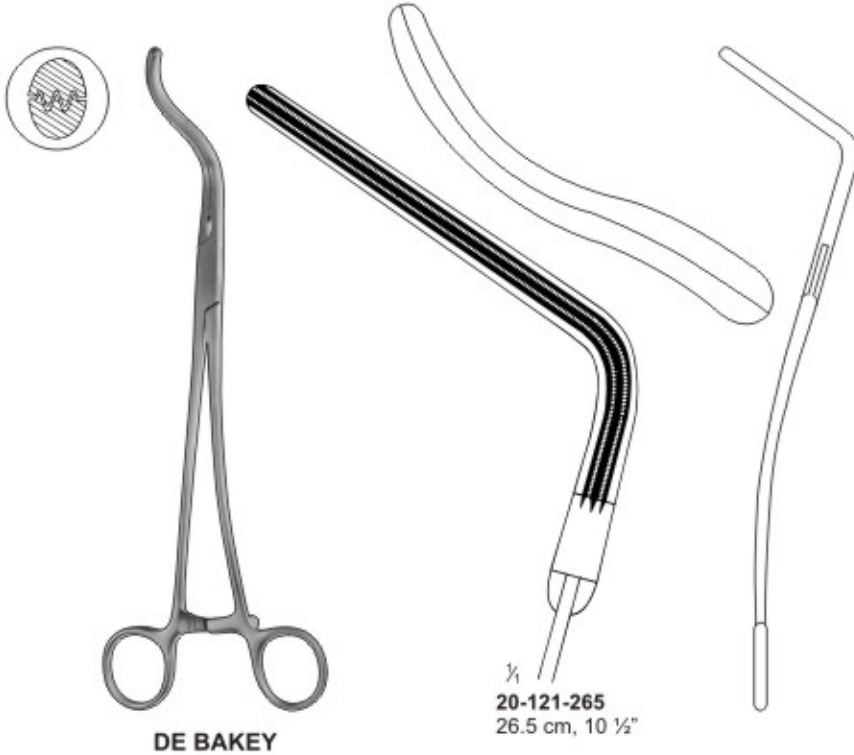





# THORACIC/CARDIOVASCULAR

Thorax-cardiovasculaire  
Thorax-cardiovasculair

Torace-cardiovascolare  
Torax-cardiovascular

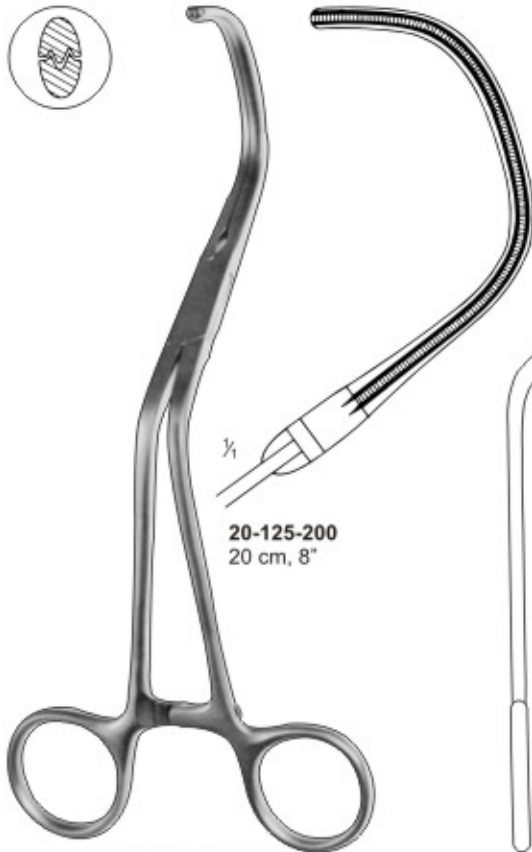

20-125-200  
20 cm, 8"

LAMBERT-KAY

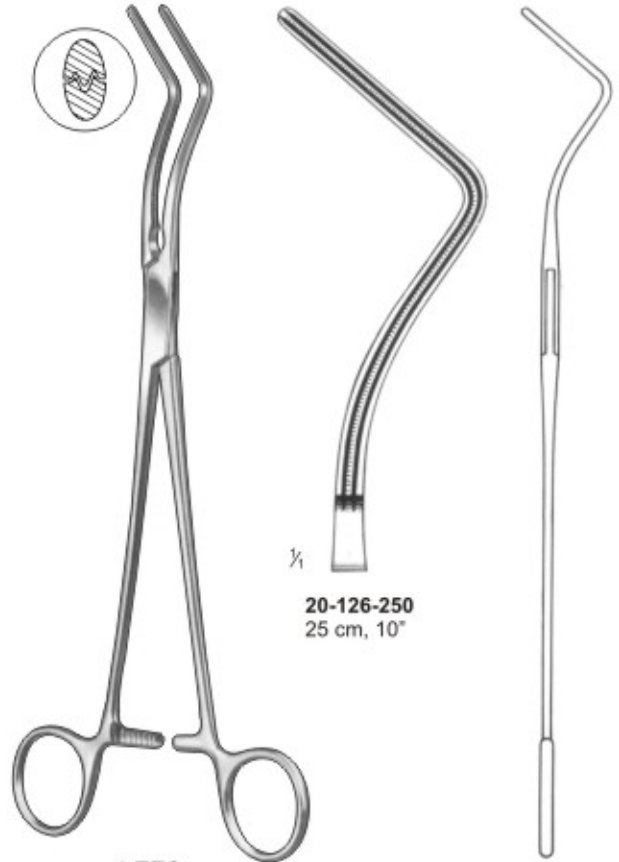

20-126-250  
25 cm, 10"

LEES  
Double Bent



20-127-280 28 cm, 11"  
20-128-300 30 cm, 12"  
20-129-320 32 cm, 12 1/2"  
20-130-340 34 cm, 13 1/2"

DE BAKEY

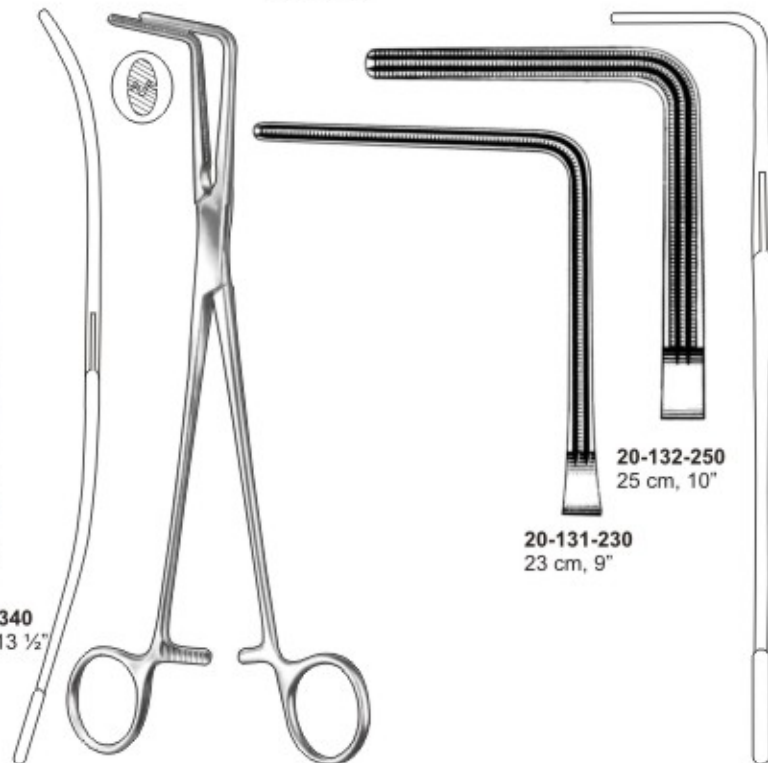

20-131-230 23 cm, 9"  
20-132-250 25 cm, 10"

LEES  
Right Angled Jaws

# THORACIC/CARDIOVASCULAR



Thorax-cardiovasculaire  
Thorax-cardiovascular

Torace-cardiovascolare  
Torax-cardiovascular

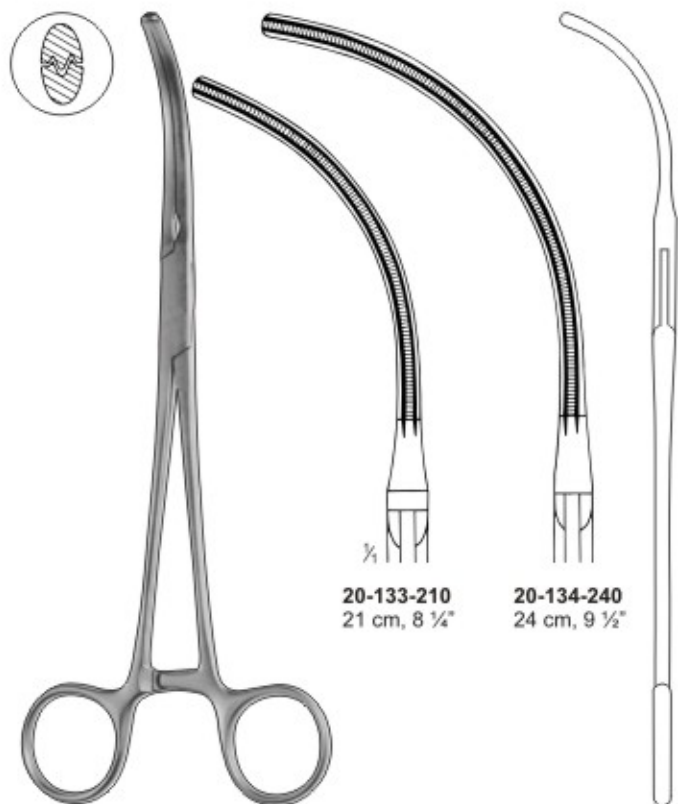

20-133-210  
21 cm, 8 1/4"

20-134-240  
24 cm, 9 1/2"

GLOVER

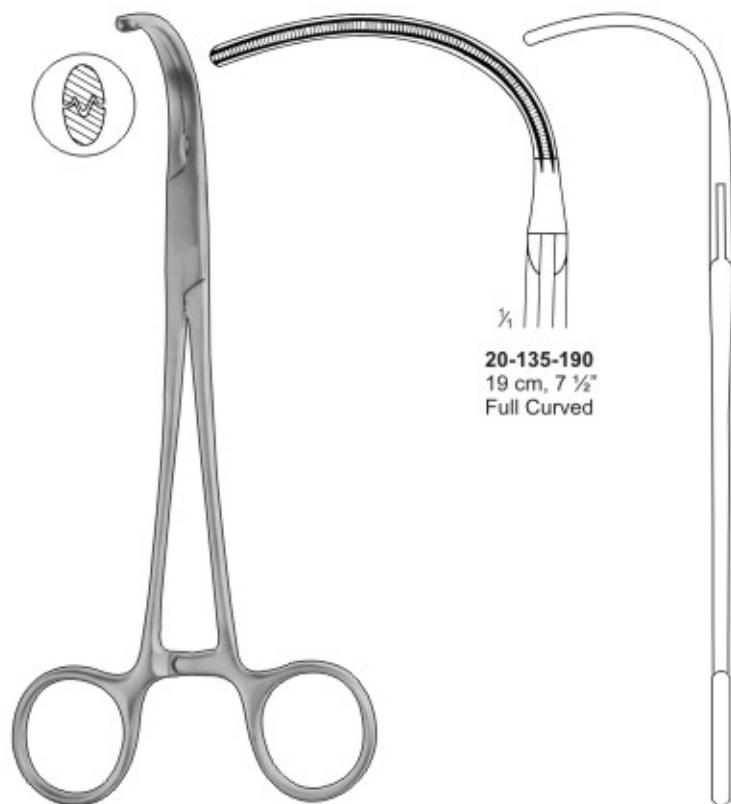

20-135-190  
19 cm, 7 1/2"  
Full Curved

GLOVER

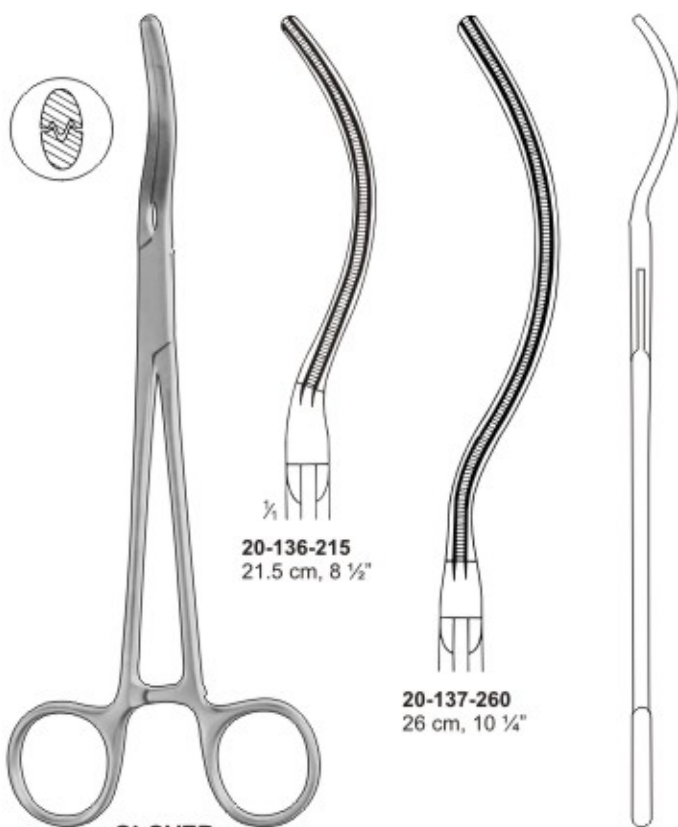

20-136-215  
21.5 cm, 8 1/2"

20-137-260  
26 cm, 10 1/4"

GLOVER  
spoon-shaped



20-138-260  
26 cm, 10 1/4"

DE BAKAY



## THORACIC/CARDIOVASCULAR

Thorax-cardiovasculaire  
Thorax-cardiovasculair

Torace-cardiovascolare  
Torax-cardiovascular

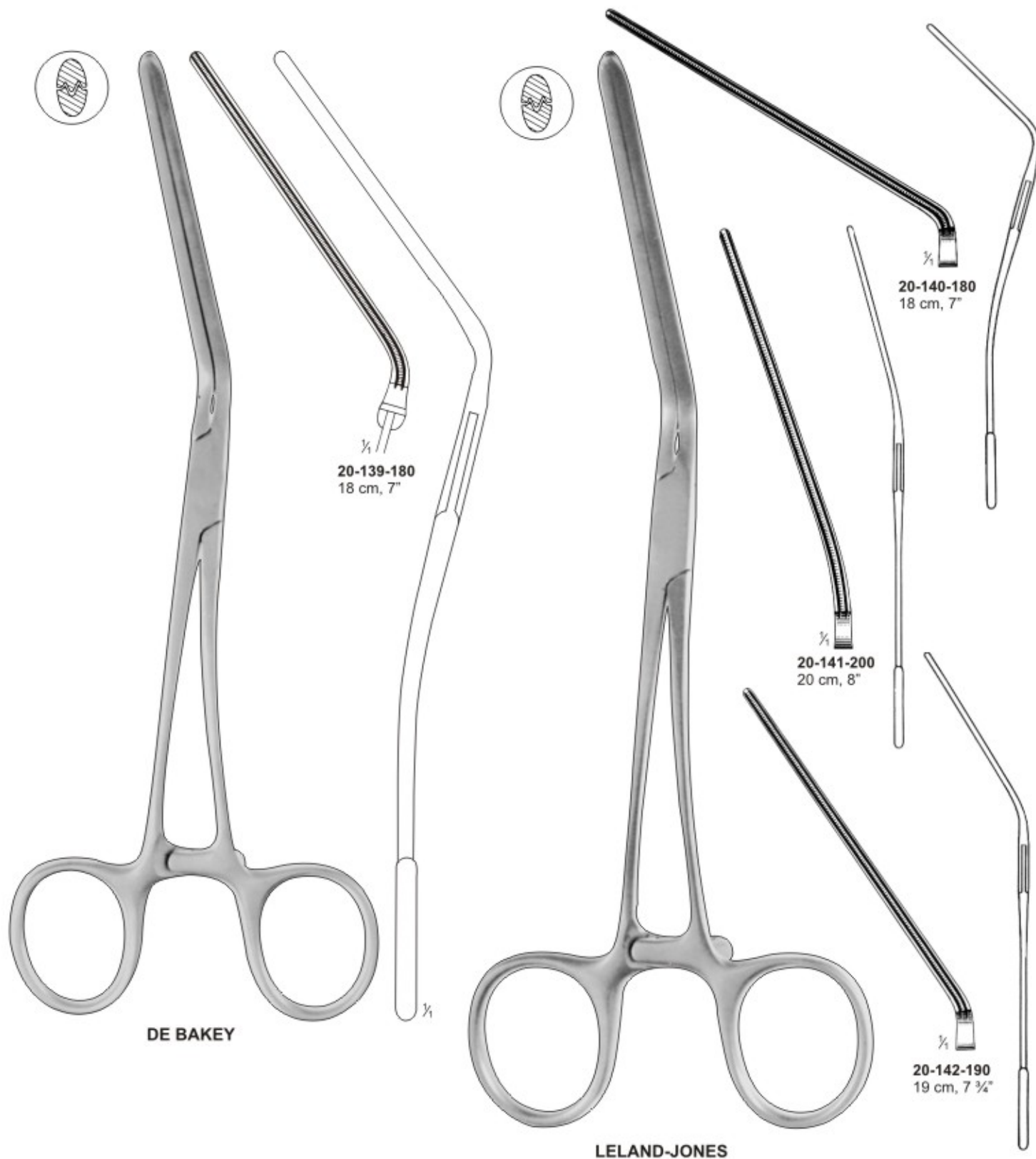

# THORACIC/CARDIOVASCULAR

Thorax-cardiovasculaire  
Thorax-cardiovasculair

Torace-cardiovascolare  
Torax-cardiovascular

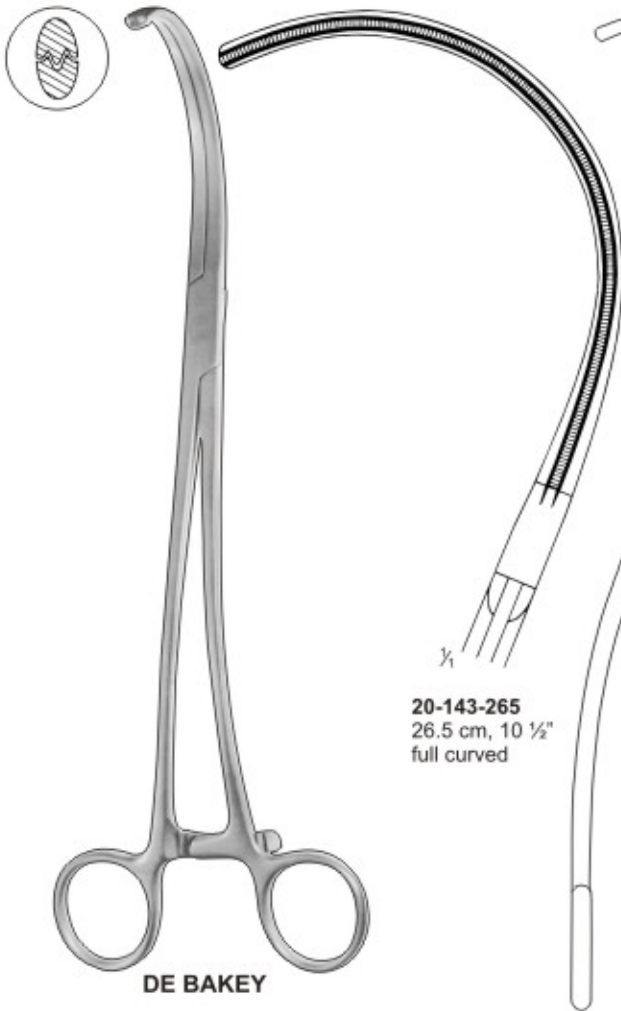

20-143-265  
26.5 cm, 10 1/2"  
full curved

DE BAKEY

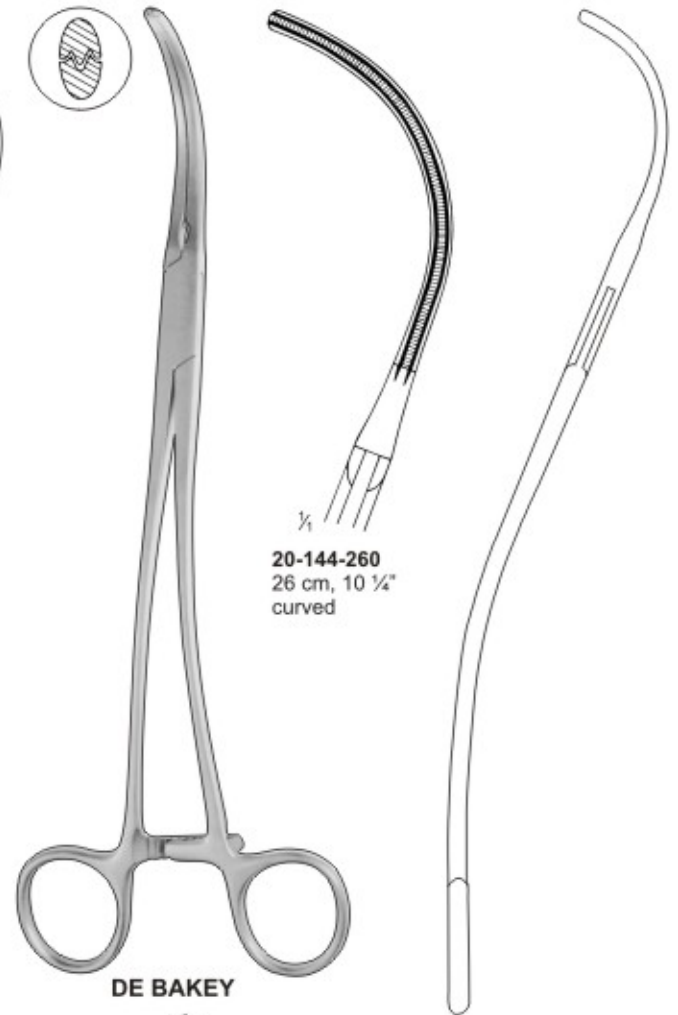

20-144-260  
26 cm, 10 1/4"  
curved

DE BAKEY



20-145-150  
15 cm, 6"

DE BAKEY

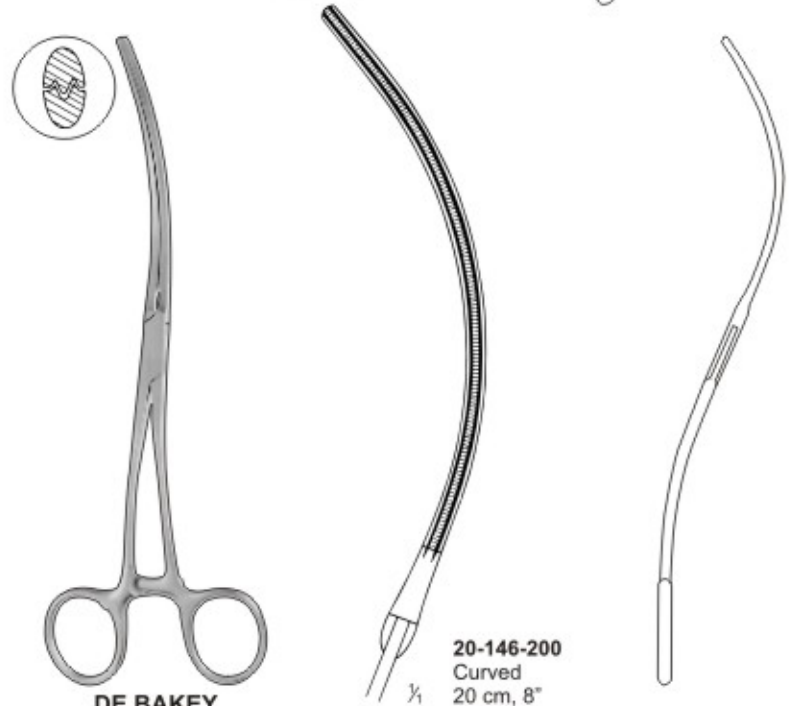

20-146-200  
Curved  
20 cm, 8"

DE BAKEY



## THORACIC/CARDIOVASCULAR

Thorax-cardiovasculaire  
Thorax-cardiovasculair

Torace-cardiovascolare  
Torax-cardiovascular

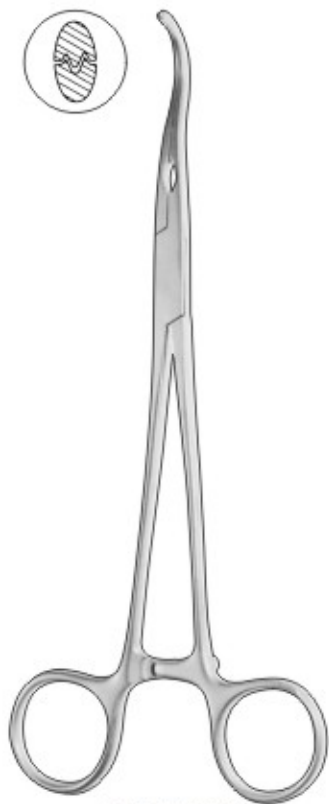

**DE BAKEY**  
Ligature Carrier



**20-147-210**  
21 cm, 8 1/4"



**20-148-240**  
24 cm, 9 1/2"

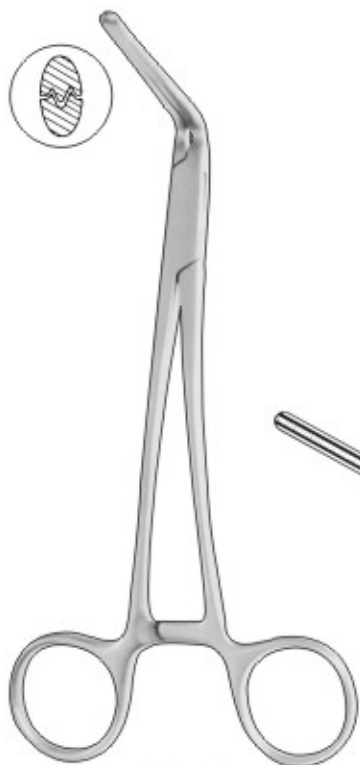

**DE BAKEY**  
Right Angled Jaws



**20-149-200**  
20 cm, 8"



**20-150-190**  
19 cm, 7 1/2"

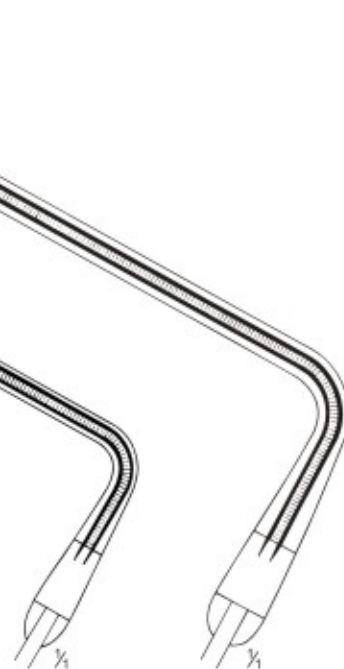

**20-151-220**  
22 cm, 8 3/4"

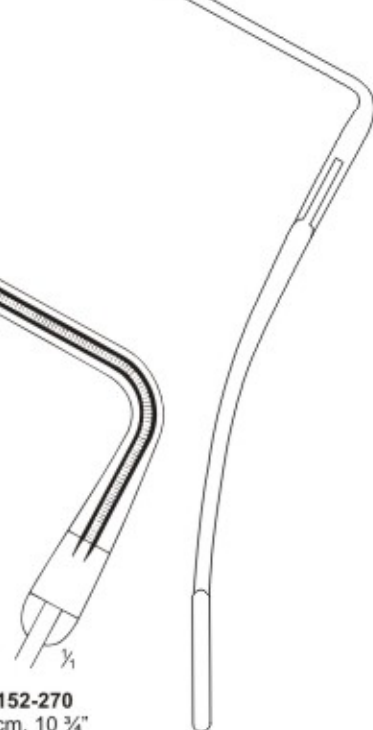

**20-152-270**  
27 cm, 10 1/4"

# THORACIC/CARDIOVASCULAR

Thorax-cardiovasculaire  
Thorax-cardiovasculair

Torace-cardiovascolare  
Torax-cardiovascular



60° angled jaws



**DE BAKAY**

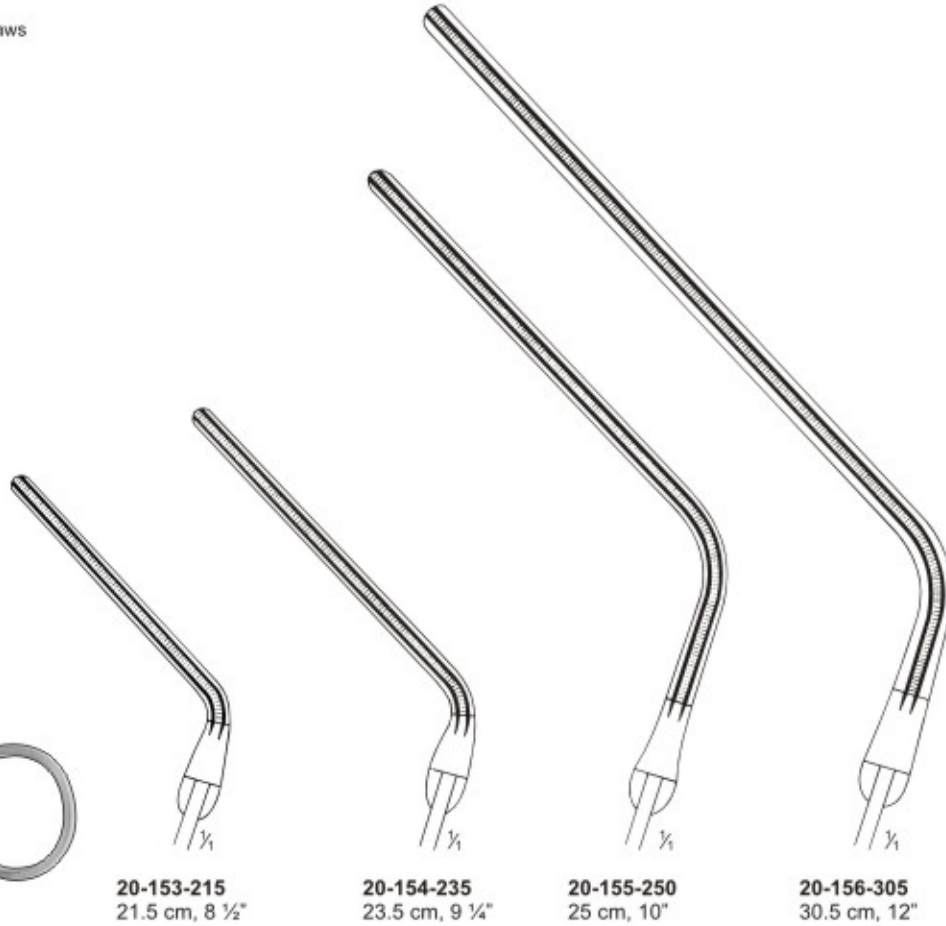

**20-153-215**  
21.5 cm, 8 1/2"

**20-154-235**  
23.5 cm, 9 1/4"

**20-155-250**  
25 cm, 10"

**20-156-305**  
30.5 cm, 12"



**DE BAKAY**

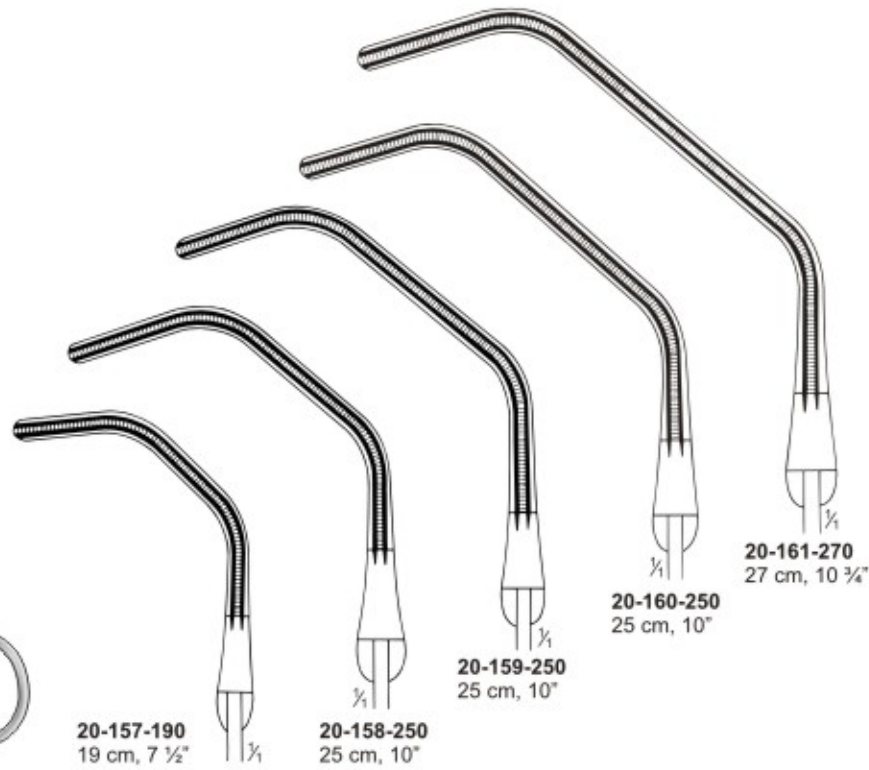

**20-157-190**  
19 cm, 7 1/2"

**20-158-250**  
25 cm, 10"

**20-159-250**  
25 cm, 10"

**20-160-250**  
25 cm, 10"

**20-161-270**  
27 cm, 10 1/4"





## THORACIC/CARDIOVASCULAR

Thorax-cardiovasculaire  
Thorax-cardiovasculair

Torace-cardiovascolare  
Torax-cardiovascular

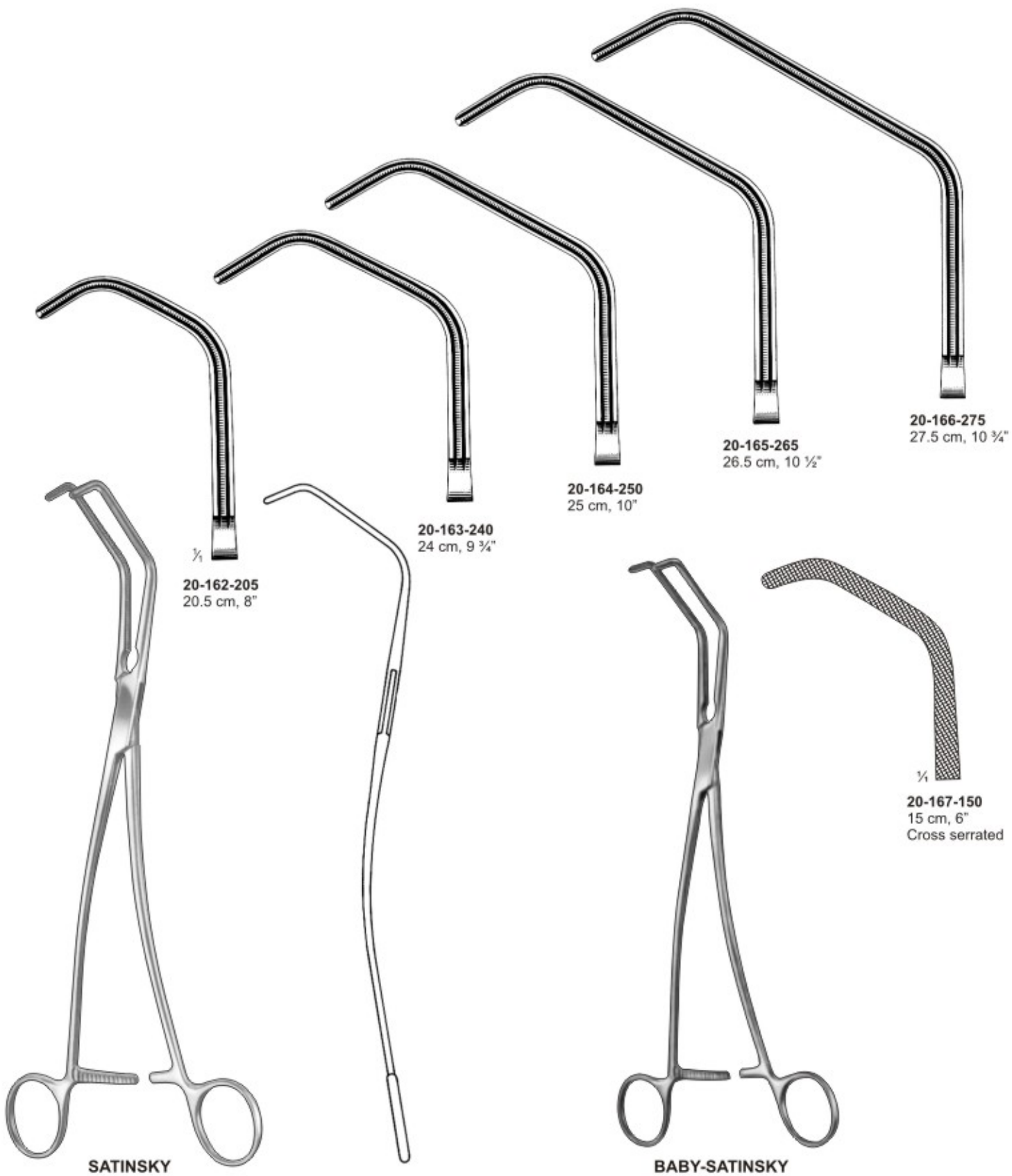

# THORACIC/CARDIOVASCULAR

Thorax-cardiovasculaire  
Thorax-cardiovasculair

Torace-cardiovascolare  
Torax-cardiovascular

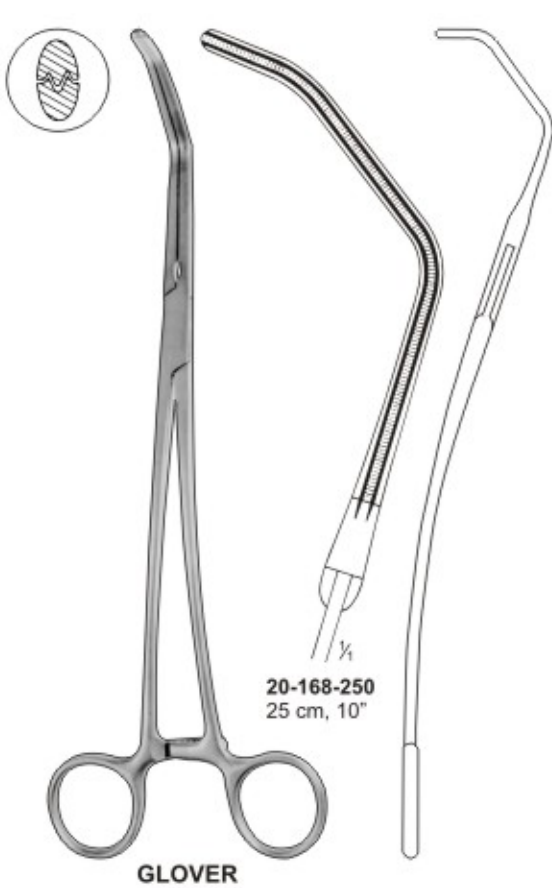

20-168-250  
25 cm, 10"

GLOVER



20-169-215  
21.5 cm, 8 1/2"

20-170-260  
26 cm, 10 1/4"

COOLEY

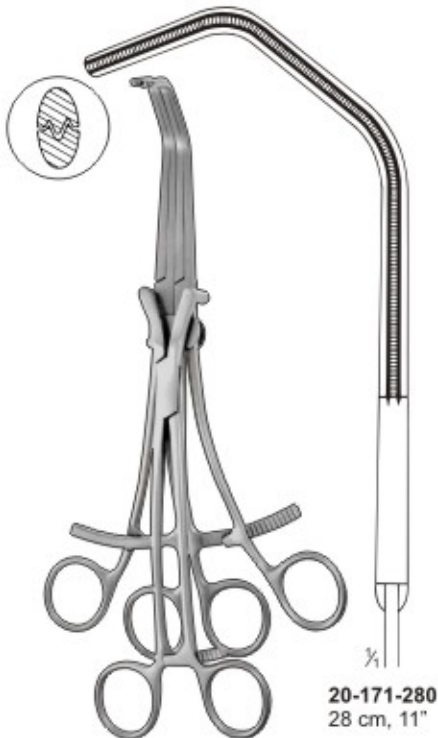

20-171-280  
28 cm, 11"

PENZSUOLI

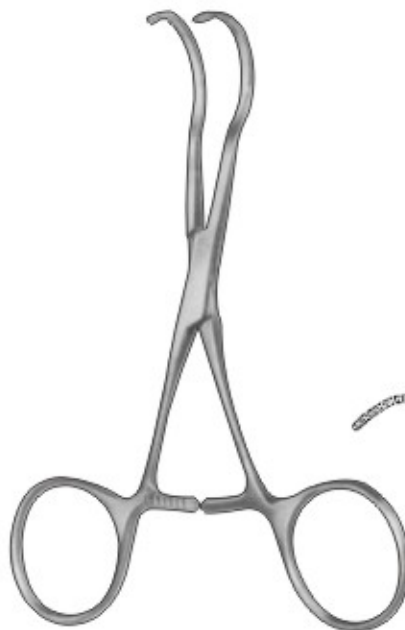

CASTANEDA

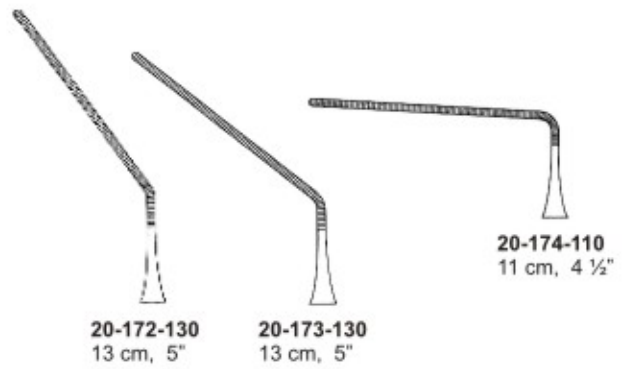

20-172-130  
13 cm, 5"

20-173-130  
13 cm, 5"

20-174-110  
11 cm, 4 1/2"



20-175-120  
12 cm, 4 3/4"

20-176-120  
12 cm, 4 3/4"

20-177-120  
12 cm, 4 3/4"

20-178-120  
12 cm, 4 3/4"





# THORACIC/CARDIOVASCULAR

Thorax-cardiovasculaire  
Thorax-cardiovasculair

Torace-cardiovascolare  
Torax-cardiovascular



**CASTAMEDA**



**CASTAMEDA**

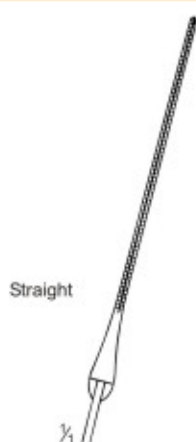

Straight

$\frac{1}{2}$

**20-179-130**  
13 cm, 5"

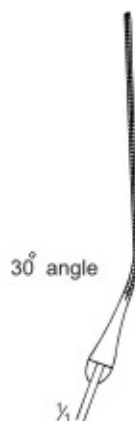

30° angle

$\frac{1}{2}$

**20-180-130**  
13 cm, 5"



50° angle

$\frac{1}{2}$

**20-181-130**  
13 cm, 5"

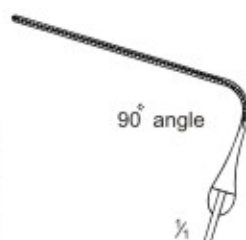

90° angle

$\frac{1}{2}$

**20-182-110**  
11 cm, 4  $\frac{1}{4}$ "

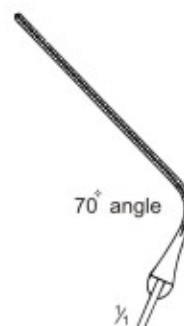

70° angle

$\frac{1}{2}$

**20-183-120**  
12 cm, 5"



$\frac{1}{2}$

**20-184-120**  
12 cm, 5"



$\frac{1}{2}$

**20-185-130**  
13 cm, 5"



# THORACIC/CARDIOVASCULAR

Thorax-cardiovasculaire  
Thorax-cardiovascular

Torace-cardiovascolare  
Torax-cardiovascular



**CASTANEDA**



**20-186-150**  
15 cm, 6"



**20-187-150**  
15 cm, 6"



**20-188-150**  
15 cm, 6"



**CASTANEDA**

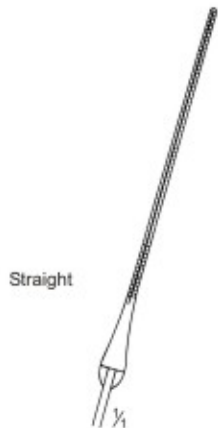

**20-189-160**  
16 cm, 6 1/4"



**20-190-160**  
16 cm, 6 1/4"



**20-191-150**  
15 cm, 6"

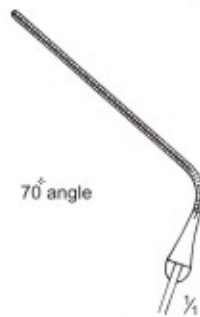

**20-192-150**  
15 cm, 6"

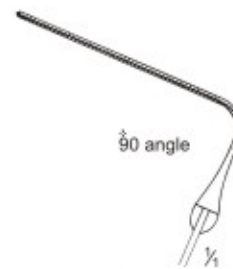

**20-193-140**  
14 cm, 5 1/2"





## THORACIC/CARDIOVASCULAR

Thorax-cardiovasculaire  
Thorax-cardiovasculair

Torace-cardiovascolare  
Torax-cardiovascular

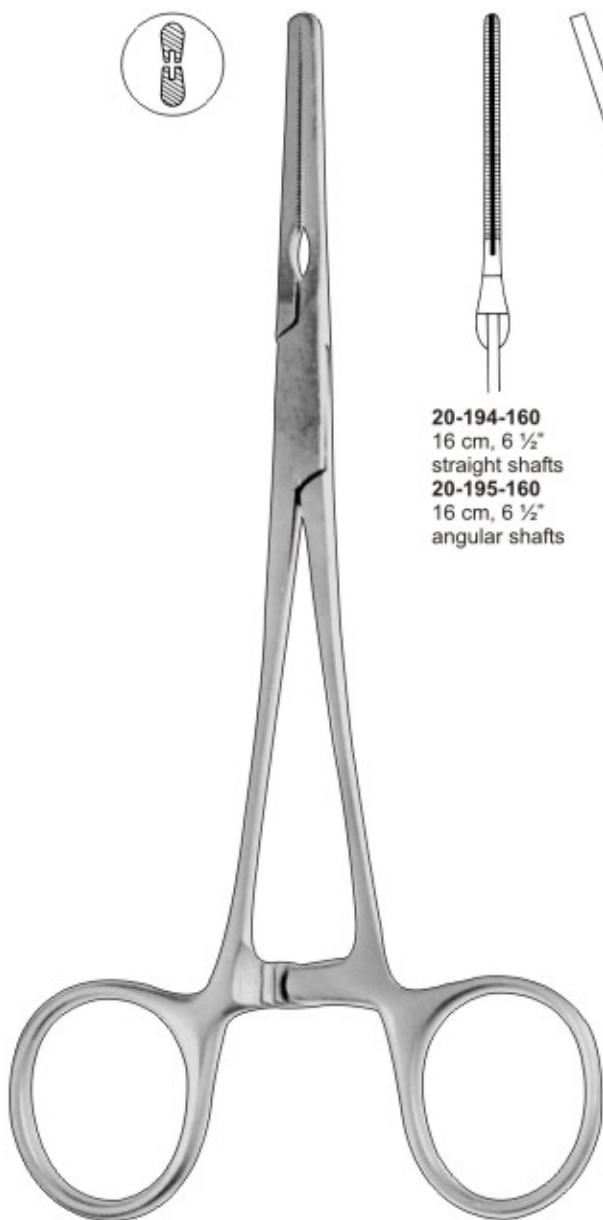

**COOLEY**  
straight jaws  
angled shanks

**20-194-160**  
16 cm, 6 1/2"  
straight shafts  
**20-195-160**  
16 cm, 6 1/2"  
angular shafts

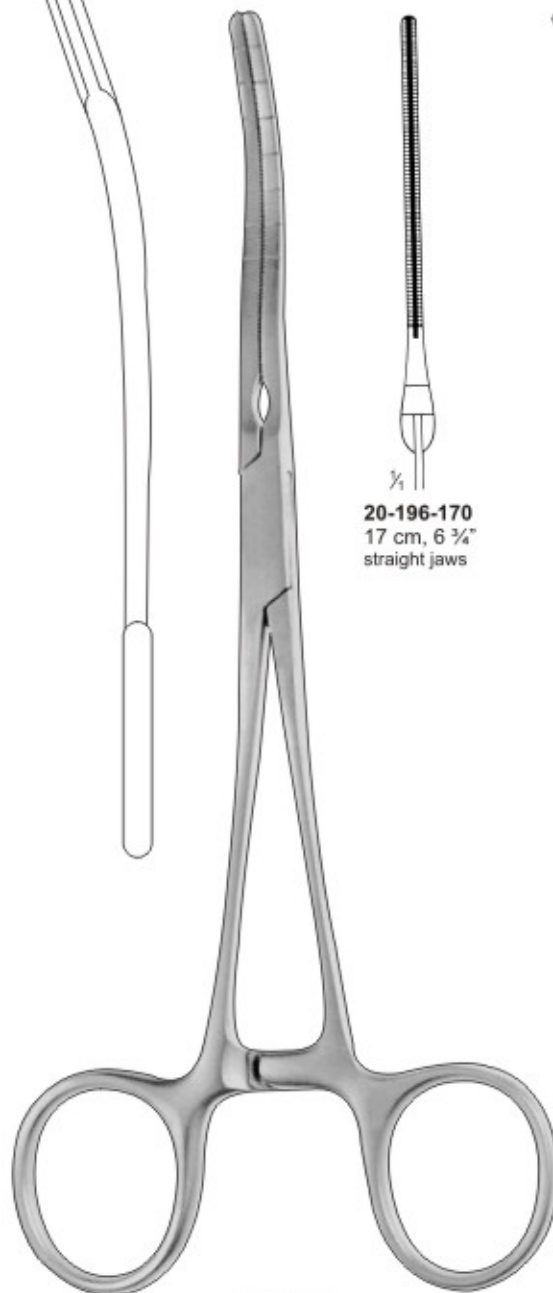
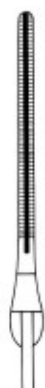

**COOLEY**

**20-196-170**  
17 cm, 6 3/4"  
straight jaws



**20-197-170**  
17 cm, 6 3/4"  
curved jaws



**20-198-170**  
17 cm, 6 3/4"  
spoon-shaped  
jaws



# THORACIC/CARDIOVASCULAR

Thorax-cardiovasculaire  
Thorax-cardiovasculair

Torace-cardiovascolare  
Torax-cardiovascular

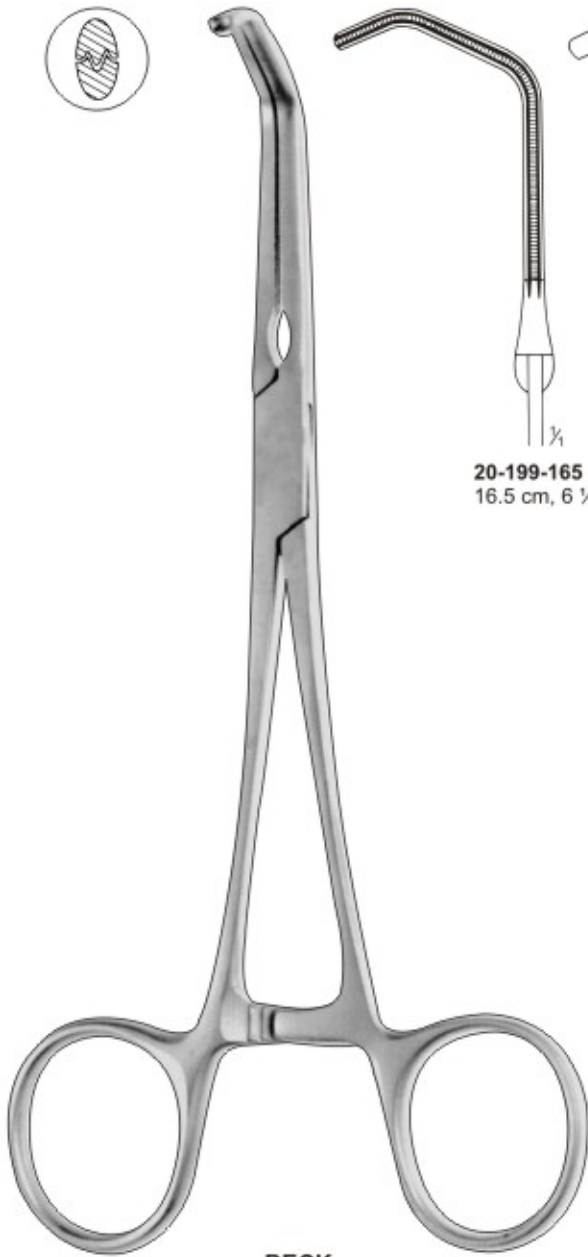

**BECK**

20-199-165  
16.5 cm, 6 1/2"

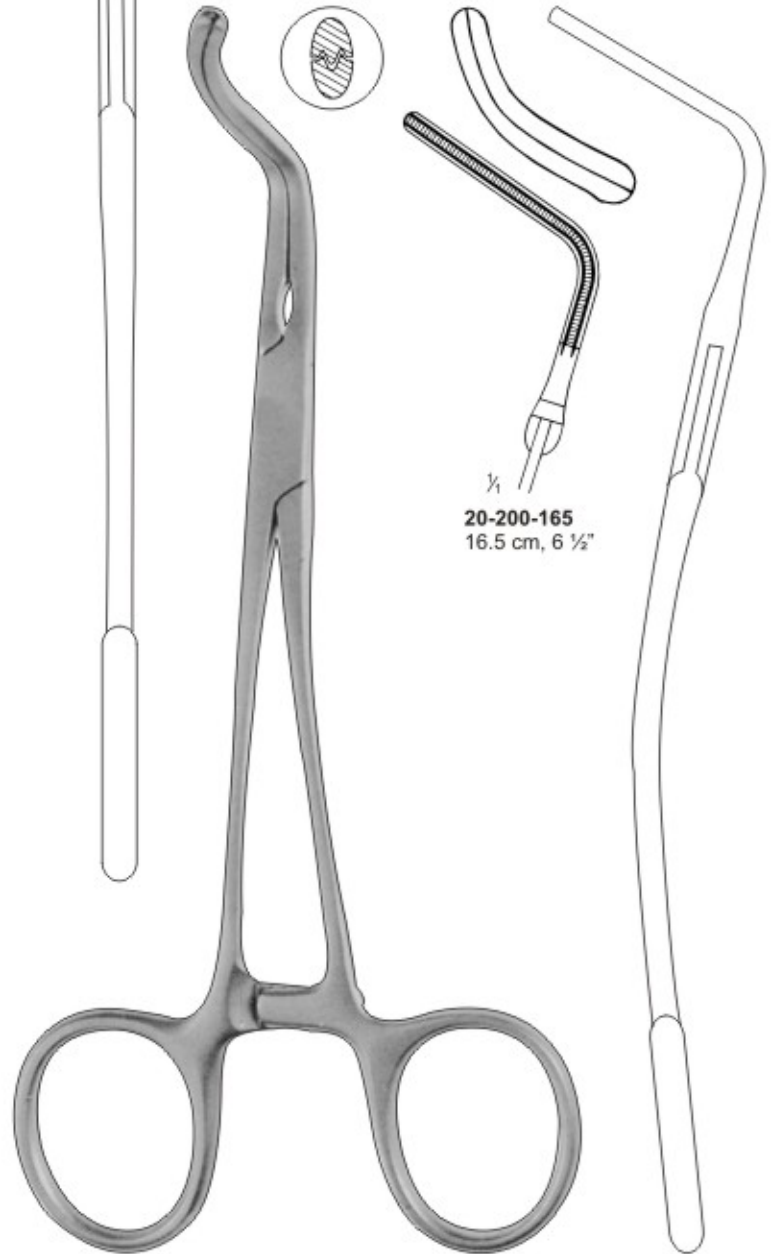
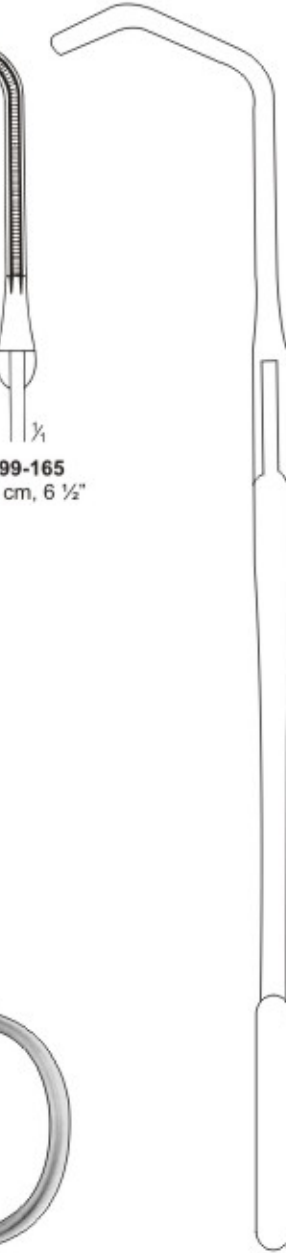

**SUBRAMANIAN**

20-200-165  
16.5 cm, 6 1/2"



## THORACIC/CARDIOVASCULAR

Thorax-cardiovasculaire  
Thorax-cardiovasculair

Torace-cardiovascolare  
Torax-cardiovascular

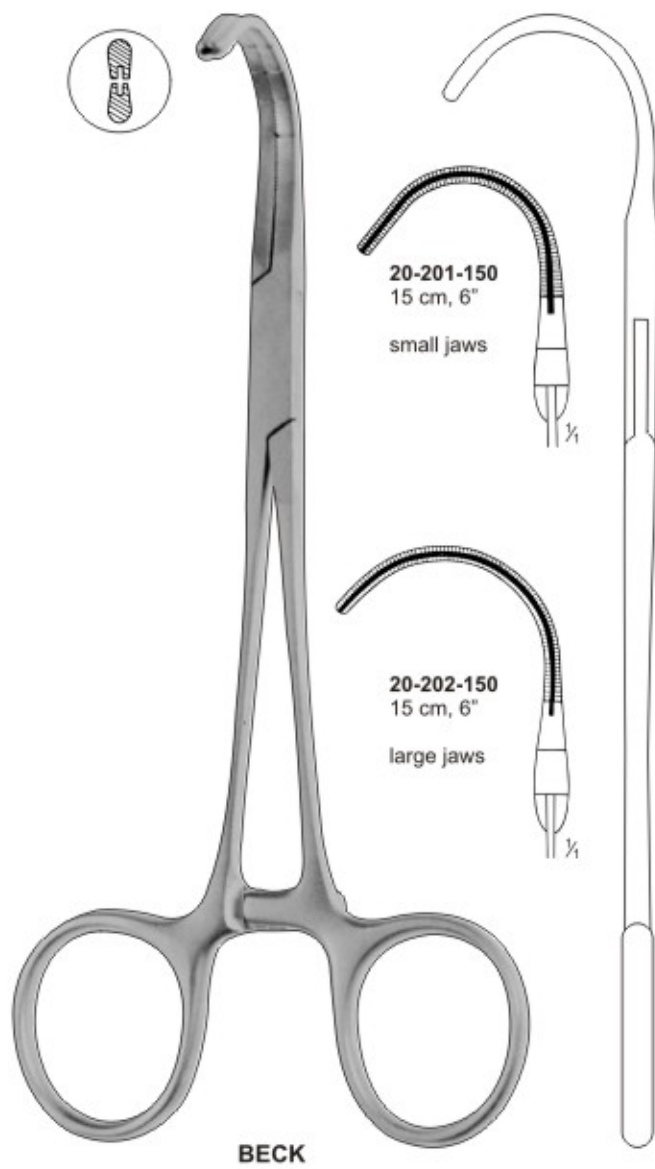

# THORACIC/CARDIOVASCULAR

Thorax-cardiovasculaire  
Thorax-cardiovasculair

Torace-cardiovascolare  
Torax-cardiovascular



COELY

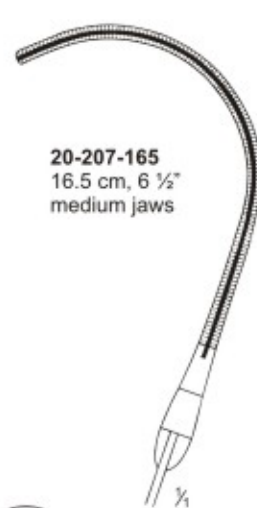
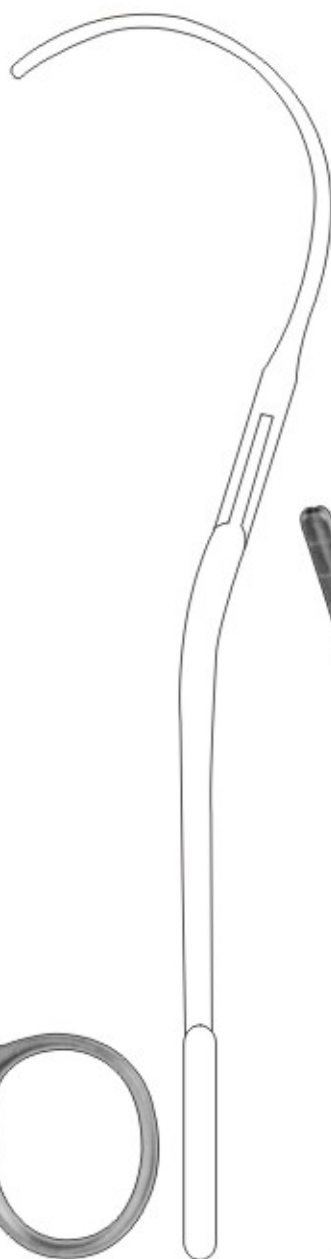

20-207-165  
16.5 cm, 6 1/2"  
medium jaws

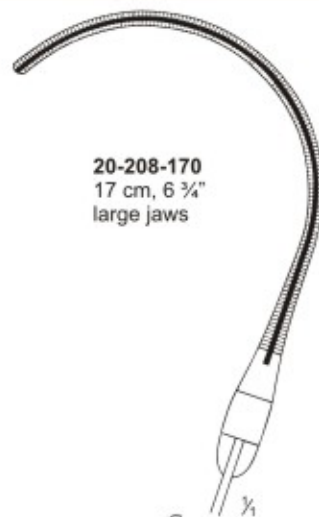

20-208-170  
17 cm, 6 3/4"  
large jaws

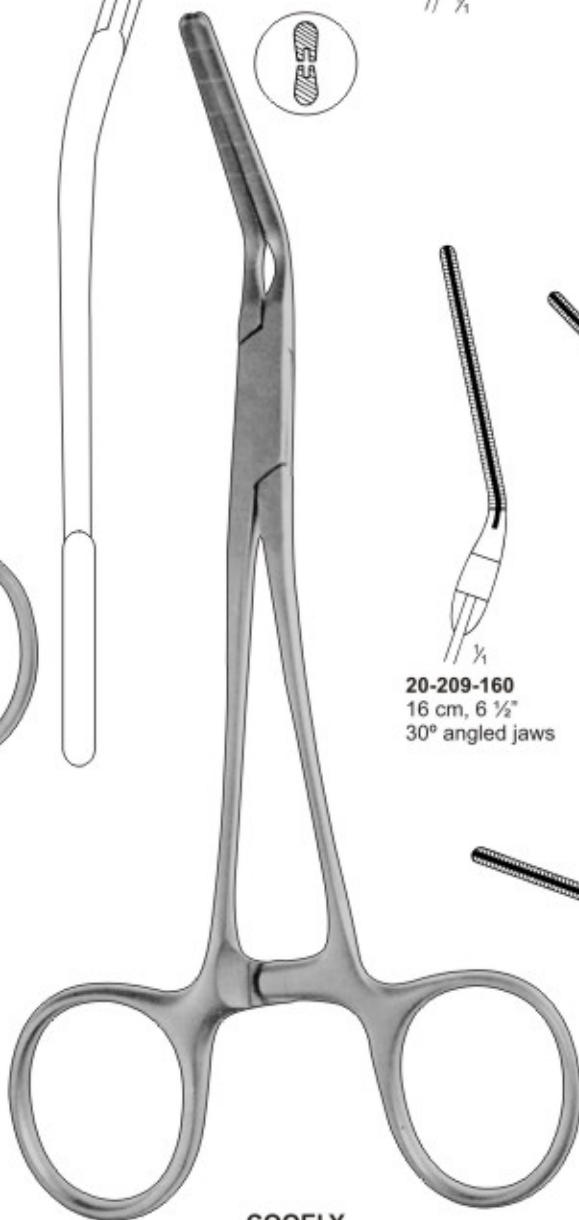

COELY



20-209-160  
16 cm, 6 1/2"  
30° angled jaws



20-210-160  
16 cm, 6 1/2"  
60° angled jaws



20-211-160  
16 cm, 6 1/2"  
90° angled jaws





## THORACIC/CARDIOVASCULAR

Thorax-cardiovasculaire  
Thorax-cardiovasculair

Torace-cardiovascolare  
Torax-cardiovascular



COOLEY-DERRA



20-212-165  
16.5 cm, 6 1/2"



20-213-170  
17 cm, 6 3/4"



20-214-180  
18 cm, 7"

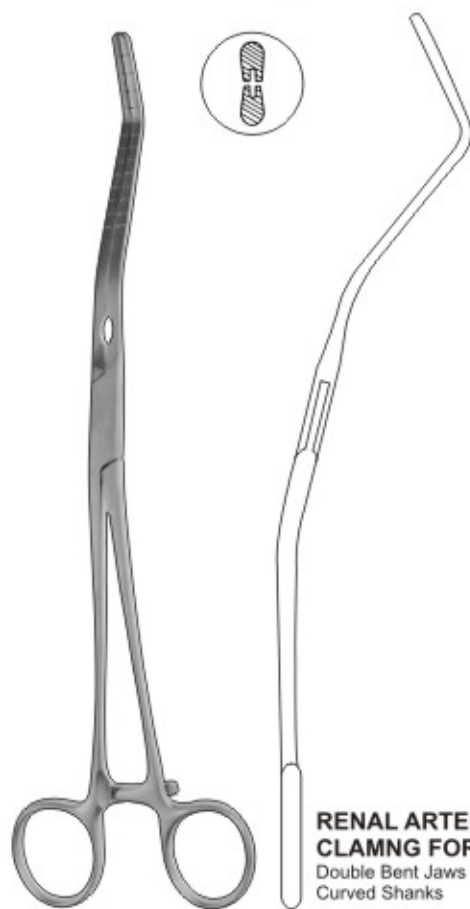

RENAL ARTERY  
CLAMNG FORCEPS  
Double Bent Jaws  
Curved Shanks



20-215-190  
19 cm, 7 1/2"

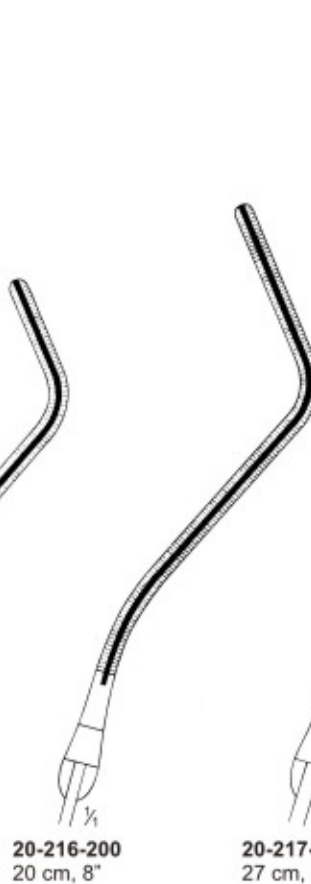

20-216-200  
20 cm, 8"

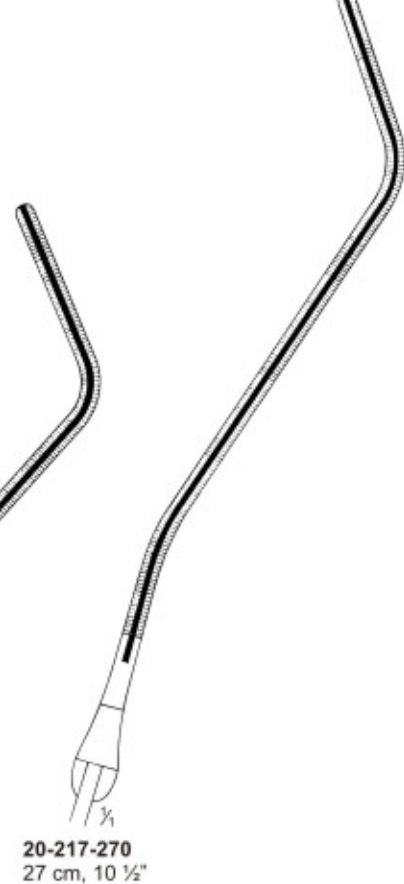

20-217-270  
27 cm, 10 1/2"

# BRONCHUS CLAMPS, CAROTIS-SHUNT CLAMPS

Bronchusklemmen, Carotis-Shuntklemmen  
Pinzas bronquiales, Pinzas para shunt carótido

Pince-clamps à bronches, Pincés pour carotide  
Pinze per bronchi, Pinze carotis



20-218-220  
jaw with ns

20-219-220  
jaw with ns



**PRICE THOMAS**  
Bronchus Clamp  
22 cm, 8 3/4"



**PRICE-THOMAS**  
22 cm, 8 3/4"



20-220-220  
22 cm, 8 3/4"



**JAVID**



20-221-180  
18 cm, 7"  
Small,  
4mm Ring



**DE BAKEY / PEDIATRIC**



20-222-120  
12 cm, 5"  
Angled, 43mm tip





## RIB CONTRACTORS

Rippenkontraktoren  
Aproximadores para costillas

Rapprocheurs des côtes  
Approssimatori costali



**BAILEY-GIBBON**  
20-223-200  
20 cm, 8"  
For Adult



20-224-200  
20 cm, 8"  
For children



**BAILEY-BABY**  
20-225-150  
15 cm, 6"



**SELLORS RIB CONTRACTOR**  
20-226-200  
20 cm, 8"



**BLALOCK**



20-227-150  
15 cm, 6"

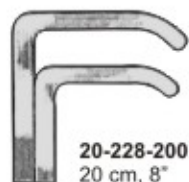

20-228-200  
20 cm, 8"

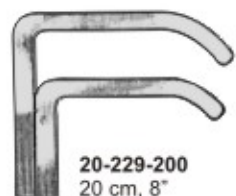

20-229-200  
20 cm, 8"

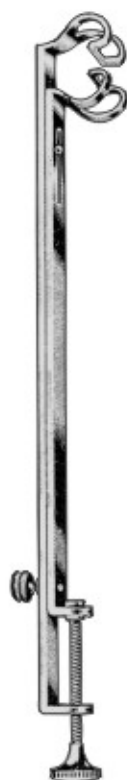

**JOHNS-HOPKINS  
(POTTS Modif.)**



20-230-200  
20 cm, 8"



20-231-200  
20 cm, 8"



20-232-200  
20 cm, 8"

# LUNG SPATULAS, AORTIC DILATORS



Lungenspatel, Aorta-Dilatatoren  
Espátulas pulmonares, Dilatadores aórticos

Spatules pulmonaires, Dilatateurs pour aorte  
Spatole per pulmone, Dilatatori per aorta



**ALLISON**  
20-233-250  
25 cm, 10"

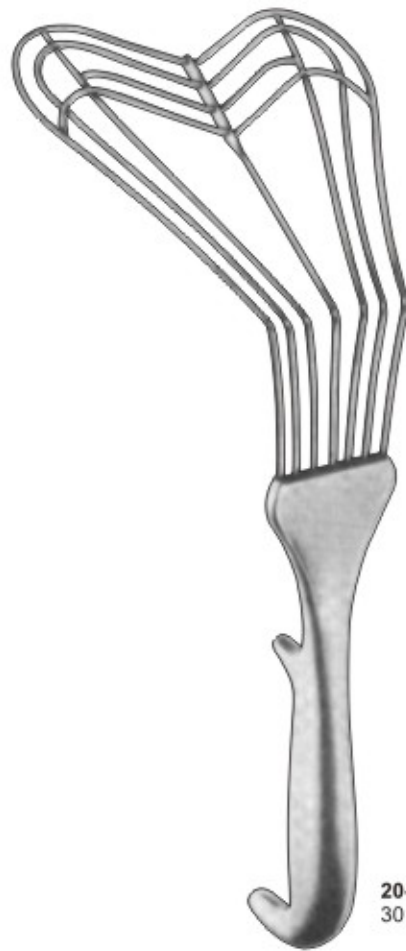

**20-234-300**  
30 cm, 12"

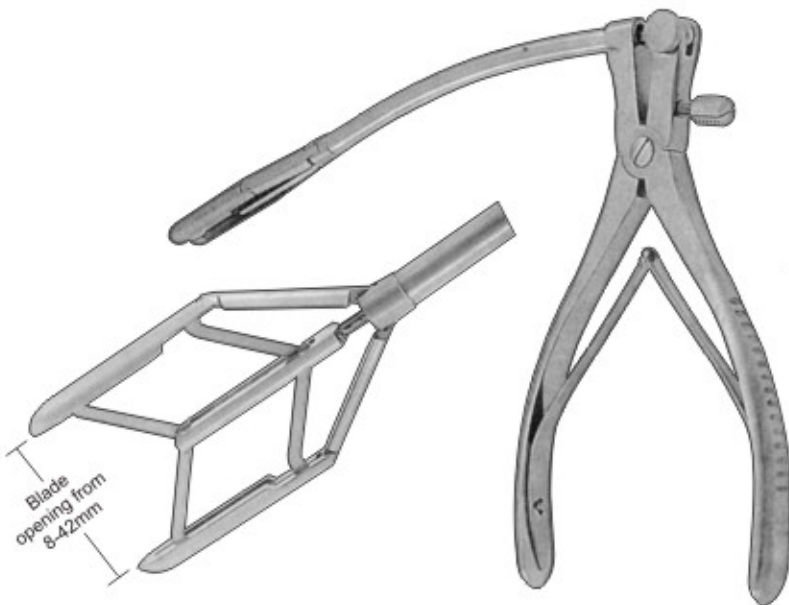

Blade  
opening from  
8-42mm

**TUBBS**  
20-235-001  
Blade Opening  
From 8 To 42 mm

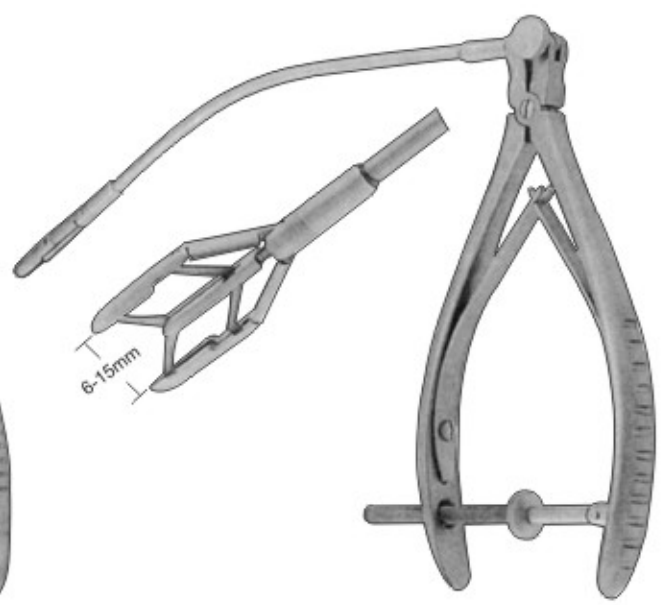

6-15mm

**COOLEY**  
20-236-002  
Blade Opening  
From 8 To 15 mm



## RIB RETRACTORS

Rippensperrer  
Separador costal

Ecarteur de côtes  
Divaricatore costale



**COOLEY**  
**20-237-001**  
latral blades 12 x 16 mm spreading 95 mm



**COOLEY**  
**20-238-001** latral blades 15 x 30 mm, spreading 140 mm  
**20-239-002** latral blades 21 x 44 mm, spreading 150 mm



**COOLEY**  
**20-240-001**  
latral blades 35 x 50 mm, spreading 200 mm

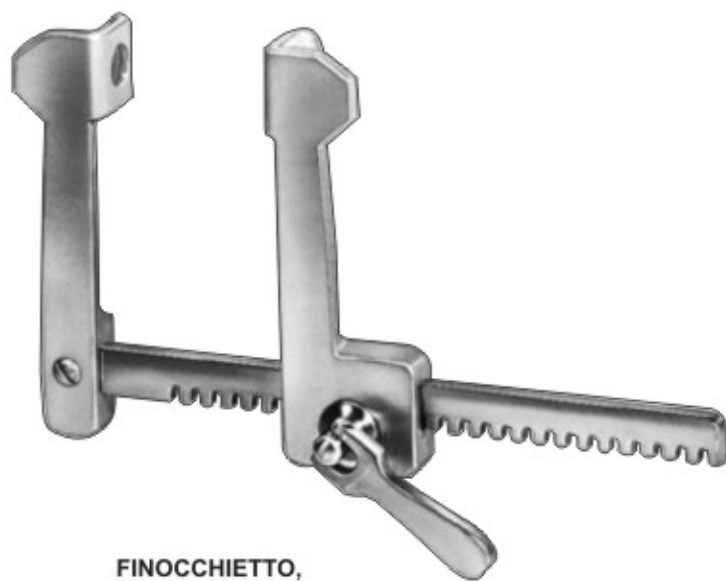

**FINOCCHIETTO,**  
**20-241-001**  
latral blades 15 x 15 mm, spreading 75 mm, infant  
latral blades 31 x 31 spreading 100 mm, baby - height  
latral blades 40 x 45 spreading 135 mm, baby - height  
latral blades 52 x 62 spreading 175 mm, baby - height  
latral blades 84 x 65 spreading 175 mm, baby - height

## RIB RETRACTORS

Rippensperrer  
Separador costal

Ecarteur de côtes  
Divaricatore costale



**HAIGHT RIB RETRACTOR**  
20-242-001  
lateral blades 30 x 30 mm, spreading 120 mm

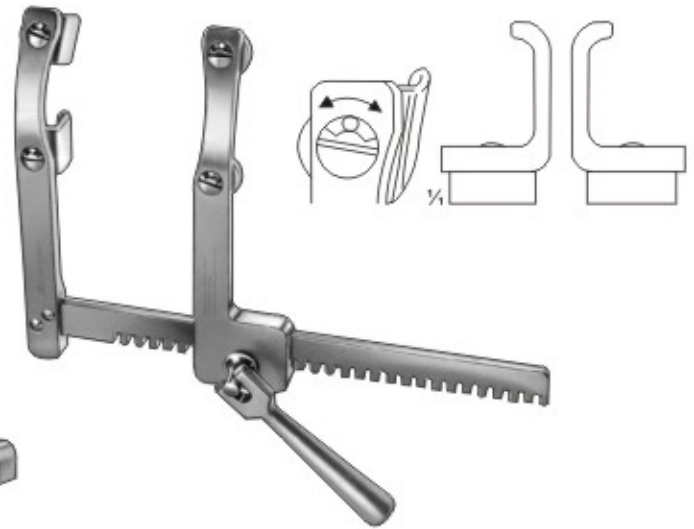

**MORSE-FAVALORO STERNAL RETRACTOR**  
20-243-001  
4 movable blades 17 x 22 mm, spreading 160mm for children



**FINOCCHIETTO (MODIF.)**  
20-244-001  
lateral blades 14 x 15 mm, spreading 120 mm



**TUFFIER RIB RETRACTOR**  
20-245-001  
lateral blades 45 x 45 mm, spreading 160 mm



## RIB RETRACTORS

Rippensperrer  
Separador costal

Ecarteur de côtes  
Divaricatore costale

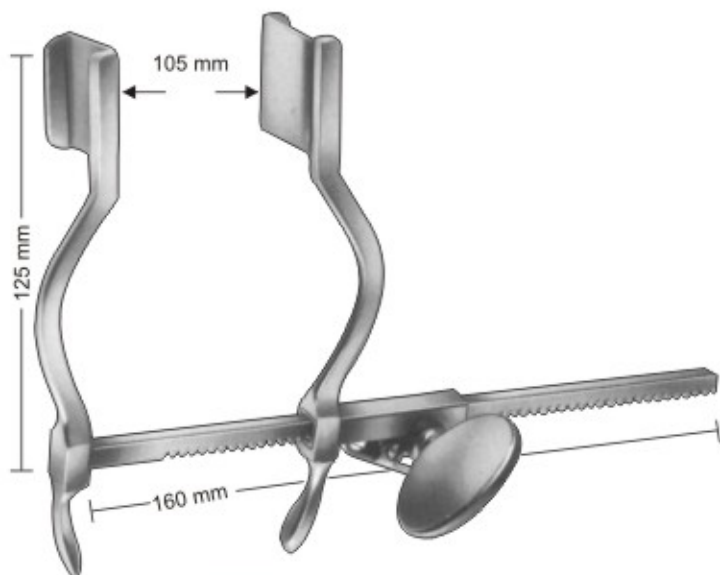

**HERTZLER**  
20-246-001  
blades 20 x 25 mm, spreading 105 mm

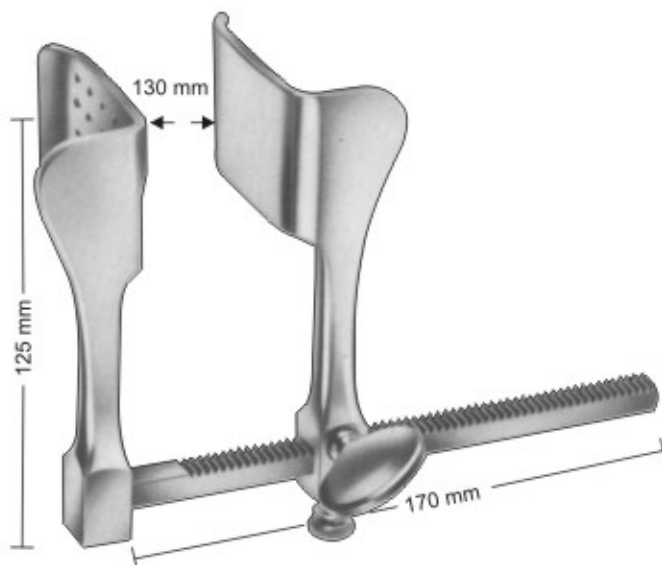

**TUFFIER**  
20-247-001  
blades 43 x 53 mm, spreading 130 mm



### THORACIC RETRACTOR

- 20-248-001 Retractor only
- 20-249-002 pair of blades, 48 x 68 mm
- 20-250-003 1 pair of blades, 70 x 75 mm

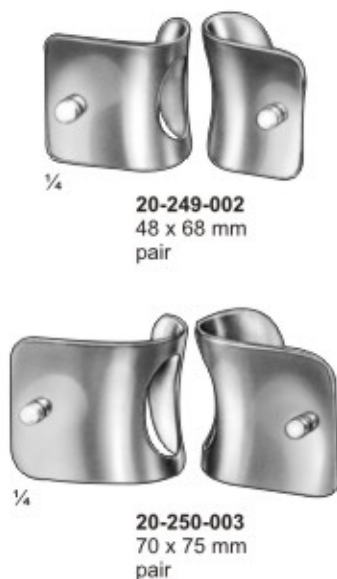

### THORACIC & I.M.A

- 20-251-001 Complete set
- 20-252-002 lateral blades for I.M.A Retractor  
left 40 x 50 x 80 mm
- 20-253-003 lateral blades for I.M.A Retractor  
Right 40 x 50 x 80 mm

# RIB RETRACTORS



Rippensperrer  
Separador costal

Ecarteur de côtes  
Divaricatore costale

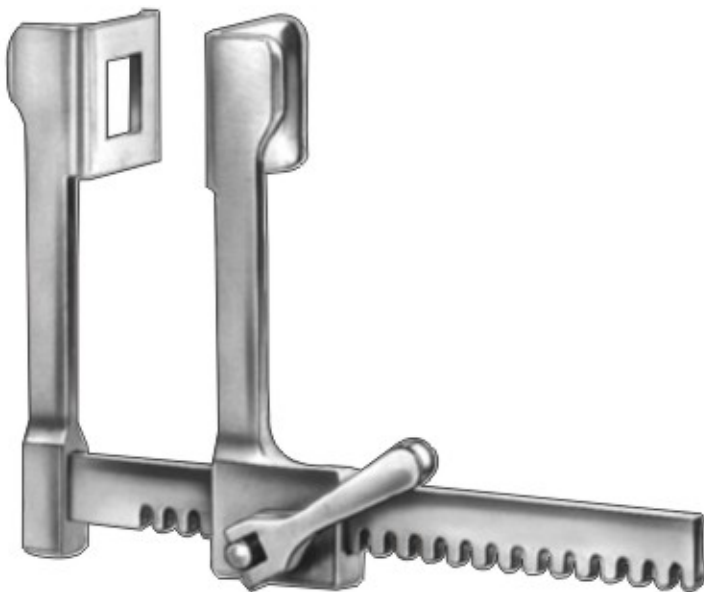

**FINOCCHIETTO/BABY**  
20-254-075  
7.5 cm, 3"  
14 mm x 15 mm spreading 75 mm



**FINOCCHIETTO,**  
20-255-200  
20 cm, 8"  
20-256-001 30 mm x 45 mm spreading 150 mm  
20-257-002 46 mm x 62 mm spreading 190 mm  
20-258-003 80 mm x 65 mm spreading 190 mm

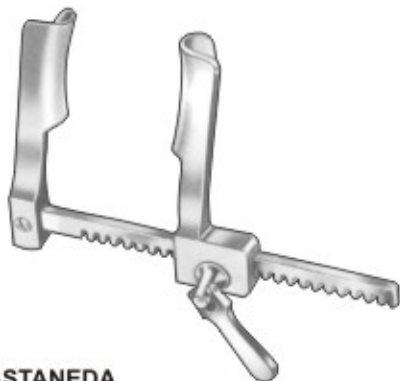

**CASTANEDA**  
20-259-200 10.5 mm x 32 mm spreading 65 mm



**CASTANEDA**  
20-260-200 12 mm x 45 mm spreading 70 mm



**CASTANEDA**  
20-261-200 15 mm x 60 mm spreading 120 mm



## RIB RETRACTORS

Rippensperrer  
Separador costal

Ecarteur de côtes  
Divaricatore costale



**BURFORD**  
**20-262-180**  
18 cm, 7, For children  
spread with 2 sets of Blades

**20-263-180** 48 mm x 42 mm spreading 135 mm  
**20-264-180** 38 mm x 42 mm spreading 135 mm



**BURFORD**  
**20-265-180**  
18 cm, 7, For Adults  
spread with 2 sets of Blades

**20-266-001** With two pair of blade 47 x 62 mm + 65 x 62 mm spreading 200 mm

**20-267-002** with 2 pair of blade 47 x 62 mm + 65 x 62 mm spreading 260 mm

**20-268-003** with 2 pair of blade 47 x 62 mm + 65 x 62 mm spreading 300 mm

## RIB SHEARS, STERNUM CHISEL

Rippenscheren, Sternummeißel  
Costotomos, Cinceles

Costotomes, ciseau-Burin à sternum  
Costotomi, Scalpello per sterno



**SAUERBRUCH-FREY**  
20-269-370  
for the first rib  
37 cm, 14 ½"



**SCHUMACHER**  
20-270-210  
sternum shears  
21 cm, 8 ¼"



**BONE SHEAR**  
20-271-230  
23 cm, 9"



**RIB SHEAR**  
20-272-230  
23 cm, 9"



**GLUCK  
RIB SHEAR**  
20-273-220  
22 cm, 8 ¾"



**LEBSCHE  
STERNUM CHISEL**  
20-274-245  
24.5 cm, 9 ¾"





## RIB SHEARS, STERNUM CHISEL

Rippenscheren, Sternummeißel  
Costotomos, Cinceles

Costotomes, ciseau-Burin à sternum  
Costotomi, Scalpello per sterno



**SEMB**  
20-275-200  
20 cm, 8"



**SEMB**  
20-276-200  
20 cm, 8"



**GIERTZ-STILLE**  
20-277-270  
27 cm, 10 1/2"

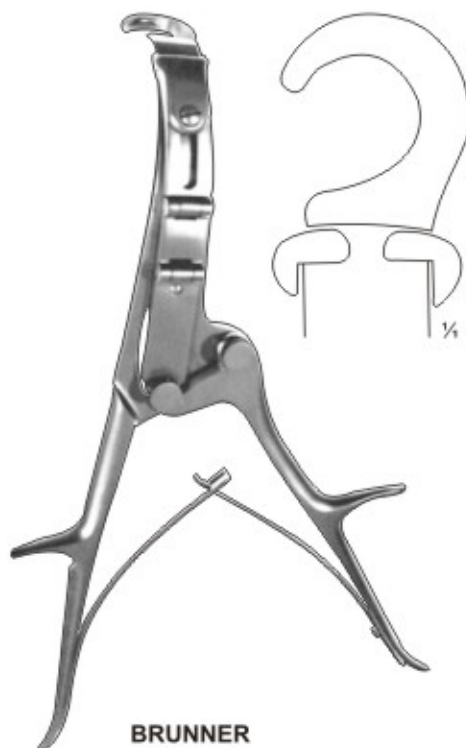

**BRUNNER**  
20-278-335  
33.5 cm, 13"



**MAURER-COLLIN**

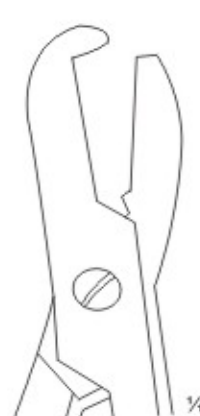

**20-279-230**  
Hooked Left  
23 cm, 9"



**20-280-230**  
Hooked Right  
23 cm, 9"

## RIB SHEARS, STERNUM CHISEL

Rippenscheren, Sternummeißel  
Costotomos, Cinceles

Costotomes, ciseau-Burin à sternum  
Costotomi, Scalpello per sterno



**SAUERBRUCH**  
20-281-240 24 cm, 9 1/2" For Children,  
20-282-270 27 cm, 10 3/4" For Adults,



**SCHUARDT**  
20-283-170  
17 cm, 6 3/4"



**COLLIN**  
20-284-190  
19 cm, 7 1/4"



**DOYEN**  
20-285-190  
19 cm, 7 1/4"



# THORACIC/CARDIOVASCULAR

Thorax-cardiovasculaire  
Thorax-cardiovasculair

Torace-cardiovascolare  
Torax-cardiovascular



20-287-002  
Plastic Probe tip



20-288-003  
3 mm Ø  
Olive



20-289-004  
6 mm Ø  
Olive



20-290-005  
9 mm Ø  
Olive



20-291-006  
12 mm Ø  
Olive

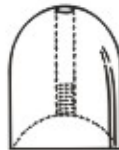

20-292-007  
15 mm Ø  
Olive

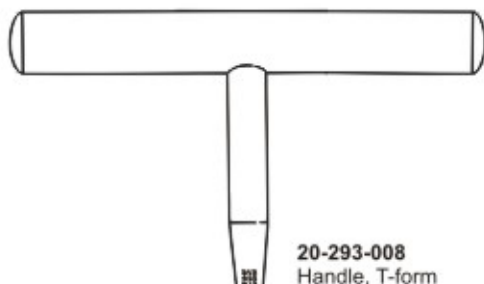

20-293-008  
Handle, T-form



TRACTION CABLE  
20-294-900  
90 cm, 36"

# INTESTINAL AND RECTAL INSTRUMENTS

---

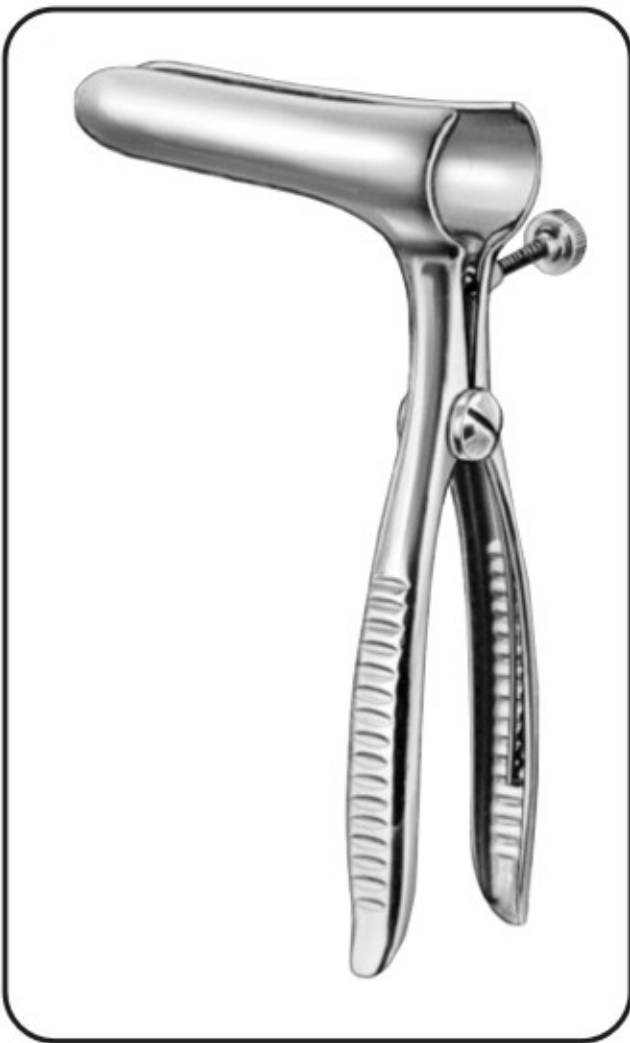



## INTESTINAL & TISSUE GRASPING FORCEPS

Darm-und Gewebefassungen  
Pinzas Para Intestinos y Tejidos

Pinces Pour Saisir Intestins et Tissus  
Pinze Per Afferrare Intestino e Tessuti

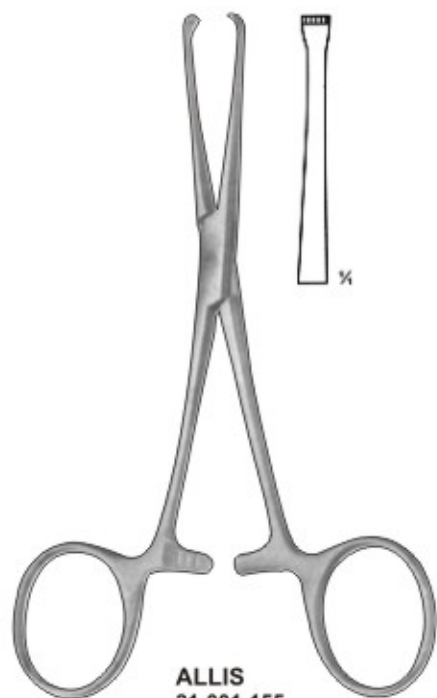

**ALLIS**  
21-001-155  
3 x 4 teeth  
15.5 cm, 6"

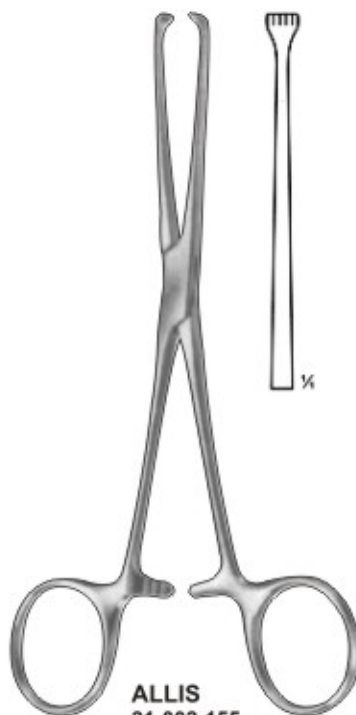

**ALLIS**  
21-002-155  
4 x 5 teeth  
15.5 cm, 6"

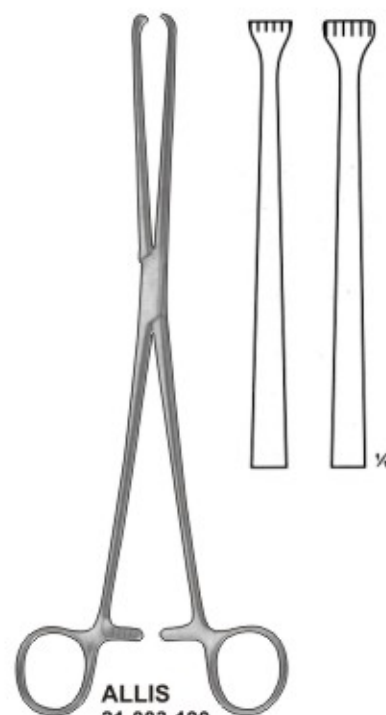

**ALLIS**  
21-003-190  
19.0 cm, 7 1/2"  
21-004-255  
25.5 cm, 10"  
5 x 6 teeth

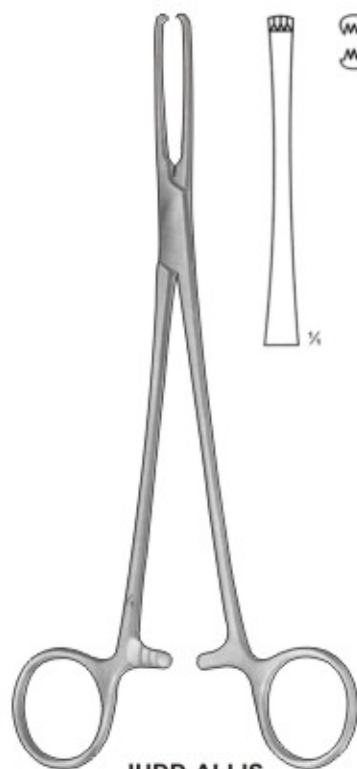

**JUDD-ALLIS**  
21-005-195  
3 x 4 teeth  
19.5 cm, 7 3/4"

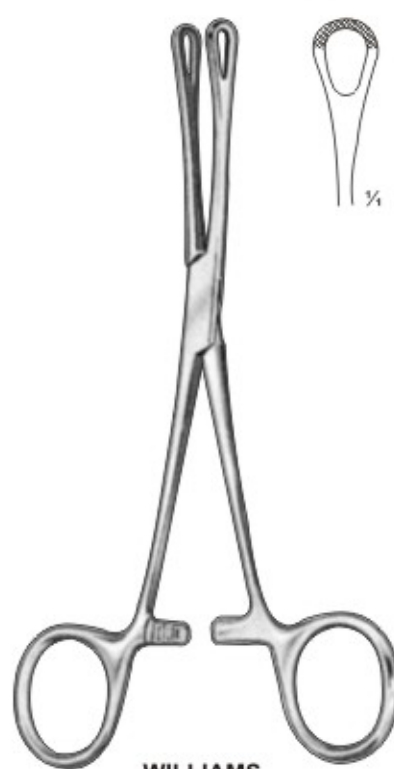

**WILLIAMS**  
21-006-160  
16 cm, 6 1/4"

# INTESTINAL & TISSUE GRASPING FORCEPS

Darm-und Gewebefasszangen  
Pinzas Para Intestinos y Tejidos

Pinces Pour Saisir Intestins et Tissus  
Pinze Per Afferrare Intestino e Tessuti

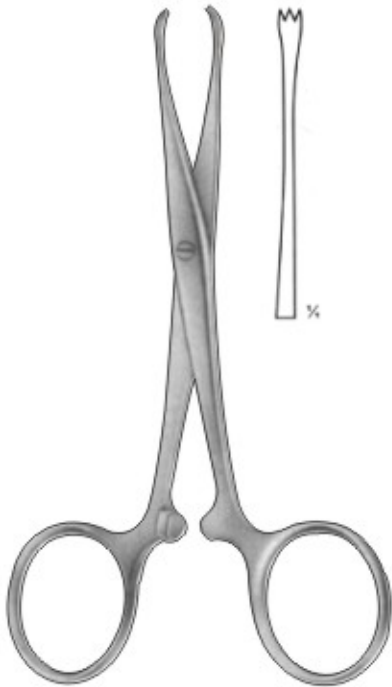

**CHAPUT**  
21-007-125  
2 x 3 teeth, sharp  
12.5 cm, 5"

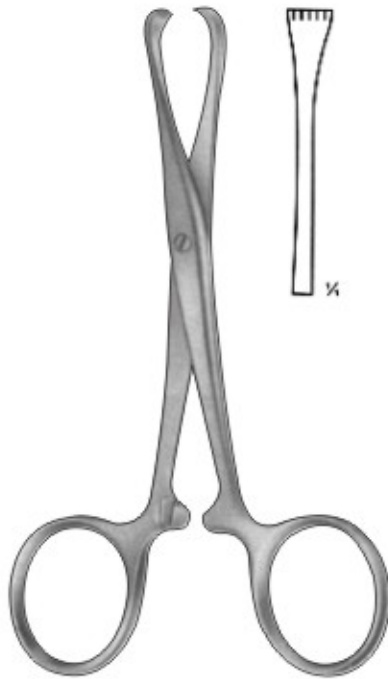

**TUFFIER**  
21-008-125  
5 x 6 teeth, sharp  
12.5 cm, 5"

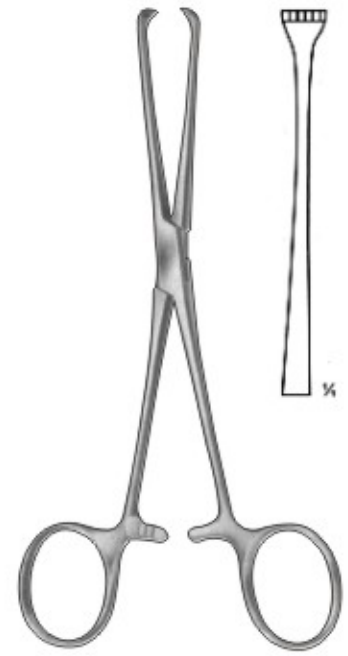

**BOYS-ALLIS**  
21-009-155  
5 x 6 teeth, sharp  
15.5 cm, 6"

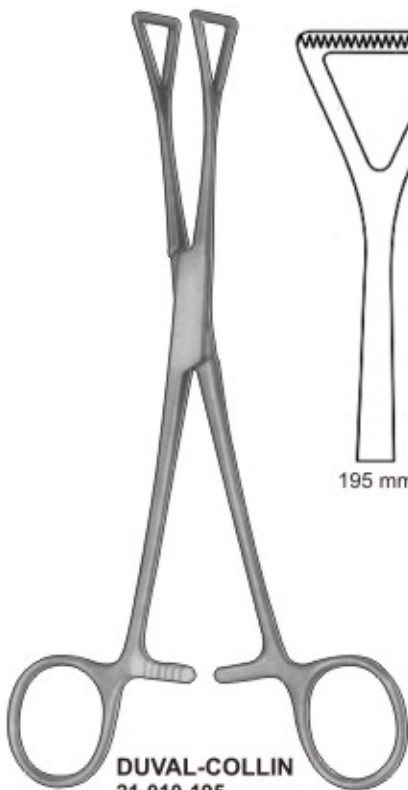

**DUVAL-COLLIN**  
21-010-195  
19.5 cm, 7 3/4"  
21-011-200  
20.0 cm, 8"

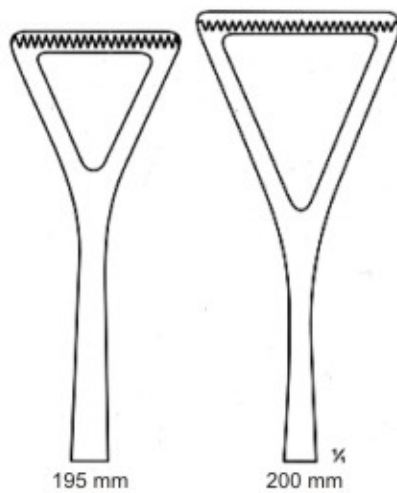

195 mm

200 mm

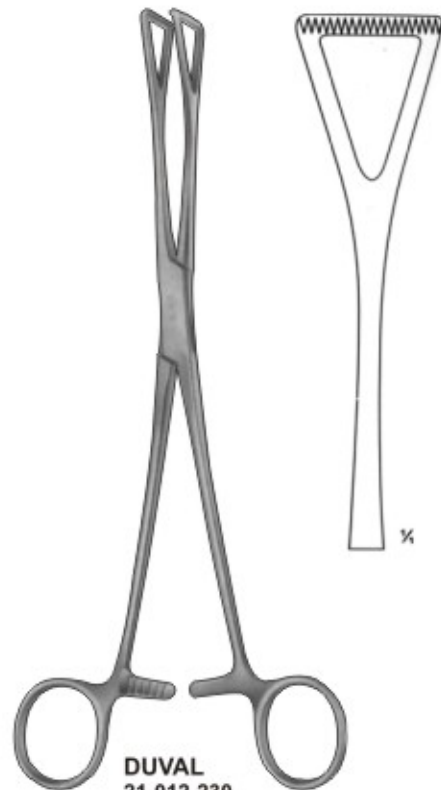

**DUVAL**  
21-012-230  
23.0 cm, 9"



## INTESTINAL & TISSUE GRASPING FORCEPS

Darm-und Gewebefasszangen  
Pinzas Para Intestinos y Tejidos

Pinces Pour Saisir Intestins et Tissus  
Pinze Per Afferrare Intestino e Tessuti

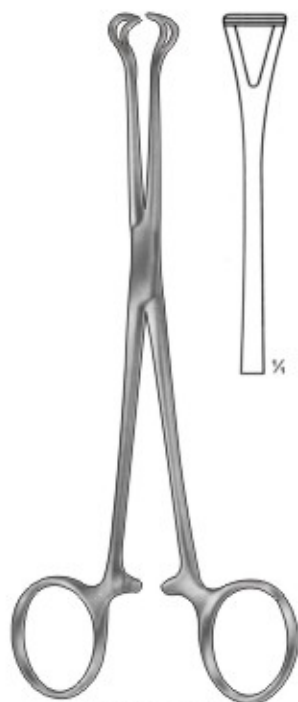

**BABCOCK**  
21-013-155  
15.5 cm, 6"

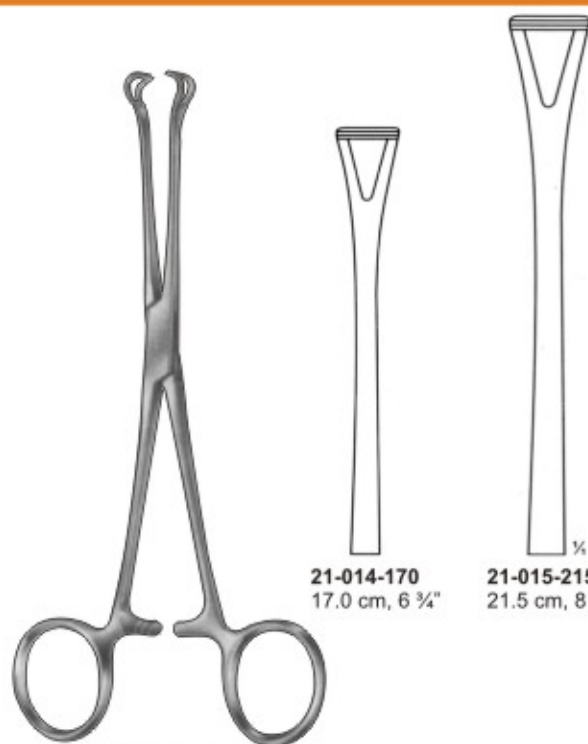

**21-014-170**  
17.0 cm, 6 3/4"

**21-015-215**  
21.5 cm, 8 1/2"

**BABCOCK**

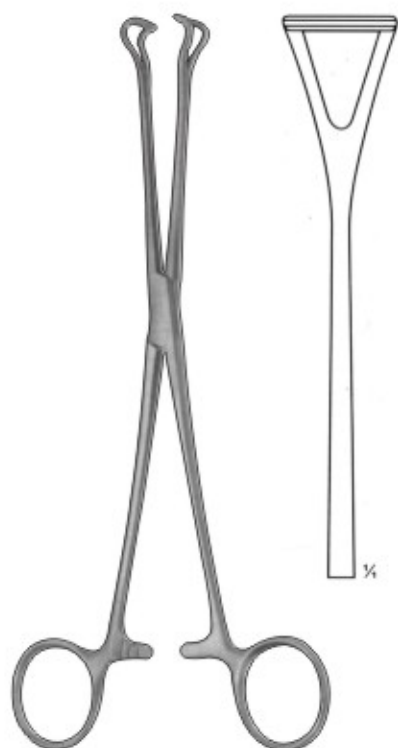

**BABCOCK**  
21-016-220  
22.0 cm, 8 3/4"

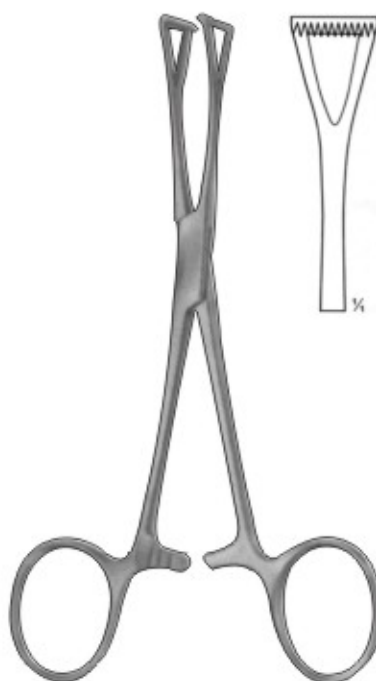

**COLLIN**  
21-017-140  
14.0 cm, 5 1/2"

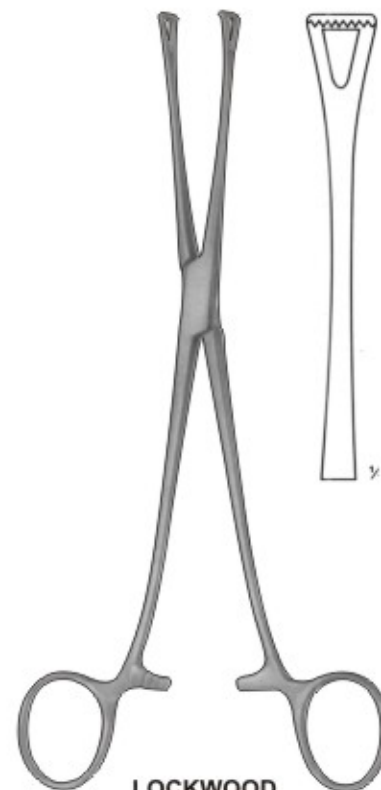

**LOCKWOOD**  
21-018-200  
20.0 cm, 8"

# INTESTINAL & TISSUE GRASPING FORCEPS

Darm-und Gewebefasszangen  
Pinzas Para Intestinos y Tejidos

Pinces Pour Saisir Intestins et Tissus  
Pinze Per Afferrare Intestino e Tessuti



**21-019-155**  
15.5 cm, 6"

**21-020-200**  
20.0 cm, 8"

**21-021-220**  
22.0 cm, 8 1/4"

**21-022-255**  
25.5 cm, 10"

**21-023-300**  
30.0 cm, 12"

**ALLIS**

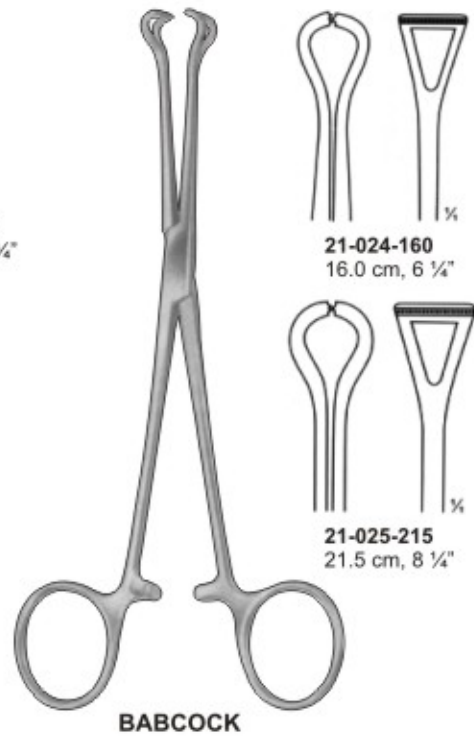

**21-024-160**  
16.0 cm, 6 1/4"

**21-025-215**  
21.5 cm, 8 1/4"

**BABCOCK**

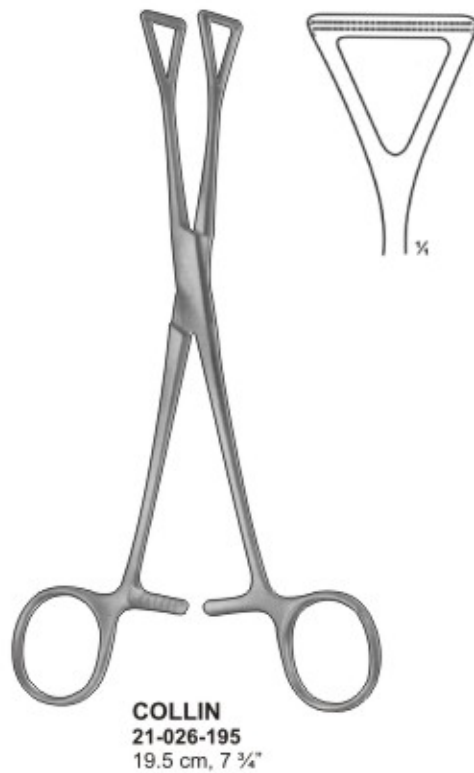

**COLLIN**  
**21-026-195**  
19.5 cm, 7 3/4"

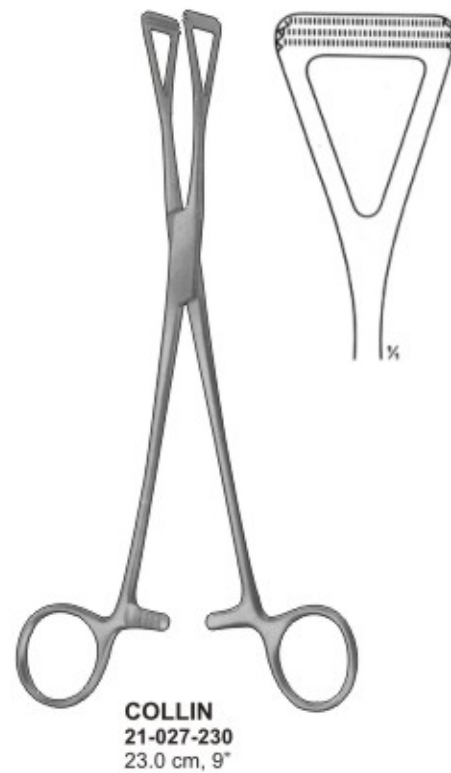

**COLLIN**  
**21-027-230**  
23.0 cm, 9"





## INTESTINAL & TISSUE GRASPING FORCEPS

Darm-und Gewebefasszangen  
Pinzas Para Intestinos y Tejidos

Pinces Pour Saisir Intestins et Tissus  
Pinze Per Afferrare Intestino e Tessuti



### BABCOCK

21-028-160 16 cm, 6 ¼"  
21-029-180 18 cm, 7"  
21-030-240 24 cm, 9 ½"



### LANE

21-031-127 12.7 cm, 5"  
21-032-150 15 cm, 6"  
21-033-190 19 cm, 7 ½"



### LITTLE WOOD TISSUE FORCEPS

21-034-190  
19 cm, 7 ½" Box Joint

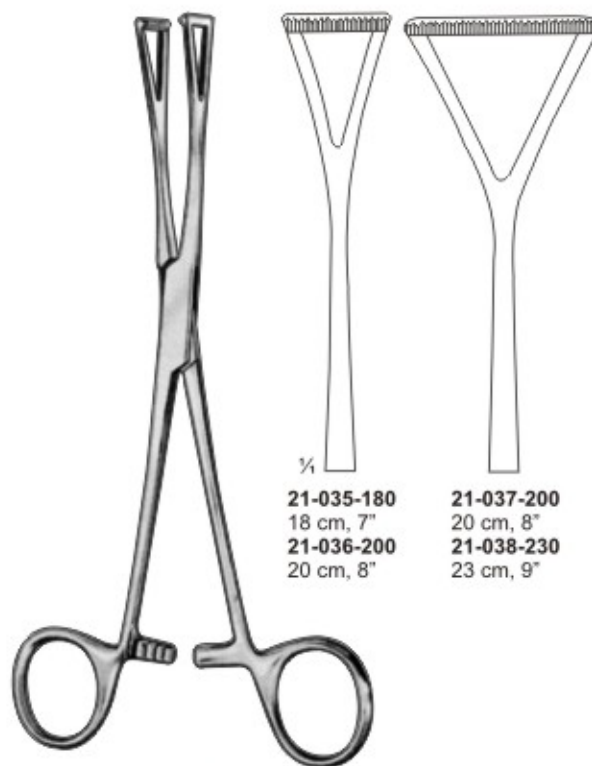

### DUVAL

21-035-180  
18 cm, 7"  
21-036-200  
20 cm, 8"

21-037-200  
20 cm, 8"  
21-038-230  
23 cm, 9"

# INTESTINAL CLAMPS



Darmklemmen  
Pinzas Intestinales

Pinces Intestinales  
Pinze Intestinali

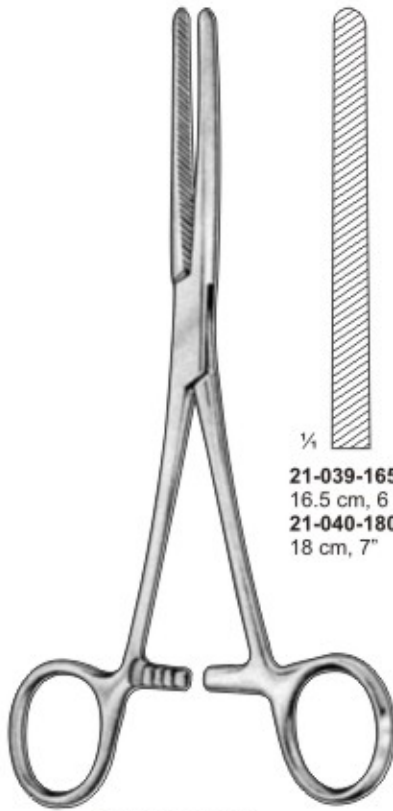

¼  
21-039-165  
16.5 cm, 6 ½"  
21-040-180  
18 cm, 7"

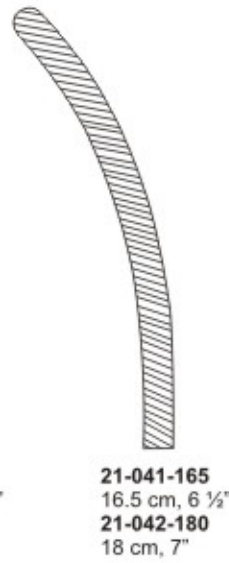

21-041-165  
16.5 cm, 6 ½"  
21-042-180  
18 cm, 7"



¼  
21-043-210  
21 cm, 8 ¼"  
21-044-230  
23 cm, 9"  
21-045-250  
25 cm, 10"



21-046-210  
21 cm, 8 ¼"  
21-047-230  
23 cm, 9"  
21-048-250  
25 cm, 10"

BABY-DOYEN

MAYO-ROBSON

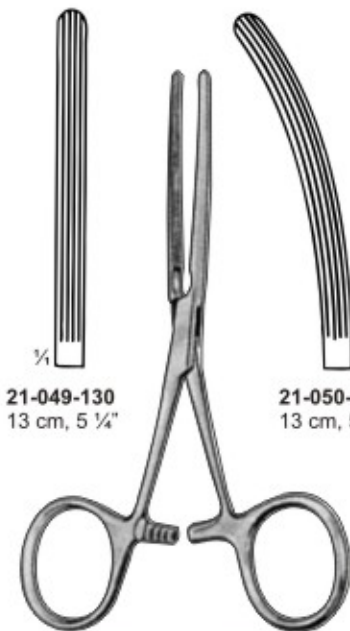

¼  
21-049-130  
13 cm, 5 ¼"

21-050-130  
13 cm, 5 ¼"



¼  
21-051-220  
22 cm, 8 ¾"  
Straight



¼  
21-052-210  
21 cm, 8 ¼"  
21-053-230  
23 cm, 9"  
straight,  
grooved

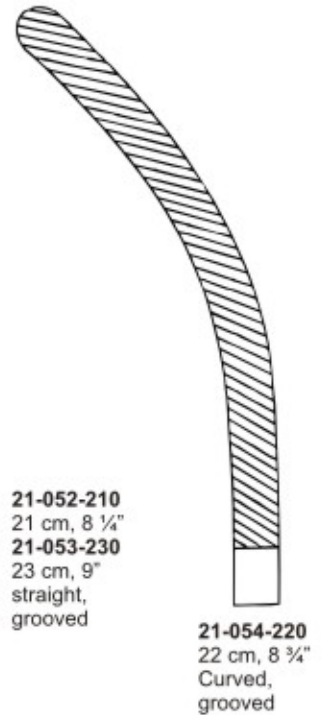

21-054-220  
22 cm, 8 ¾"  
Curved,  
grooved

BABY-KOCHER

KOCHER

DOYEN



## POLYOUS GRASPING FORCEPS, ANASTOMOSIS

Polypenfasszange, Darm-anastomosenklemmen

Pinza Para Coger Pólipos, Clamps Para Anastomosis Intestinales

Pince Pour Saisir Polypes, Pincés-clamps Pour Anastomose Intestinale

Pinze Per Afferrare Polipi, Pinze Per Anastomosi Intestinali

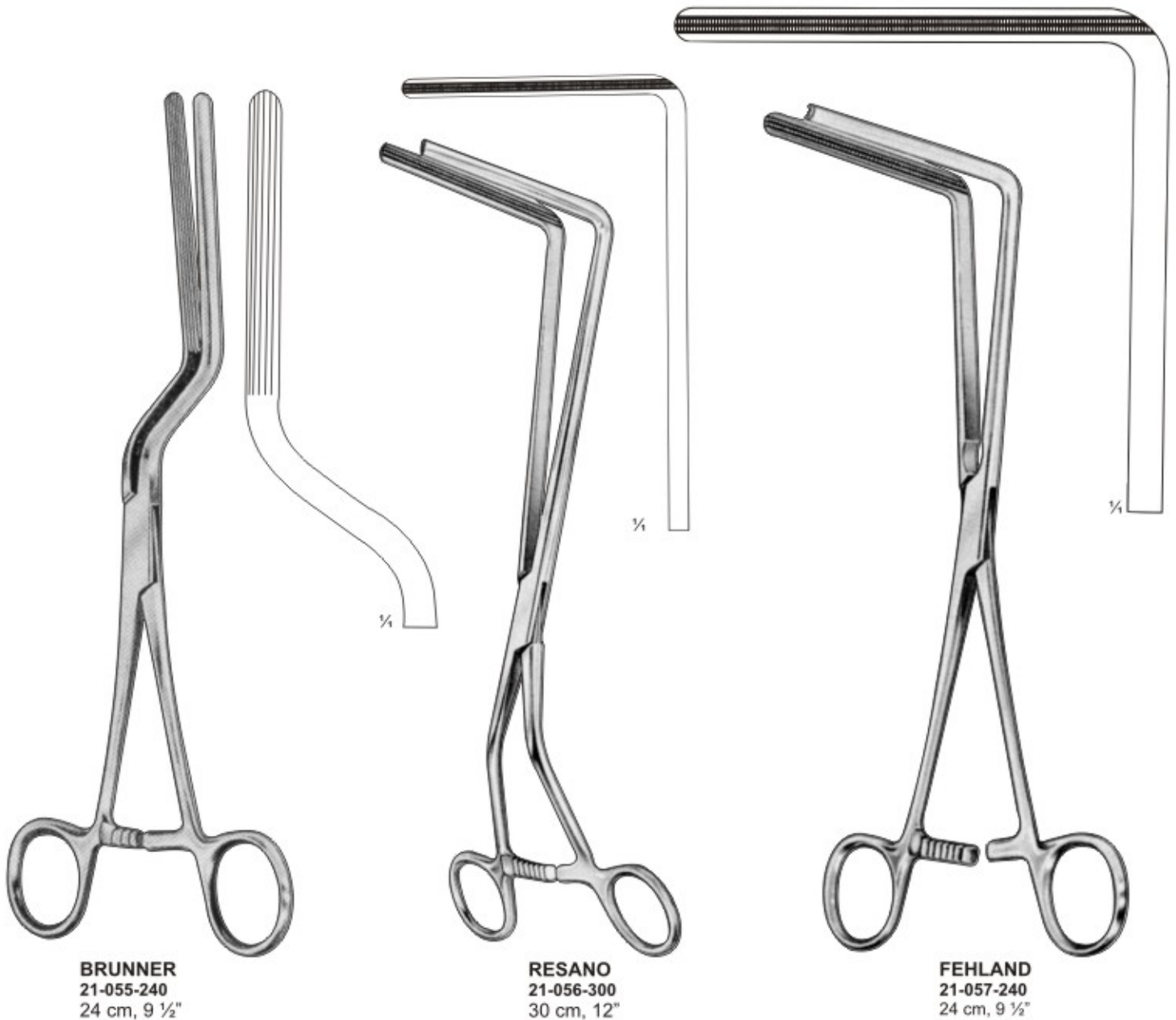

**BRUNNER**  
21-055-240  
24 cm, 9 ½"

**RESANO**  
21-056-300  
30 cm, 12"

**FEHLAND**  
21-057-240  
24 cm, 9 ½"

# INTESTINAL CLAMPS



Darmklemmen  
Pinzas Intestinales

Pinces Intestinales  
Pinze Intestinali

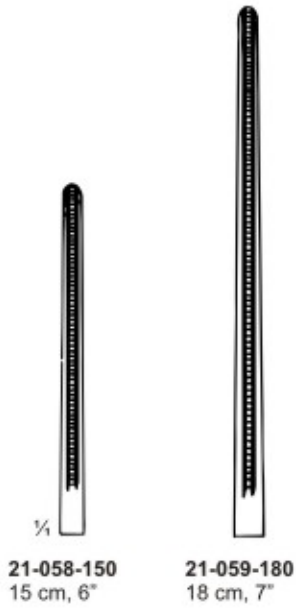

21-058-150  
15 cm, 6"

21-059-180  
18 cm, 7"



BAINBRIDGE

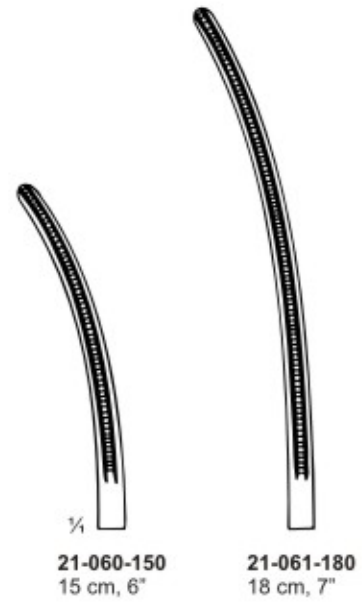

21-060-150  
15 cm, 6"

21-061-180  
18 cm, 7"

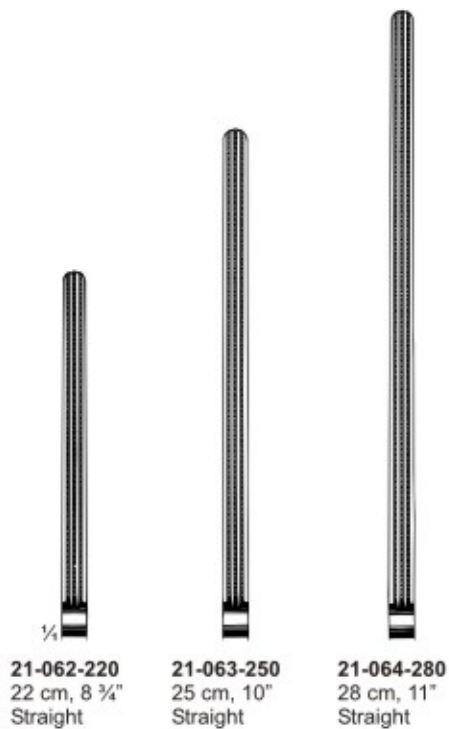

21-062-220  
22 cm, 8 3/4"  
Straight

21-063-250  
25 cm, 10"  
Straight

21-064-280  
28 cm, 11"  
Straight



KOCHER

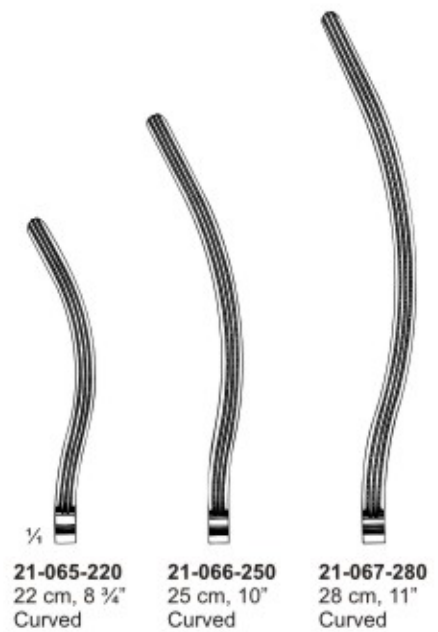

21-065-220  
22 cm, 8 3/4"  
Curved

21-066-250  
25 cm, 10"  
Curved

21-067-280  
28 cm, 11"  
Curved



# INTESTINAL CLAMPS

Darmklemmen  
Pinzas Intestinales

Pinces Intestinales  
Pinze Intestinali



**DOYEN**



21-068-130  
13 cm, 5 1/4"

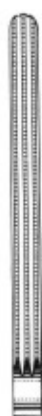

21-069-160  
16 cm, 6 1/4"



21-070-180  
18 cm, 7"



21-071-210  
21 cm, 8 1/4"



21-072-230  
23 cm, 9"



**DOYEN**



21-073-130  
13 cm, 5 1/4"



21-074-160  
16 cm, 6 1/4"



21-075-180  
18 cm, 7"



21-076-210  
21 cm, 8 1/4"



21-077-230  
23 cm, 9"

# INTESTINAL CLAMPS

Darmklemmen  
Pinzas Intestinales

Pinces Intestinales  
Pinze Intestinali



**NUSSBAUM**

21-078-250  
25 cm, 10"

21-079-250  
25 cm, 10"



**SCUDDER**

21-080-250  
25 cm, 10"  
21-081-330  
33 cm, 13"

21-082-250  
25 cm, 10"  
21-083-330  
33 cm, 13"



## POLYOUS GRASPING FORCEPS, ANASTOMOSIS

Polypenfasszange, Darm-anastomosenklemmen

Pince Pour Saisir Polypes, Pincés-clamps Pour Anastomose Intestinale

Pinza Para Coger Pólipos, Clamps Para Anastomosis Intestinales

Pinze Per Afferrare Polipi, Pinze Per Anastomosi Intestinali

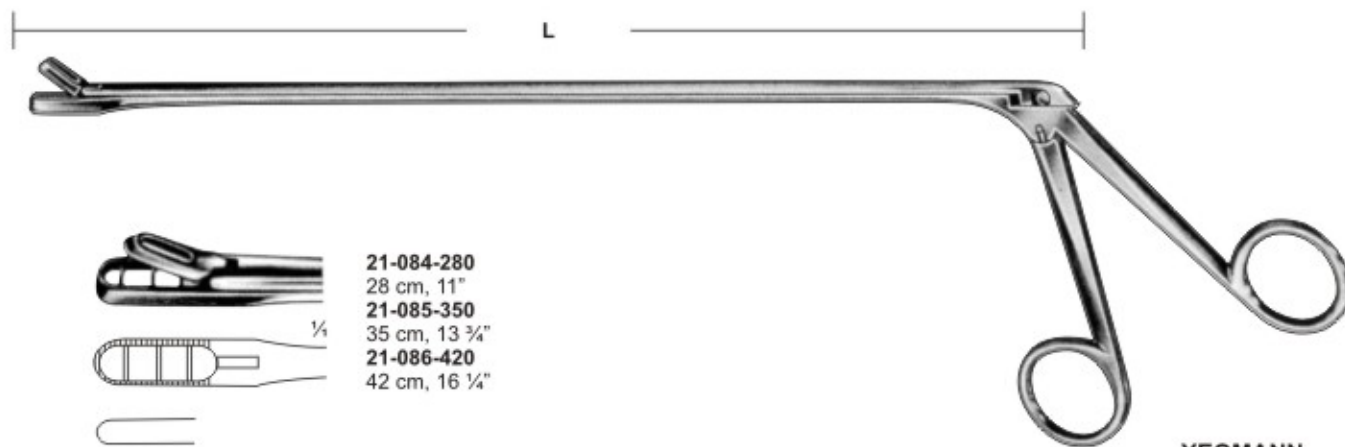

**21-084-280**

28 cm, 11"

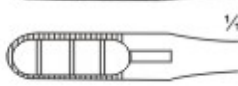

**21-085-350**

35 cm, 13 3/4"



**21-086-420**

42 cm, 16 1/4"



**21-087-280**

28 cm, 11"

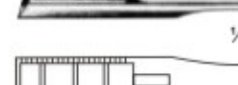

**21-088-350**

35 cm, 13 3/4"

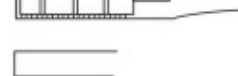

**21-089-420**

42 cm, 16 1/4"



**21-090-280**

28 cm, 11"



**21-091-350**

35 cm, 13 3/4"

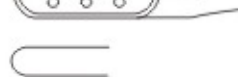

**21-092-420**

42 cm, 16 1/4"



**21-093-280**

28 cm, 11"

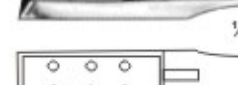

**21-094-350**

35 cm, 13 3/4"



**21-095-420**

42 cm, 16 1/4"

# POLYOUS GRASPING FORCEPS, ANASTOMOSIS



Polypenfasszange, Darm-anastomosenklemmen

Pince Pour Saisir Polypes, Pincés-clamps Pour Anastomose Intestinale

Pinza Para Coger Pólipos, Clamps Para Anastomosis Intestinales

Pinze Per Afferrare Polipi, Pinze Per Anastomosi Intestinali

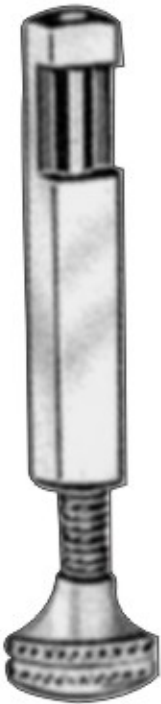

**21-096-085**  
8.5 cm, 3 1/4"



**DE MARTEL-WOLFSON**  
**21-097-230**  
23 cm, 9"



**DE MARTEL-WOLFSON**  
set of 3  
anastomosis clamps



Jaw length  
**21-098-050**  
5 cm, 2"



Jaw length  
**21-099-070**  
7 cm, 2 3/4"



1/4  
Jaw length  
**21-100-100**  
10 cm, 4"



**DE MARTEL-WOLFSON**  
**21-101-260**  
26 cm, 10 1/4"





## INTESTINAL CLAMPS

Darmklemmen  
Pinzas Intestinales

Pinces Intestinales  
Pinze Intestinali



**PAYR-BABY**  
21-102-150  
15 cm, 6"  
without pin  
21-103-150  
15 cm, 6"  
with pin

**PAYR**  
21-104-210  
21 cm, 8 1/4"  
without pin  
21-105-210  
21 cm, 8 1/4"  
with pin

**PAYR**  
21-106-290  
29 cm, 11 1/2"  
without pin  
21-107-290  
29 cm, 11 1/2"  
with pin

**PAYR**  
21-108-350  
35 cm, 13 3/4"  
without pin  
21-109-350  
35 cm, 13 3/4"  
with pin

# INTESTINAL CLAMPS



Darmklemmen  
Pinzas Intestinales

Pinces Intestinales  
Pinze Intestinali

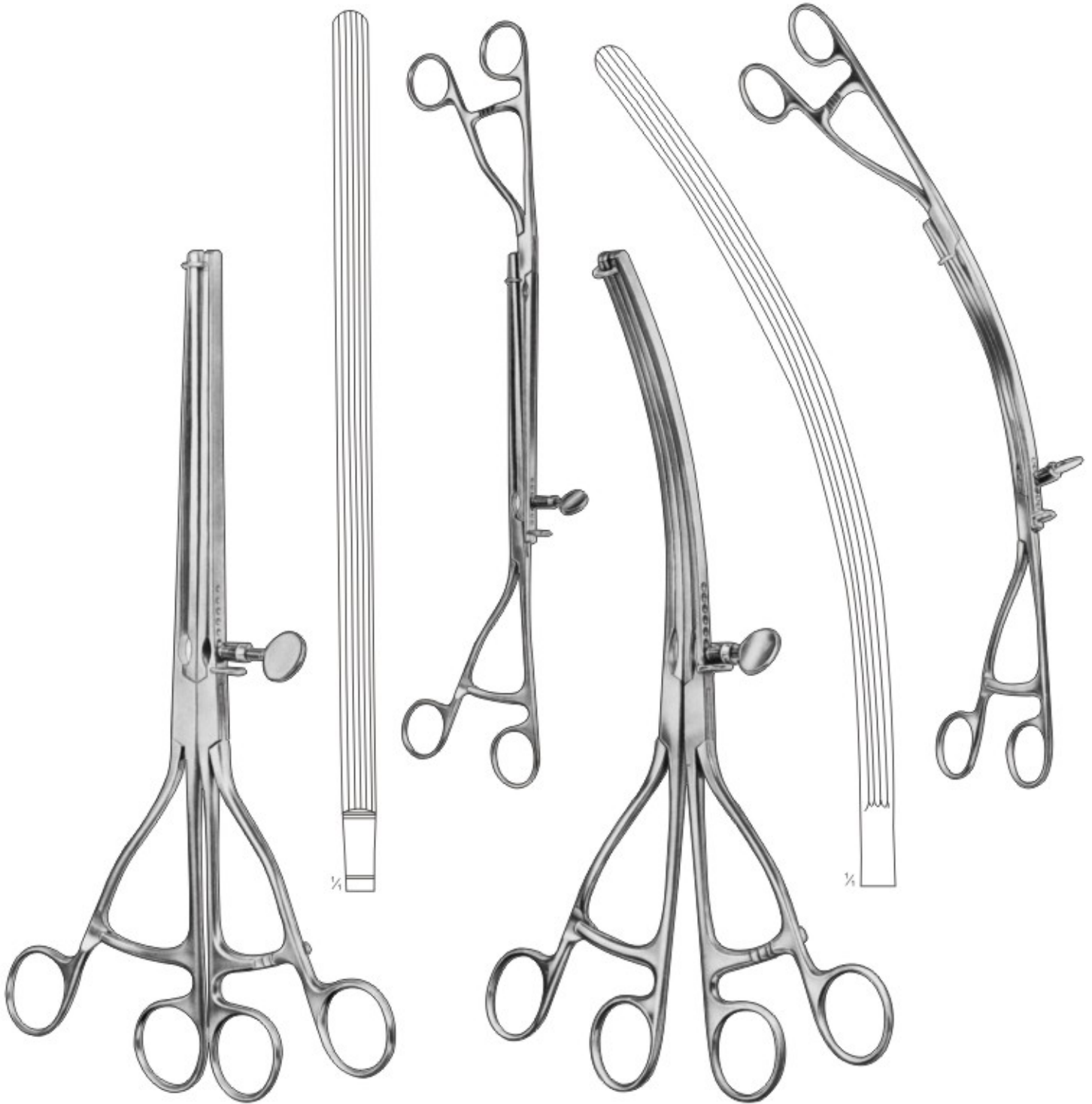

**LANE Str.**  
21-110-300  
30 cm, 12"

**LANE Cvd.**  
21-111-300  
30 cm, 12"



# INTESTINAL CLAMPS

Darmklemmen  
Pinzas Intestinales

Pinces Intestinales  
Pinze Intestinali

## Intestinal & Stomach Twin Clamp Forceps

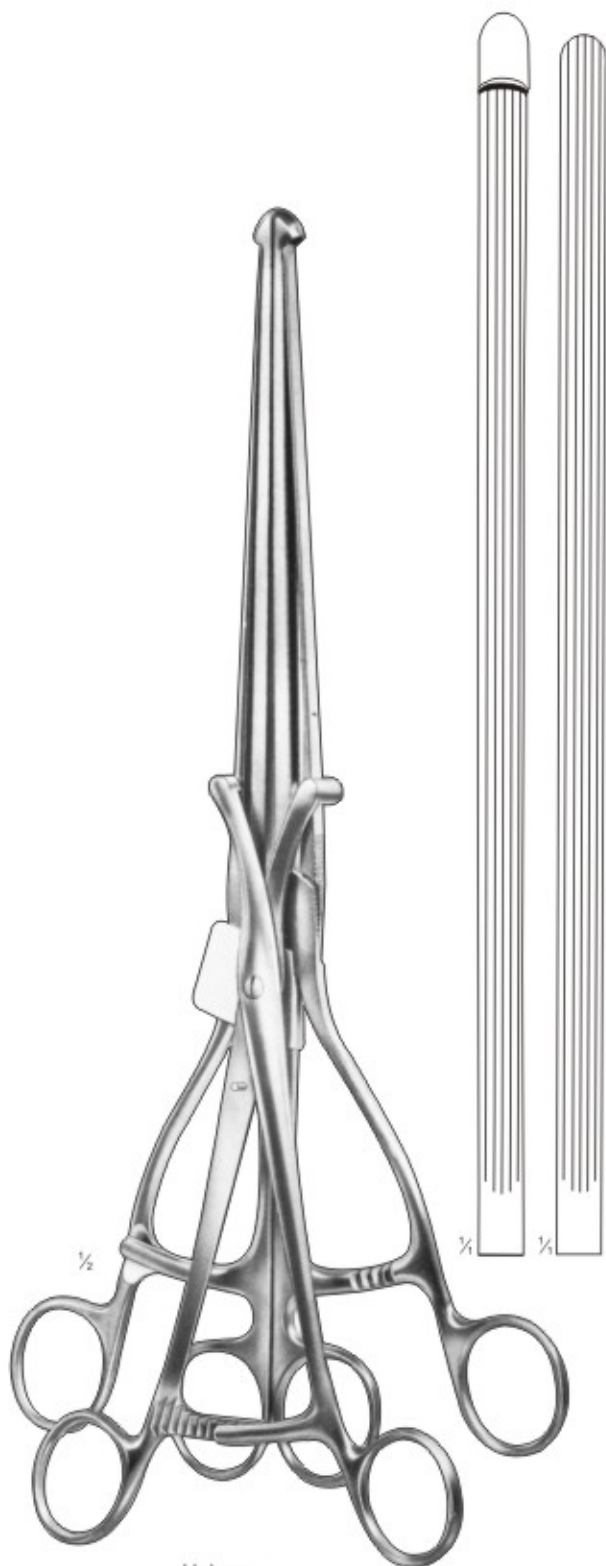

Haberer  
21-112-36  
36cm 14"

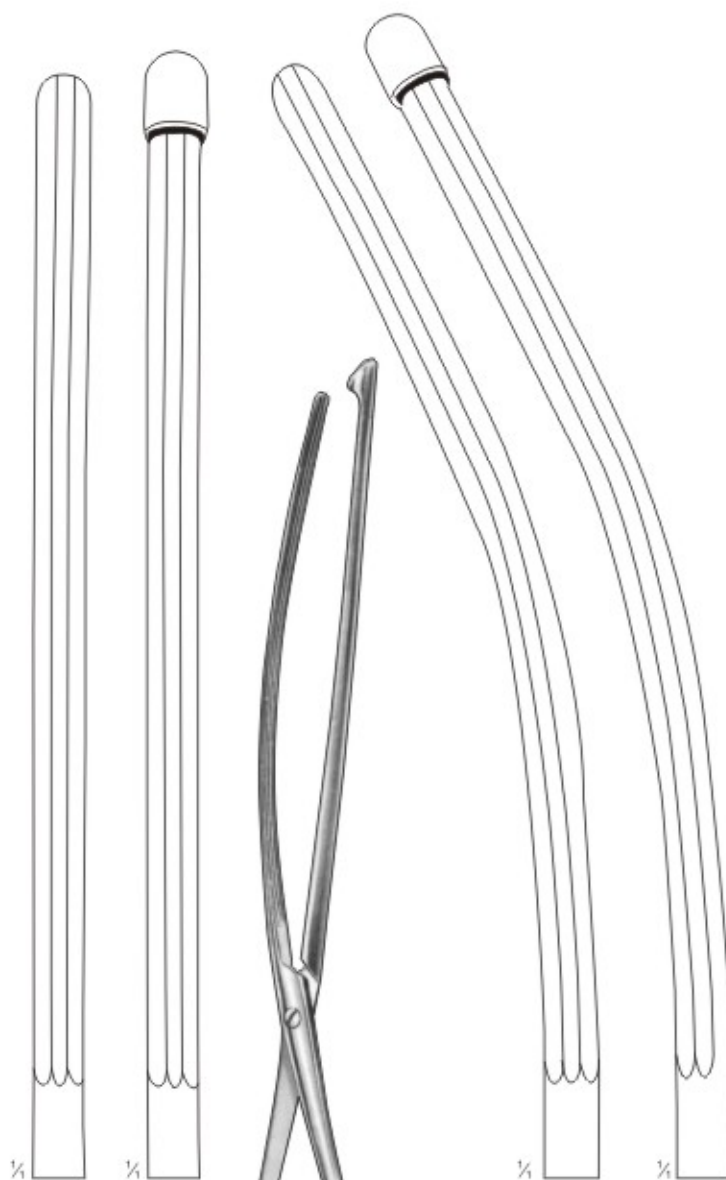

21-113-30

21-114-30

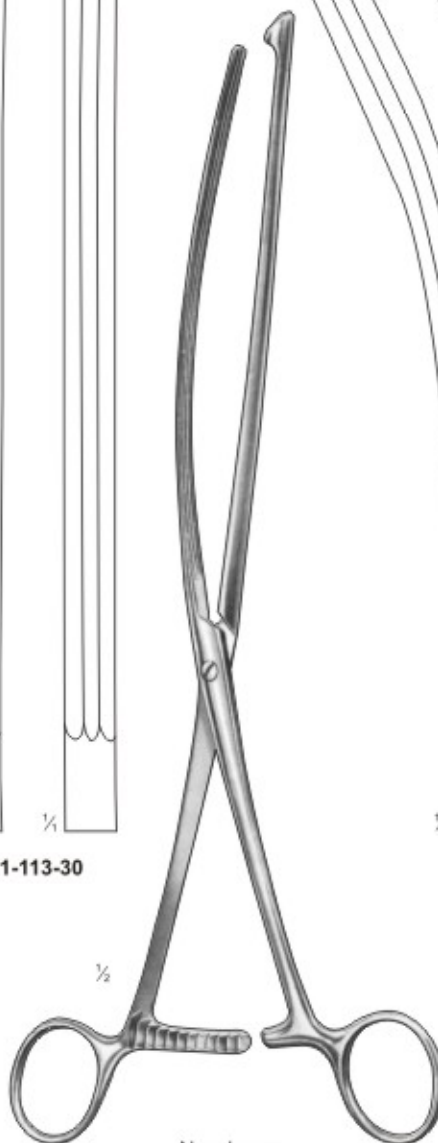

Nussbaum  
30cm 12"



## Intestinal Twin Clamp Forceps

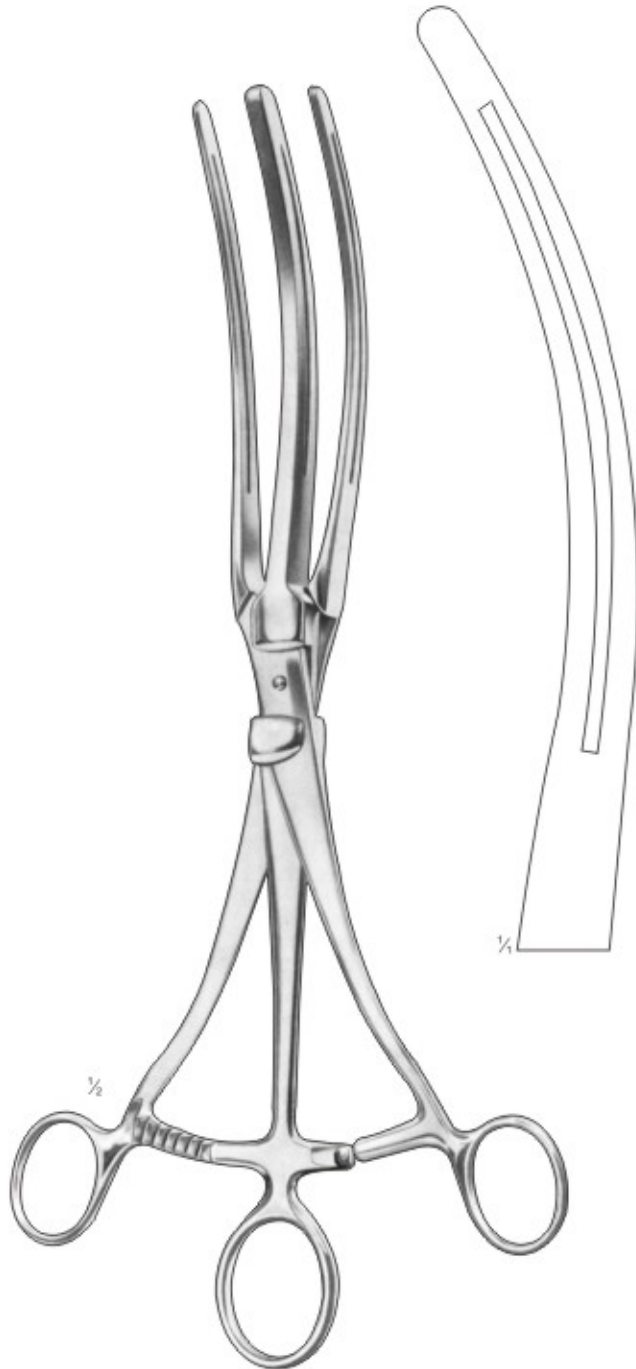

Roosevelt  
21-115-34  
34cm 13 1/2"

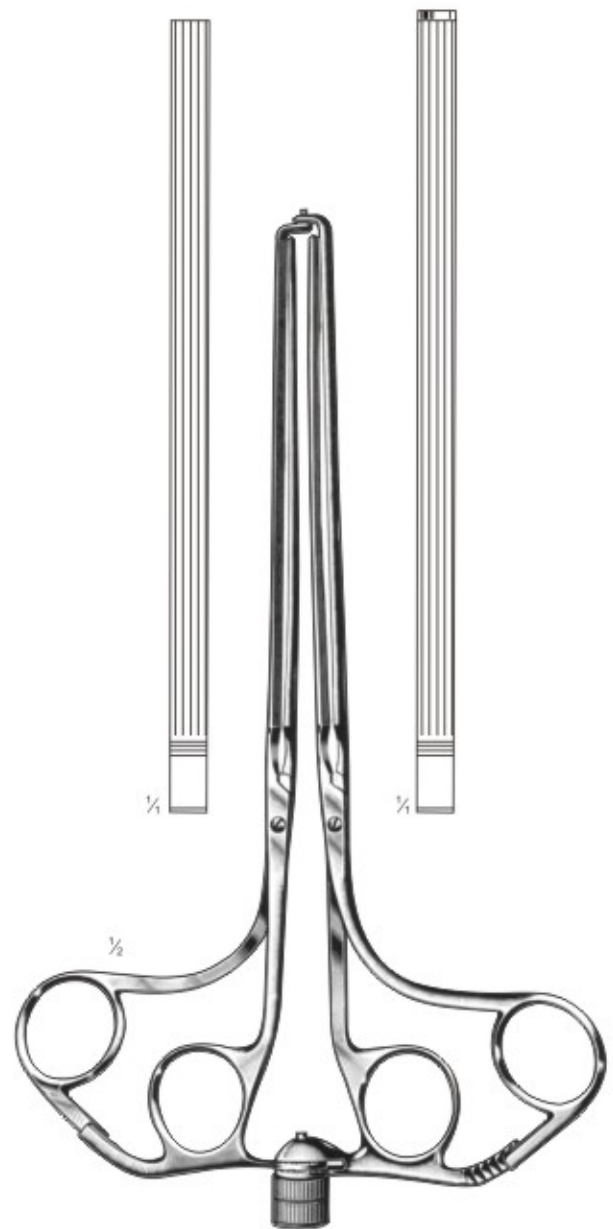

Abadie  
21-116-22  
22cm 8 3/4"  
21-117-27  
27cm 10 1/2"



## INTESTINAL RECTAL SPECULA

Mastdarmspekula  
Espéculos Rectales

Spéculums Rectaux  
Specoli Rettali



90 x 15 mm

**MATHIEU**  
21-118-195  
19.5 cm, 7 3/4"  
90 x 15 mm



**SIMS**  
21-119-150  
15 cm, 6"



**SIMS**  
21-120-150  
15 cm, 6"



**BARR**  
21-121-001  
Blade size  
80 mm



**IVES-FANSLER**  
21-122-154  
14.5 mm, 5 3/4"  
22 mm Ø



**PRATT**  
21-123-215  
21.5 cm, 8 1/2"  
85 x 25 mm blade

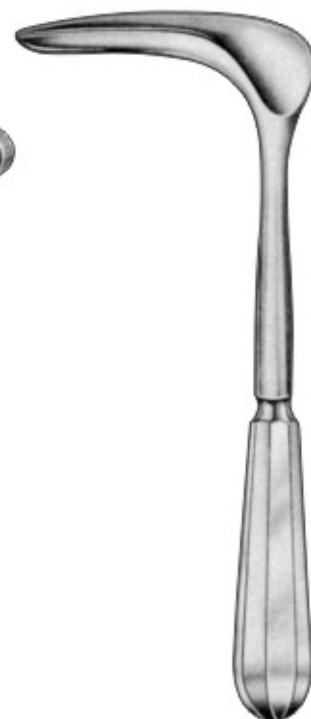

**CZERNY**  
21-124-220  
22 cm, 8 3/4"

# INTESTINAL RECTAL SPECULA

Mastdarmspekula  
Especulos Rectales

Spéculums Rectaux  
Specoli Rettali

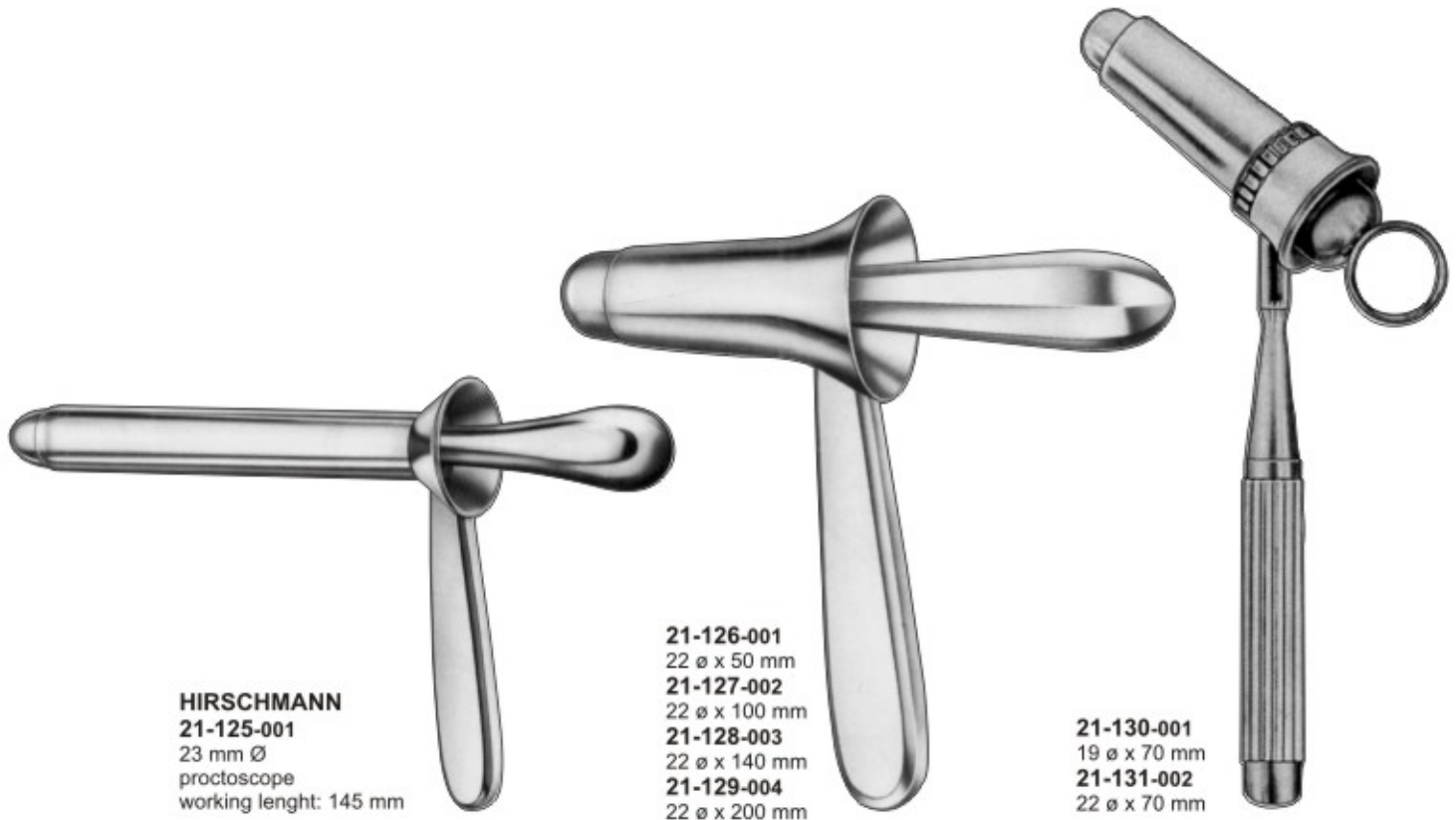

**HIRSCHMANN**  
21-125-001  
23 mm Ø  
proctoscope  
working length: 145 mm

21-126-001  
22 ø x 50 mm  
21-127-002  
22 ø x 100 mm  
21-128-003  
22 ø x 140 mm  
21-129-004  
22 ø x 200 mm

**KELLY**

21-130-001  
19 ø x 70 mm  
21-131-002  
22 ø x 70 mm

**BENSAUDE**

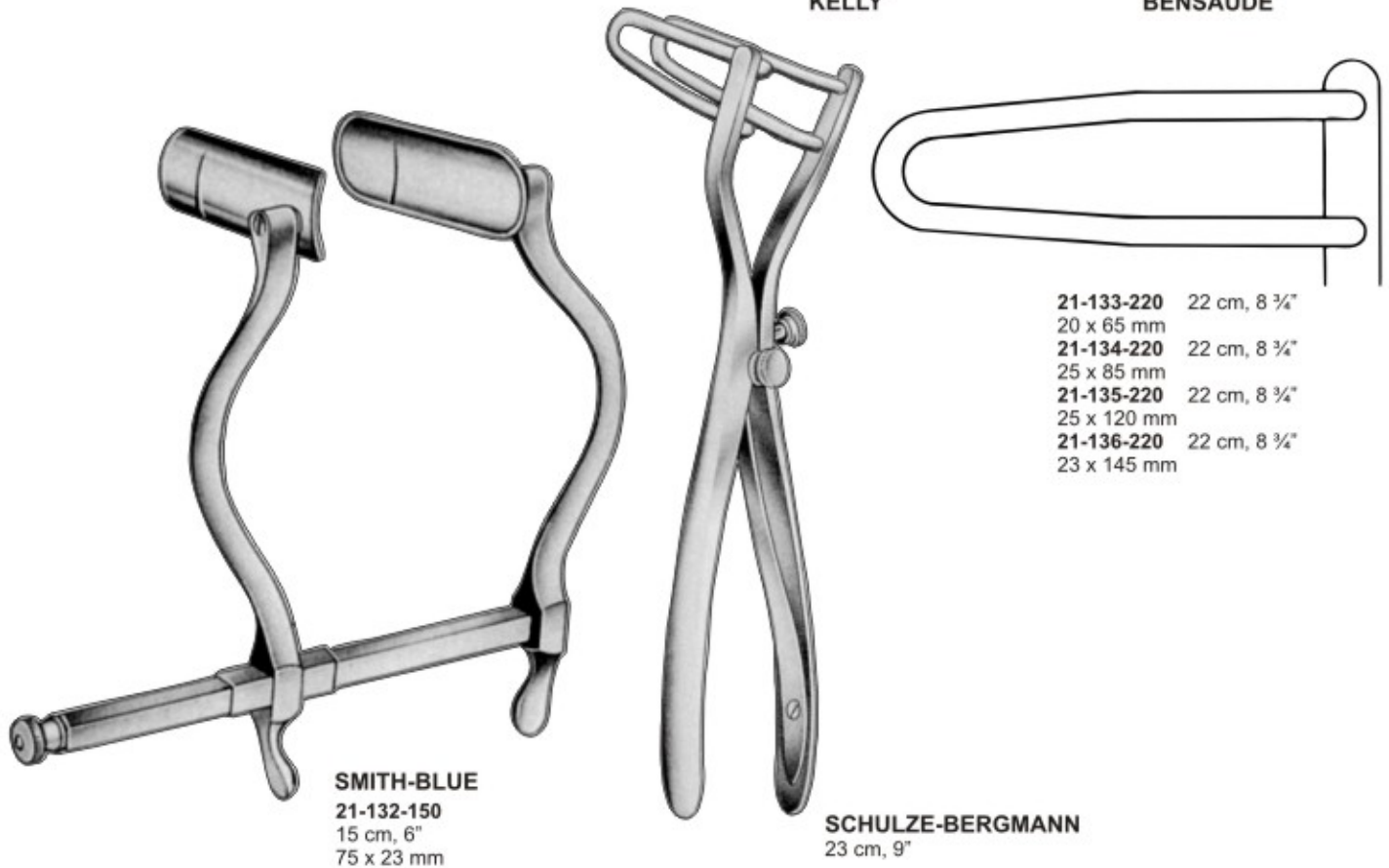

**SMITH-BLUE**  
21-132-150  
15 cm, 6"  
75 x 23 mm

**SCHULZE-BERGMANN**  
23 cm, 9"

21-133-220 22 cm, 8 3/4"  
20 x 65 mm  
21-134-220 22 cm, 8 3/4"  
25 x 85 mm  
21-135-220 22 cm, 8 3/4"  
25 x 120 mm  
21-136-220 22 cm, 8 3/4"  
23 x 145 mm



## INTESTINAL & TISSUE GRASPING FORCEPS

Darm-und Gewebefasszangen  
Pinzas Para Intestinos y Tejidos

Pinces Pour Saisir Intestins et Tissus  
Pinze Per Afferrare Intestino e Tessuti

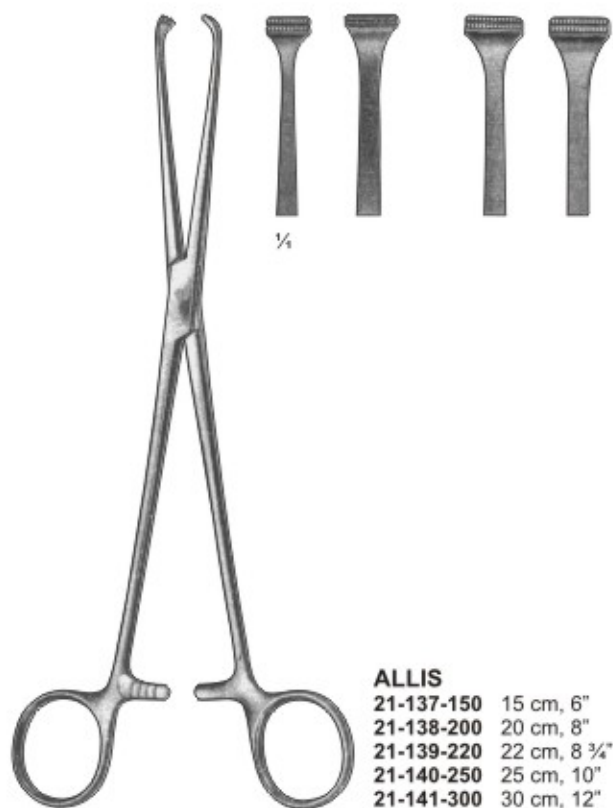

### ALLIS

21-137-150 15 cm, 6"  
21-138-200 20 cm, 8"  
21-139-220 22 cm, 8 3/4"  
21-140-250 25 cm, 10"  
21-141-300 30 cm, 12"



### DUVAL

21-142-250 25 cm, 10"  
21-143-270 27 cm, 10 3/4"

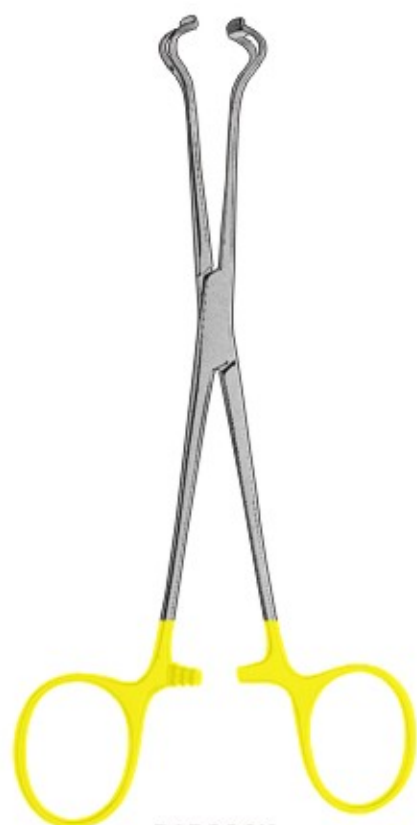

BABCOCK



21-144-165  
16.5 cm, 6 1/2"

21-145-203  
20.3 cm, 8"

21-146-175  
17.5 cm, 7"

21-147-195  
19.5 cm, 8"



DUVAL



21-148-130  
13 cm, 5 1/4"

21-149-180  
18 cm, 7"

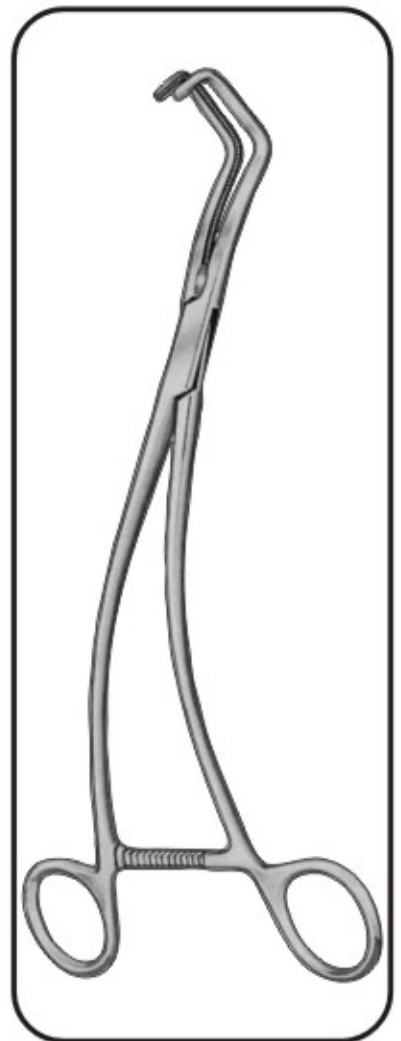
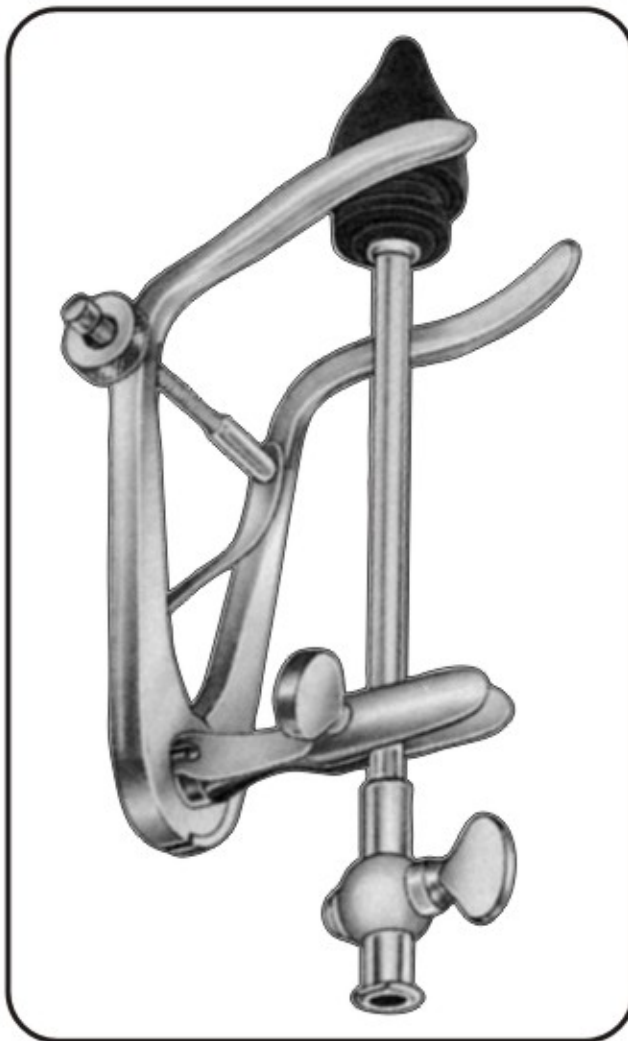
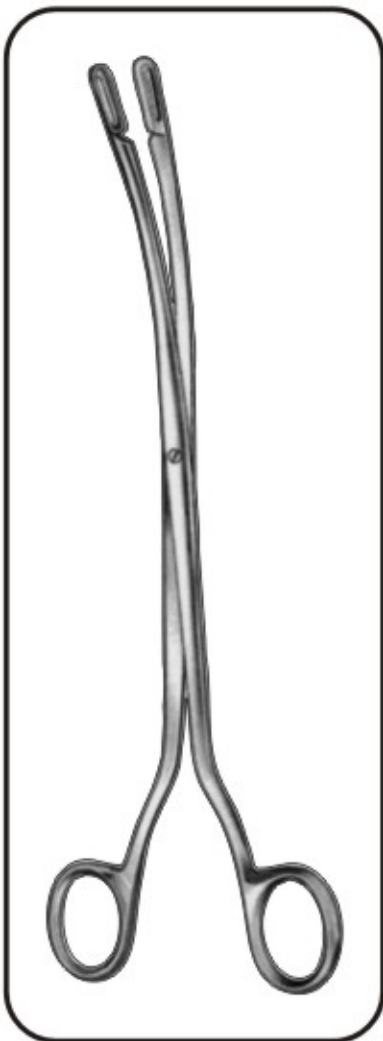





## KIDNEY STONE FORCEPS

Nierensteinzangen  
Pinzas para cálculoa renales

Pinces pour les calculs du bassin  
Pinze per calcoli renali

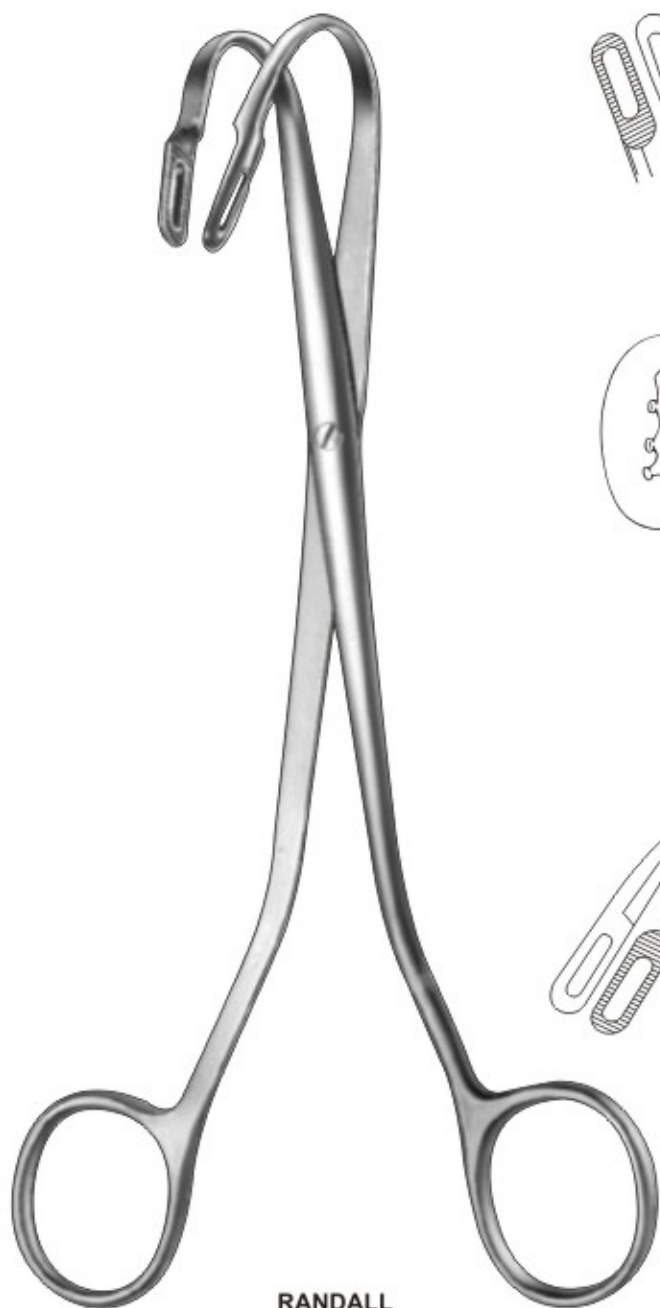

RANDALL

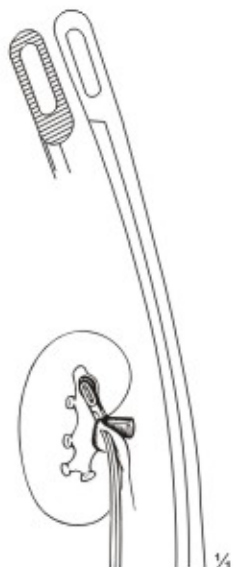

22-001-230  
23 cm, 9"

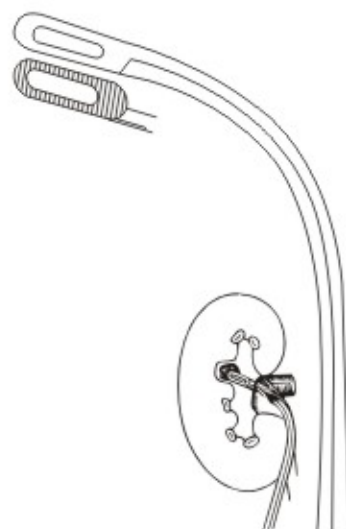

22-002-230  
23 cm, 9"



22-003-230  
23 cm, 9"

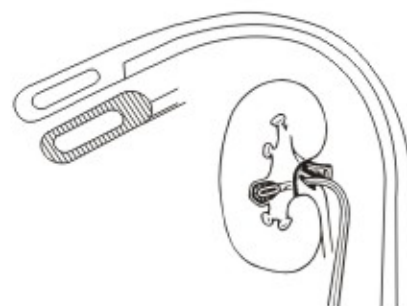

22-004-230  
23 cm, 9"

# KIDNEY STONE FORCEPS



Nierensteinzangen  
Pinzas para cálculoa renales

Pinces pour les calculs du bassin  
Pinze per calcoli renali



**DARTIGUES**  
22-005-270  
27 cm, 10 3/4"



**COLLIN**  
22-006-285  
28.5 cm, 11 1/4"



**HULKA-KENWICK**  
Uterine Elevating &  
Manipulating Forceps  
22-007-273  
27.3 cm, 11"



**SOMER**  
22-008-235  
23.5 cm, 9"



**STRASSMANN**  
22-009-260  
26 cm, 10 1/4"

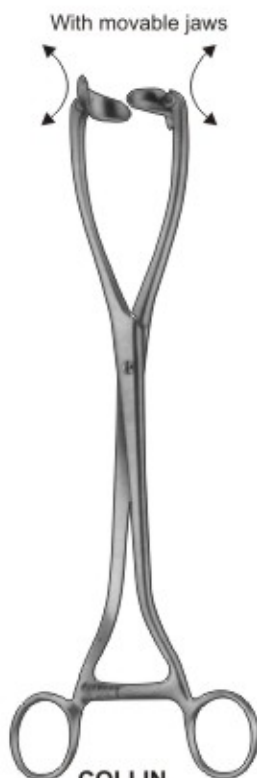

**COLLIN**  
22-010-265  
26.5 cm, 10 1/2"

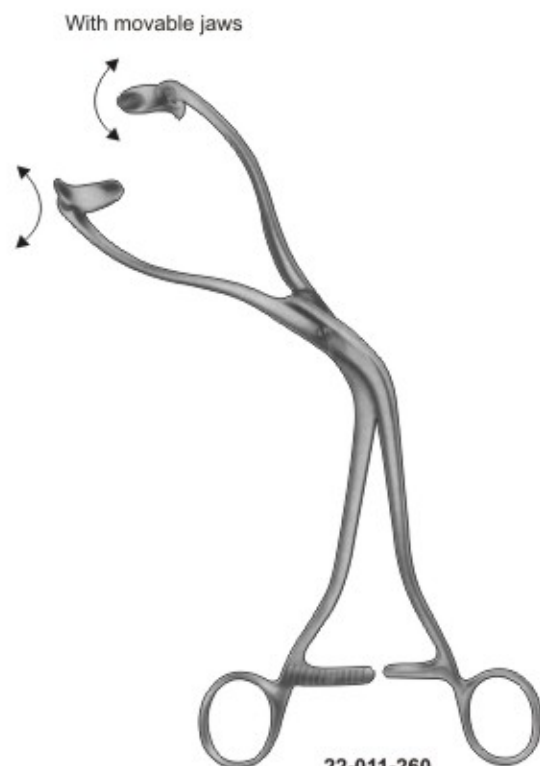

**22-011-260**  
26 cm, 10 1/4"



## PROSTATIC RETRACTOR

Prostatahaken  
Separadores para próstata

Ecarteurs prostatiques  
Divaricatori prostatici

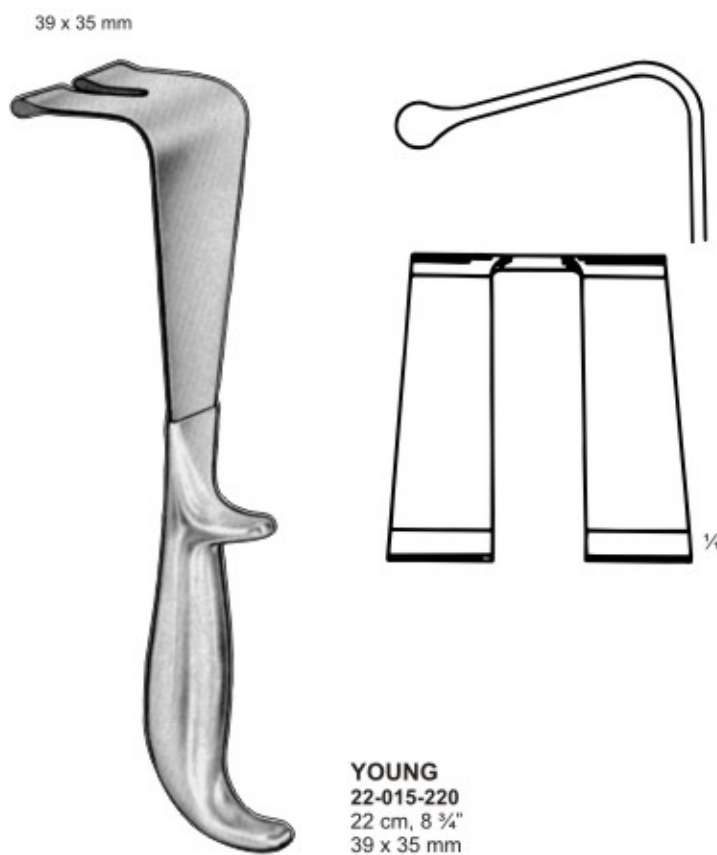
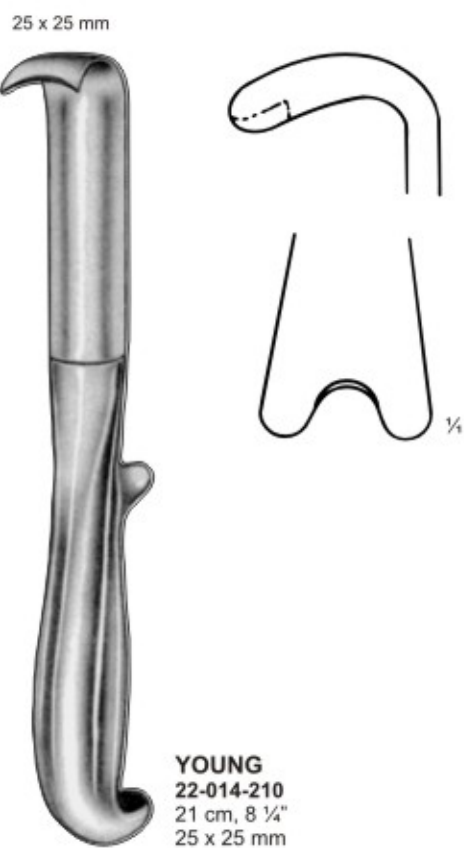
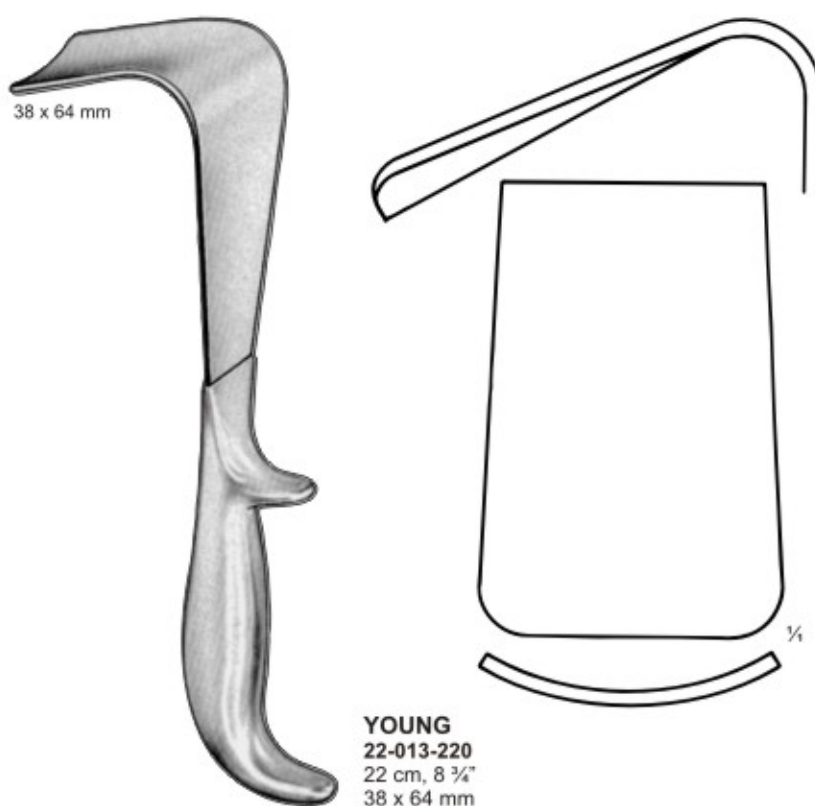
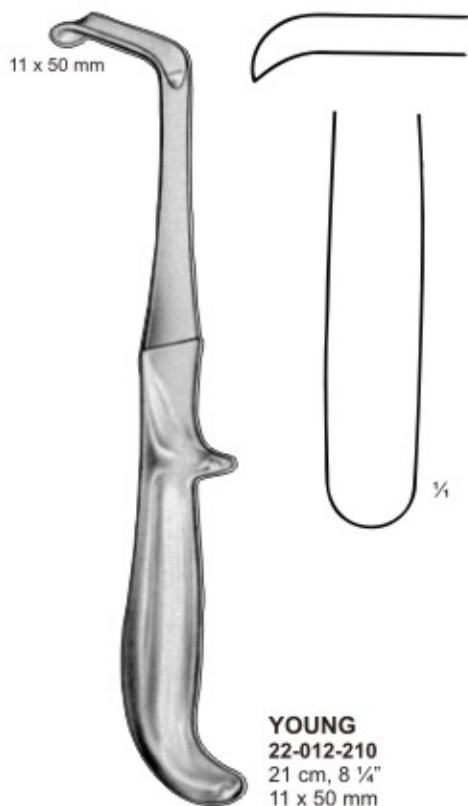

# GALL DUCT DILATOR

Gallenkanaldilatoren  
Gallensteinzangen

Dilatateurs pour les voies biliaires  
Pincés pour calculs biliaires

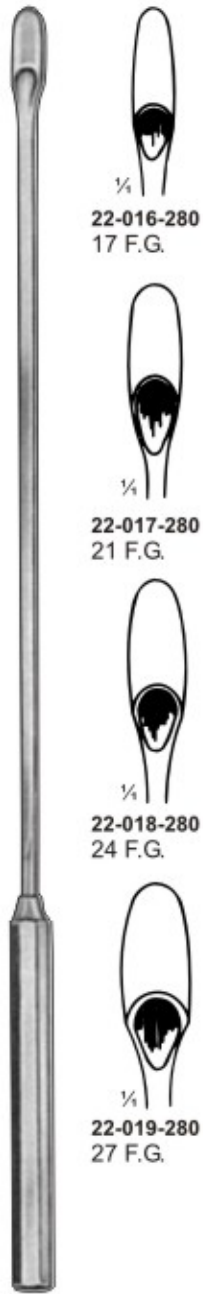

22-016-280  
17 F.G.

22-017-280  
21 F.G.

22-018-280  
24 F.G.

22-019-280  
27 F.G.

28 cm, 11"



**MOYNIHAN**  
22-020-340  
34.0 cm, 13 1/2"



**DESJARDINS**  
22-021-280  
28.0 cm, 11"



**BAKES**  
Set of 13  
32 cm, 13"

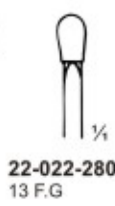

22-022-280  
13 F.G.

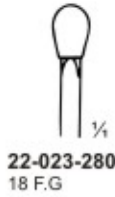

22-023-280  
18 F.G.



22-024-280  
21 F.G.



Fig. 1  
22-025-320



Fig. 2  
22-026-320



Fig. 3  
22-027-320



Fig. 4  
22-028-320



Fig. 5  
22-029-320



Fig. 6  
22-030-320



Fig. 7  
22-031-320



Fig. 8  
22-032-320



Fig. 9  
22-033-320



Fig. 10  
22-034-320



Fig. 11  
22-035-320



Fig. 12  
22-036-320



Fig. 13  
22-037-320



# URETHRAL CATHETERS

Urethalkatheter  
Sondes Urétrales

Cateteri Uretrali  
Catéteres Uretrales



**CATHETER**  
22-038-150  
15 cm, 6"  
No. 6-16



**CATHETERS**  
22-039-290 29 cm, 11 1/2"  
Male Catheters charr., Metal  
French  
22-040-01 8  
22-041-02 10  
22-042-03 12  
22-043-04 14  
22-044-05 16  
22-045-06 18  
22-046-07 20



**LISTER BOUGIES**  
22-047-270  
27 cm, 10 3/4"  
00 / 1 to 15 / 18  
set of 17



**CLUTTON BOUGIES**  
22-048-270 27 cm, 10 3/4"  
06 / 10 FG to 28 / 32  
set of 12



**VAN BUREN**  
A TO O  
Set of 15

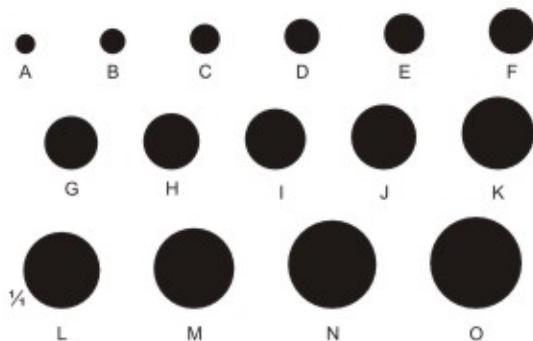
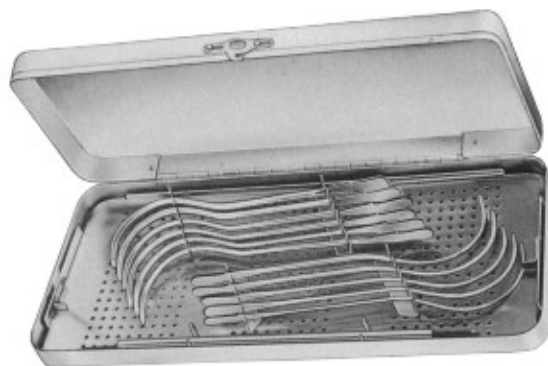

Fig.	Item	Description	Inches	Dia. Charr
A	22-049-280	28 cm	11"	8 French
B	22-050-280	28 cm	11"	10 French
C	22-051-280	28 cm	11"	12 French
D	22-052-280	28 cm	11"	14 French
E	22-053-280	28 cm	11"	16 French
F	22-054-280	28 cm	11"	18 French
G	22-055-280	28 cm	11"	20 French
H	22-056-280	28 cm	11"	22 French
I	22-057-280	28 cm	11"	24 French
J	22-058-280	28 cm	11"	26 French
K	22-059-280	28 cm	11"	28 French
L	22-060-280	28 cm	11"	30 French
M	22-061-280	28 cm	11"	32 French
N	22-062-280	28 cm	11"	34 French
O	22-063-280	28 cm	11"	36 French



**GUYON**  
22-064-001  
420 x 175 x 40 mm  
Set in metal case containing:  
— 21 Bougies Guyon  
— 6 filiform Bougies

# URETHRAL CATHETERS



Urethalkatheter  
Sondes Urétrales

Cateteri Uretrali  
Catéteres Uretrales



	Charr. (French)
22-066-008	8
22-067-009	9
22-068-010	10
22-069-011	11
22-070-012	12
22-071-013	13
22-072-014	14
22-073-015	15
22-074-016	16
22-075-017	17
22-076-018	18
22-077-019	19
22-078-020	20
22-079-021	21
22-080-022	22
22-081-023	23
22-082-024	24
22-083-025	25
22-084-026	26
22-085-027	27
22-086-028	28
22-087-029	29
22-088-030	30

**DITTEL**  
22-065-225  
22.5 cm, 8 3/4"  
urethral bougies and  
dilating sounds



	Charr. (French)
22-090-008	8
22-091-009	9
22-092-010	10
22-093-011	11
22-094-012	12
22-095-013	13
22-096-014	14
22-097-015	15
22-098-016	16
22-099-017	17
22-100-018	18
22-101-019	19
22-102-020	20
22-103-021	21
22-104-022	22
22-105-023	23
22-106-024	24
22-107-025	25
22-108-026	26
22-109-027	27
22-110-028	28
22-111-029	29
22-112-030	30

**DITTEL**  
22-089-350  
35 cm, 14"  
urethral bougies and  
dilating sounds



	Charr. (French)
22-114-330	3
22-115-330	4
22-116-330	5
22-117-330	6

**22-113-330**  
33 cm, 13"  
filiform guides,  
olive tip



	Charr. (French)
22-119-008	Ben. 24 / Charr. 12
22-120-009	Ben. 25
22-121-010	Ben. 26 / Charr. 13
22-122-011	Ben. 27
22-123-012	Ben. 28 / Charr. 14
22-124-013	Ben. 29
22-125-014	Ben. 30 / Charr. 15
22-126-015	Ben. 31
22-127-016	Ben. 32 / Charr. 16
22-128-017	Ben. 33
22-129-018	Ben. 34 / Charr. 17
22-130-019	Ben. 35
22-131-020	Ben. 36 / Charr. 18
22-132-021	Ben. 37
22-133-022	Ben. 38 / Charr. 19
22-134-023	Ben. 39
22-135-024	Ben. 40 / Charr. 20
22-136-025	Ben. 41
22-137-026	Ben. 42 / Charr. 21
22-138-027	Ben. 43
22-139-028	Ben. 44 / Charr. 22
22-140-029	Ben. 45
22-141-030	Ben. 46 / Charr. 23
22-142-031	Ben. 47
22-143-032	Ben. 48 / Charr. 24
22-144-033	Ben. 49
22-145-034	Ben. 50 / Charr. 25
22-146-035	Ben. 51
22-147-036	Ben. 52 / Charr. 26
22-148-037	Ben. 53
22-149-038	Ben. 54 / Charr. 27
22-150-039	Ben. 55
22-151-040	Ben. 56 / Charr. 28
22-152-041	Ben. 57
22-153-042	Ben. 58 / Charr. 29
22-154-043	Ben. 59
22-155-044	Ben. 60 / Charr. 30

**GUYON**  
22-118-250  
25 cm, 10"  
urethral bougies and  
dilating sounds  
without filiform guides,  
with thread in tip



## GALL STONE FORCEPS

Gallensteinzangen  
Gallensteinlöffel

Pinces pour calculs biliaires  
Curettes pour calculs biliaires



**BLAKE**  
22-156-200 20 cm, 8"



**BLAKE**  
22-157-200 20 cm, 8"



**MAYO-BLAKE**  
22-158-200 20 cm, 8"



**MAYO-BLAKE**  
22-159-200 20 cm, 8"

# GALL STONE FORCEPS



Gallensteinzangen  
Gallensteinlöffel

Pinces pour calculs biliaires  
Curettes pour calculs biliaires



**URO-TANGENTIAL**

22-160-260  
26 cm, 10 1/4"



22-161-260  
26 cm, 10 1/4"



**MIXTER**  
22-162-220 22 cm, 8 3/4"

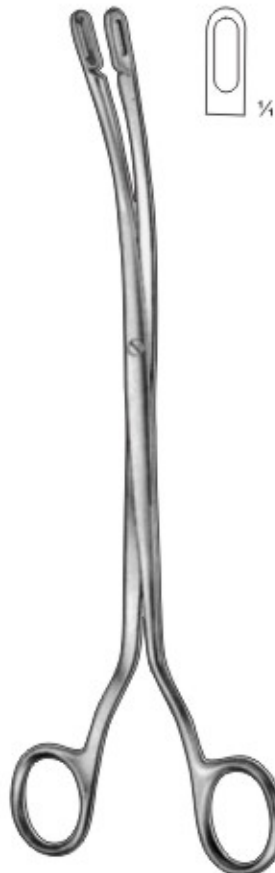

**DESJARDINS**  
22-163-230 23 cm, 9"



**DESJARDINS**  
22-164-230 23 cm, 9"





## CAPSULE FORCEPS, LIGATURE CARRYING FORCEPS

Kapselasszangen, Fadenführungszange  
Pinzas capsulares, Pinza porta ligaduras

Pinces pour saisir les capsules, Pince porte-fil  
Pinze per afferrare capsule, Pinza porta-filo



22-165-241  
24.1 cm, 9 1/2"

**HARRIS**  
Angled Suture



22-166-292  
29.2 cm, 12"

**JOHNSON PROSTATIC**  
NEEDLE HOLDER



22-167-230  
23 cm, 9"

**STRATTE NEEDLE HOLDER**



**MILLIN**  
22-168-240  
24 cm, 9 1/2"



**MILLIN**  
22-169-230  
23 cm, 9"



**MILLIN**  
22-170-230  
23 cm, 9"



**MILLIN**  
22-171-230  
23 cm, 9"

# BLADDER NECK SPREADER, BLADDER RETRACTORS



Blasenhalsperrer, Blasenwundsperrer

Ecarteur pour le col de la vessie, Ecarteurs vésicaux

Dilatador para el cuello vesical, Separadores vesicales

Divaricatore del collo vescicale, Divaricatore vescicale

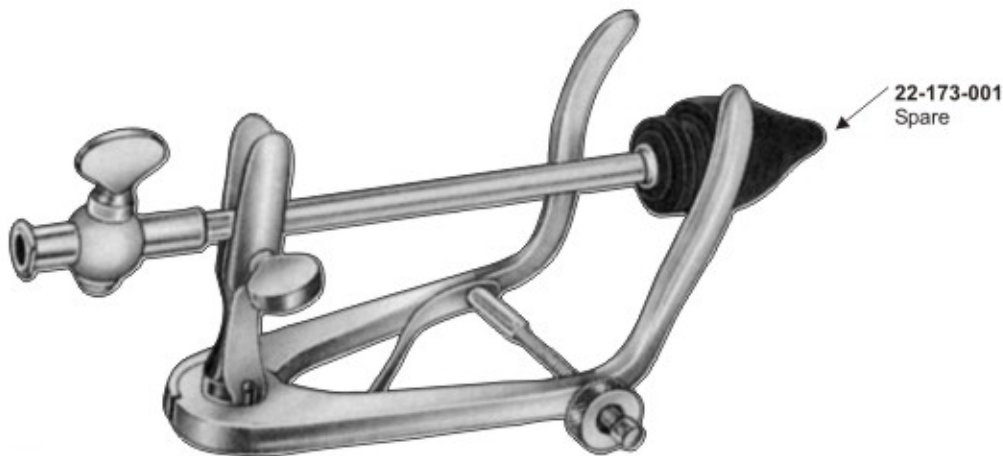

22-173-001  
Spare

**KNUTSON**  
22-172-180  
18 cm, 7"  
Urethrographie-Instruments



**MOGEN CIRCUMCISION CLAMP**  
22-174-001

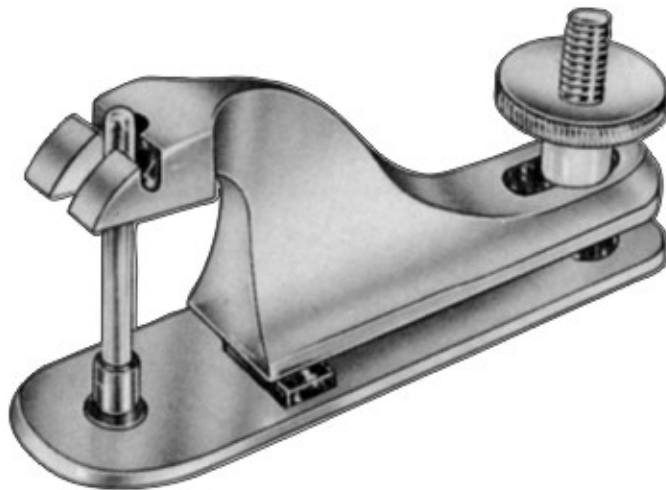

**GUMCO CLAMP**

	mm Ø
22-175-008	8
22-176-011	11
22-177-013	13
22-178-016	16
22-179-021	21
22-180-026	26
22-181-032	32

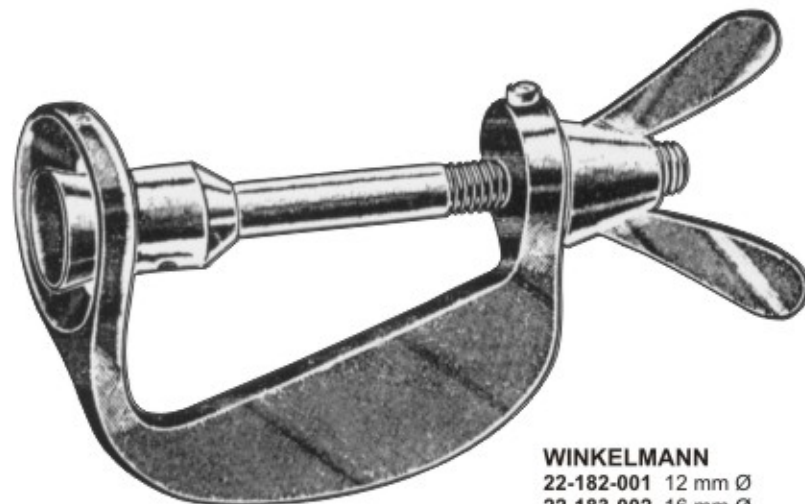

**WINKELMANN**  
22-182-001 12 mm Ø  
22-183-002 16 mm Ø  
22-184-003 20 mm Ø  
Circumcision clamps



**MILLIN**  
22-185-280  
28 cm, 11"



# GYNECOLOGY / OBSTETRICS

---

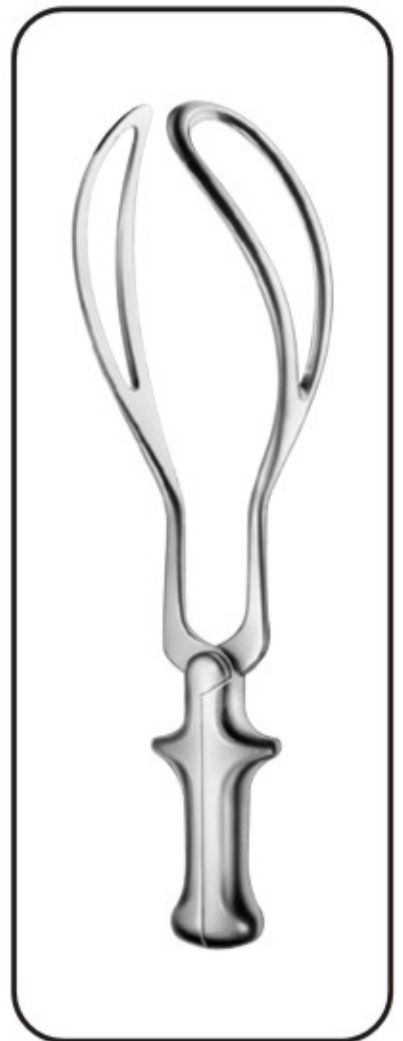

# VAGINAL SPECULA

Vaginalspekula  
Especulos vaginales

Spéculums vaginaux  
Specoli vaginali



**GRAVES**  
23-001-001  
75 x 20 mm Small  
23-002-002  
95 x 35 mm Medium  
23-003-003  
115 x 35 mm Large

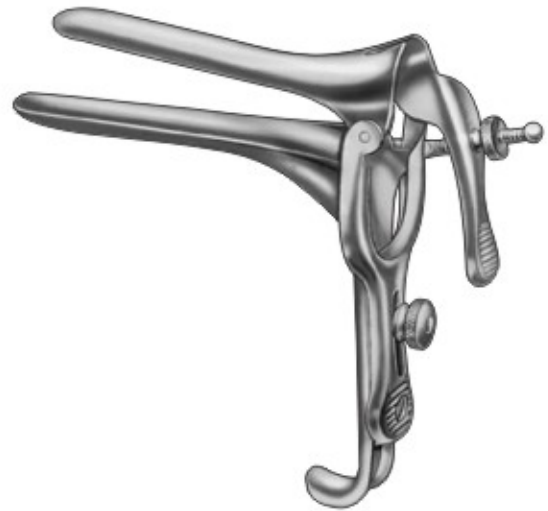

**PEDERSON**  
23-004-001  
75 x 13 mm Small  
23-005-002  
100 x 22 mm Medium  
23-006-003  
120 x 25 mm Large



**Graves Vaginal  
Speculum Leep / Lietz**  
23-007-004 Small  
23-008-005 Medium  
23-009-006 Large  
23-010-007 X-large



**Pederson Vaginal  
Speculum Leep / Lietz**  
23-011-008 Small  
23-012-009 Medium  
23-013-010 Large  
23-014-011 X-Large



## VAGINAL SPECULA

Vaginalspekula  
Espéculos vaginales

Spéculums vaginaux  
Specoli vaginali



**DE VILBISS**  
23-015-001  
4 x 27 mm  
102 mm x 32 mm  
Medium



**SEYFFERT**  
23-016-230 100 x 24 mm  
23-017-230 110 x 32 mm  
23 cm, 9"



**CUSCO**  
23-018-001 75 x 32 mm  
23-019-002 85 x 35 mm  
23-020-003 100 x 35 mm



**CUSCO**  
23-021-004 75 x 17 mm



**CUSCO**  
23-022-001 90 x 22 mm  
23-023-002 100 x 25 mm  
23-024-003 105 x 27 mm

# VAGINAL SPECULA

Vaginalspekula  
Espéculos vaginales

Spéculums vaginaux  
Specoli vaginali



## CUSCO

23-026-001 75 x 32 mm  
23-027-002 85 x 35 mm  
23-028-003 100 x 37 mm



## COLLIN

23-029-001 85 x 30 mm  
23-030-002 100 x 35 mm  
23-031-003 110 x 40 mm

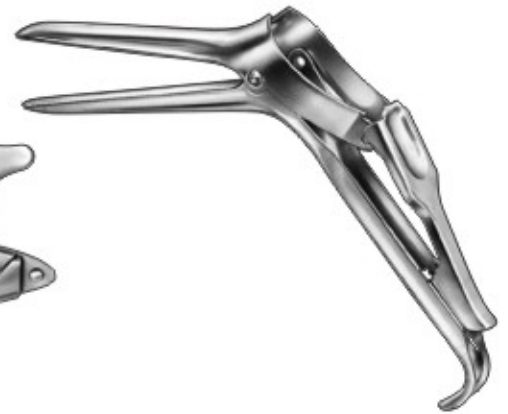

## SEMM

23-032-001 100 x 17 / 20 mm  
23-033-002 105 x 27 / 30 mm

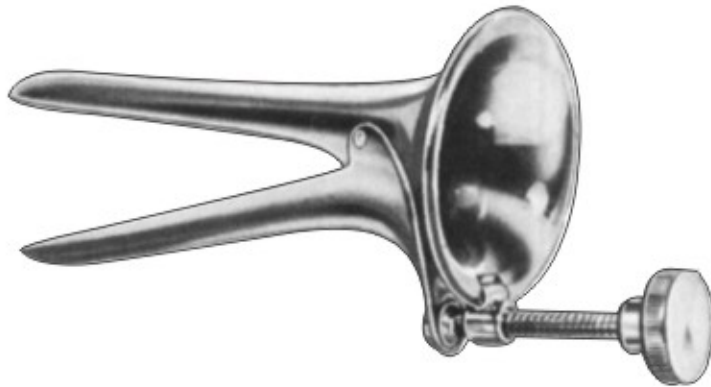

## COLLIN

23-034-001  
55 x 10 mm



## TRELAT

23-035-001 85 mm 33 mm  
23-036-002 95 mm 35 mm  
23-037-003 115 mm 43 mm



WINTERTON  
23-038-001



## NOTT

23-039-001 90 mm 30 mm  
23-040-002 100 mm 30 mm



## VAGINAL SPECULA-SETS

Vaginalspekula  
Espéculos vaginales

Spéculums vaginaux  
Specoli vaginali

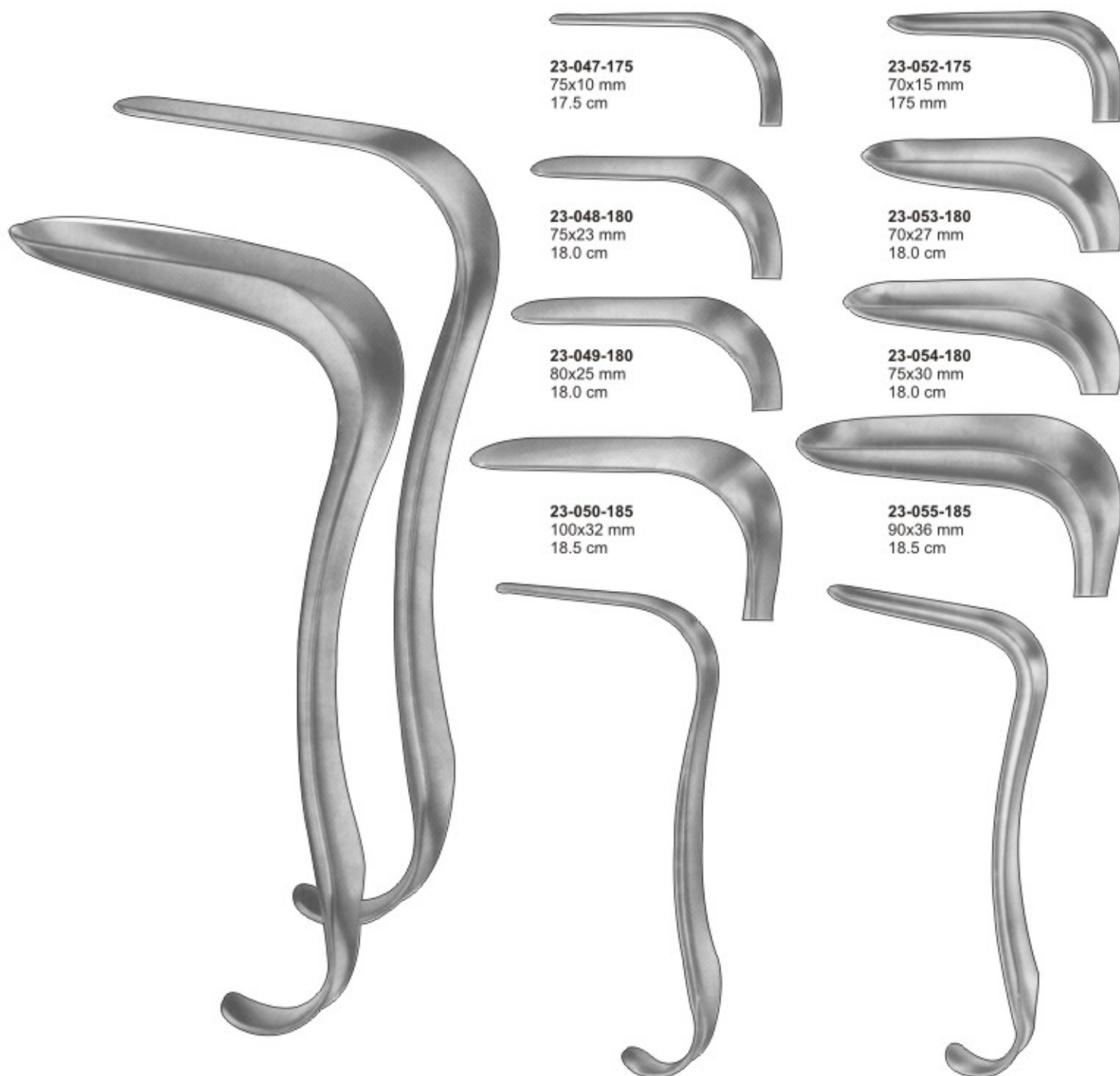

**23-047-175**  
75x10 mm  
17.5 cm

**23-052-175**  
70x15 mm  
175 mm

**23-048-180**  
75x23 mm  
18.0 cm

**23-053-180**  
70x27 mm  
18.0 cm

**23-049-180**  
80x25 mm  
18.0 cm

**23-054-180**  
75x30 mm  
18.0 cm

**23-050-185**  
100x32 mm  
18.5 cm

**23-055-185**  
90x36 mm  
18.5 cm

### KRISTELLER

**23-041-220** 110x18 mm  
**23-042-220** 110x20 mm  
**23-043-220** 110x27 mm  
**23-044-220** 110x30 mm  
**23-045-220** 110x36 mm  
22.0 cm,

### KRISTELLER

**23-046-001**  
Upper Blades

### KRISTELLER

**23-051-001**  
Lower Blades

# VAGINAL SPECULA (UPPER AND LOWER BLADES)

Vaginalspekula  
Espéculos vaginales

Spéculums vaginaux  
Specoli vaginali



**23-057-215**  
115x14 mm  
21.5 cm

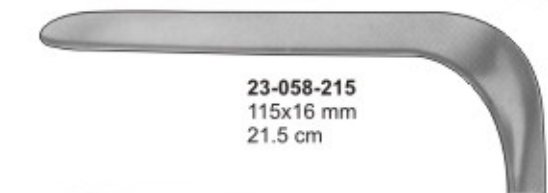

**23-058-215**  
115x16 mm  
21.5 cm

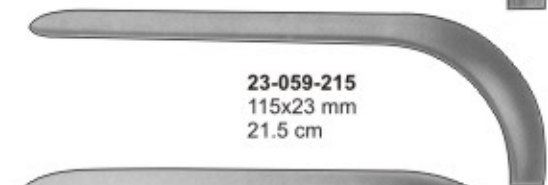

**23-059-215**  
115x23 mm  
21.5 cm



**23-060-215**  
115x26 mm  
21.5 cm

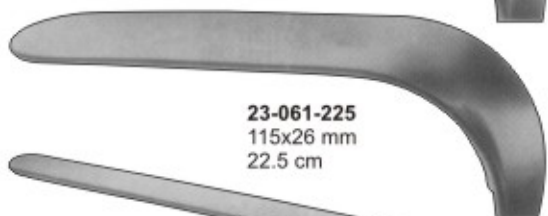

**23-061-225**  
115x26 mm  
22.5 cm



**KRISTELLER**  
**23-056-001**  
Upper Blades



**23-063-215**  
110x18 mm  
21.5 cm



**23-064-215**  
110x20 mm  
21.5 cm



**23-065-215**  
110x27 mm  
21.5 cm



**23-066-225**  
110x30 mm  
22.0 cm



**23-067-225**  
110x36 mm  
22.5 cm



**KRISTELLER**  
**23-062-001**  
Lower Blades





## VAGINAL SPECULA

Vaginalspekula  
Espéculos vaginales

Spéculums vaginaux  
Specoli vaginali



**23-069-205**  
80 x 28 mm



**23-070-205**  
85 x 35 mm



**23-071-205**  
85 x 40 mm



Slightly Concave

**KRISTELLER**  
**23-068-205**  
20.5 cm, 8"



**23-073-175**  
76 x 38 mm



**23-074-175**  
89 x 38 mm



**23-075-175**  
102 x 38 mm



Slightly Concave

**JACKSON**  
**23-072-175**  
17.5 cm, 7"

# VAGINAL SPECULUM



Vaginalspekula  
Espéculos vaginales

Spéculums vaginaux  
Specoli vaginali

56 x 13 mm



**BRAUN**  
23-076-180  
18 cm, 7"

60 x 10 mm



**BRAUN**  
23-077-180  
18 cm, 7"



**23-078-280**  
Handle with cold light  
carrier for upper blades  
28 cm, 11"



**SIMON**  
23-079-275  
115 x 22 mm  
27.5 cm, 10 3/4"

95 x 17-26 mm



**MATHIEU**  
23-080-210  
For children and  
virgins fitting  
21 cm, 8 1/2"

95 x 17 - 30 mm



**MATHIEU**  
23-081-210  
For children  
and virgins  
21 cm, 8 1/2"



## VAGINAL SPECULA, VAGINAL RETRACTORS

Vaginalspekula, scheidenhalter  
Especulos vaginales, valvas vaginales

Spéculums vaginaux, valves vaginales  
Specoli vaginali, valve vaginali

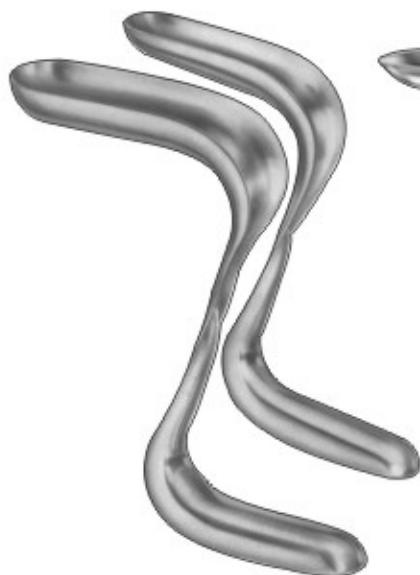

### BRIESKY

23-082-170  
72x25 mm / 77x30 mm  
23-083-170  
75x30 mm / 92x38 mm  
17 cm, 6 3/4"



### KALLMORGEN VAGINAL SPECULUM

23-084-200 70 x 40 mm  
23-085-200 90 x 40 mm  
20 cm, 8"



### KALLMORGEN VAGINAL RETRACTOR

23-086-200 70 x 33 mm  
23-087-200 90 x 33 mm  
20 cm, 8"



### MATHIEU Vaginal Retractor

23-088-210 95 x 16 mm  
23-089-210 95 x 26 mm  
23-090-210 95 x 30 mm  
21 cm, 8 1/2"



### MATHIEU Vaginal Retractor

23-091-220 100 x 11 mm  
23-092-220 100 x 14 mm  
23-093-220 100 x 20 mm  
23-094-220 100 x 26 mm  
22 cm, 8 3/4"



### DOYEN VAGINAL SPECULUM

22 cm, 8 3/4"

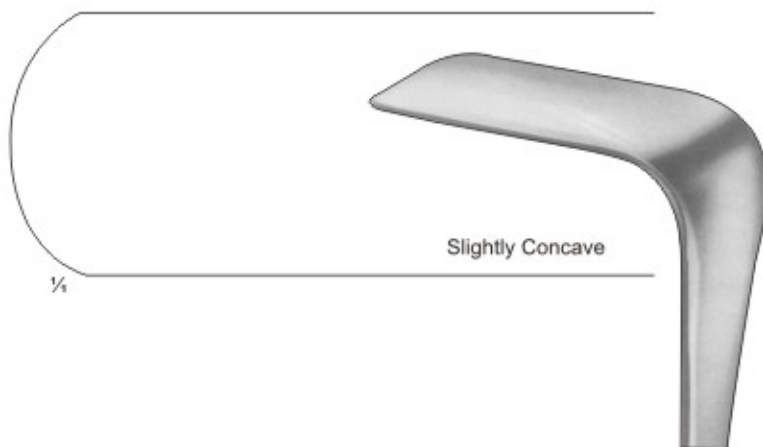

23-095-220 60 x 35 mm  
23-096-220 90 x 35 mm  
23-097-220 120 x 35 mm  
23-098-220 60 x 45 mm  
23-099-220 90 x 45 mm  
23-100-220 120 x 45 mm  
23-101-220 160 x 45 mm  
23-102-220 60 x 60 mm  
23-103-220 90 x 60 mm  
23-104-220 120 x 60 mm  
23-105-220 160 x 60 mm



### LANDON VAGINAL RETRACTOR

23-106-090  
Blade 9 cm  
Deep 2.5 cm wide.

# VAGINAL SPECULA (FOR CHILDREN AND VIRGINS)

Vaginalspekula  
Espéculos vaginales

Spéculums vaginaux  
Specoli vaginali

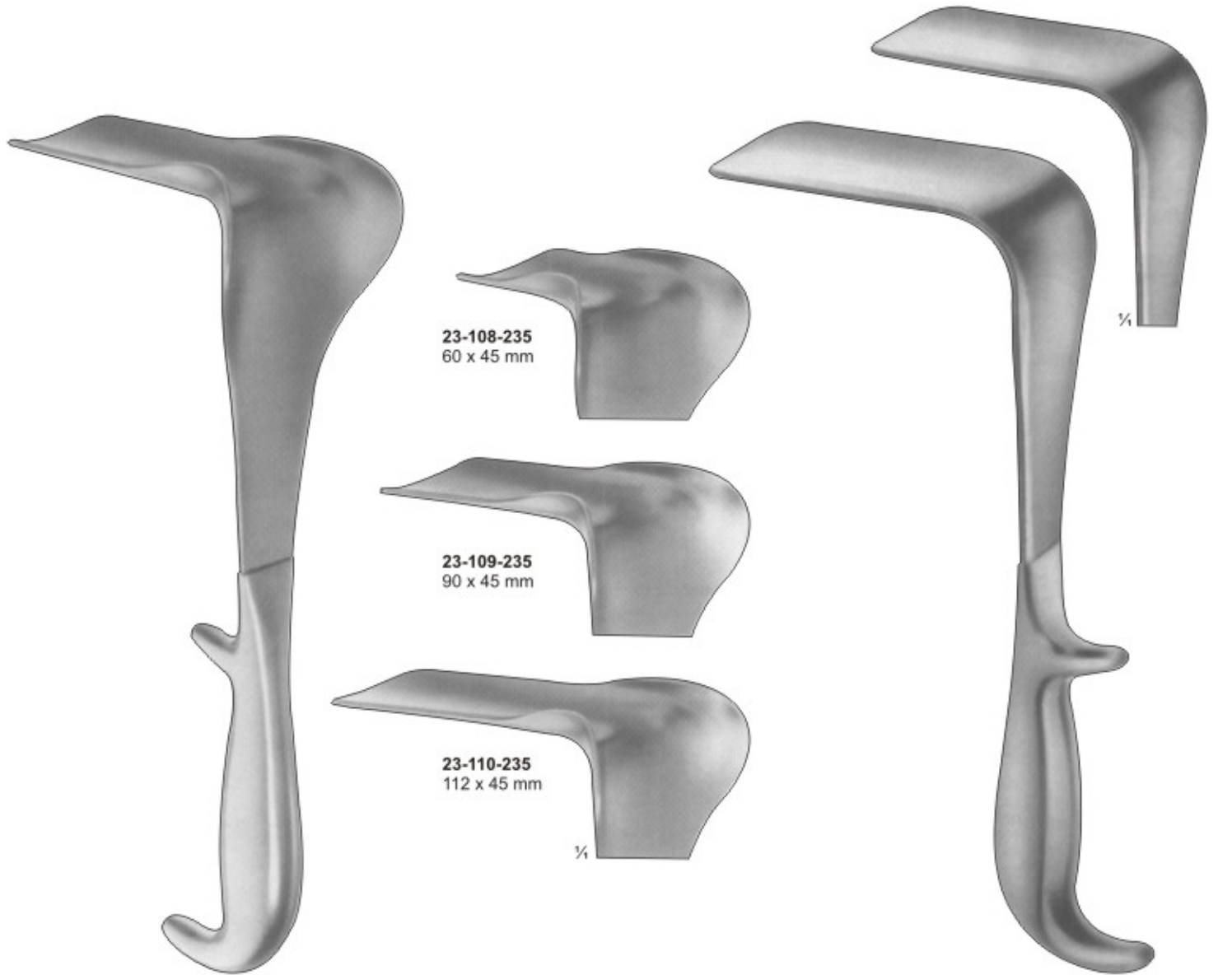

**DOYEN**  
23-107-235  
23.5 cm, 9 1/4"

23-108-235  
60 x 45 mm

23-109-235  
90 x 45 mm

23-110-235  
112 x 45 mm

	Length of blades	Width of blades
23-111-190	60 mm	35 mm
23-112-190	90 mm	45 mm
23-113-190	120 mm	60 mm
23-114-190	160 mm	70 mm

19 cm, 7 1/2"



## VAGINAL SPECULA & RETRACTORS

Vaginalspekula, scheidenhalter  
Especulos vaginales, valvas vaginales

Spéculums vaginaux, valves vaginales  
Specoli vaginali, valve vaginali



**BREISKY  
WIENER MODELL/  
VIENNA PATTERN**

23-115-300 100 x 20 mm  
23-116-300 100 x 25 mm  
23-117-300 100 x 30 mm  
23-118-300 100 x 35 mm  
23-119-300 100 x 40 mm  
30 cm, 12"



**BREISKY  
WIENER MODELL/  
VIENNA PATTERN**

23-120-320 130 x 20 mm  
23-121-320 130 x 25 mm  
23-122-320 130 x 30 mm  
23-123-320 130 x 35 mm  
23-124-320 130 x 40 mm  
32 cm, 12 1/2"



**LANDAU**

23-125-300 105 x 28 mm  
23-126-300 105 x 38 mm  
30 cm, 12"



**WEISSBARTH**

23-127-210 80 x 28 mm  
23-128-210 85 x 42 mm  
21 cm, 8 1/4"



**DOYEN**

Lateral Speculum  
23-129-250 80 x 30 mm  
25 cm, 10"

# VAGINAL SPECULA

Vaginalspekula  
Espéculos vaginales

Spéculums vaginaux  
Specoli vaginali

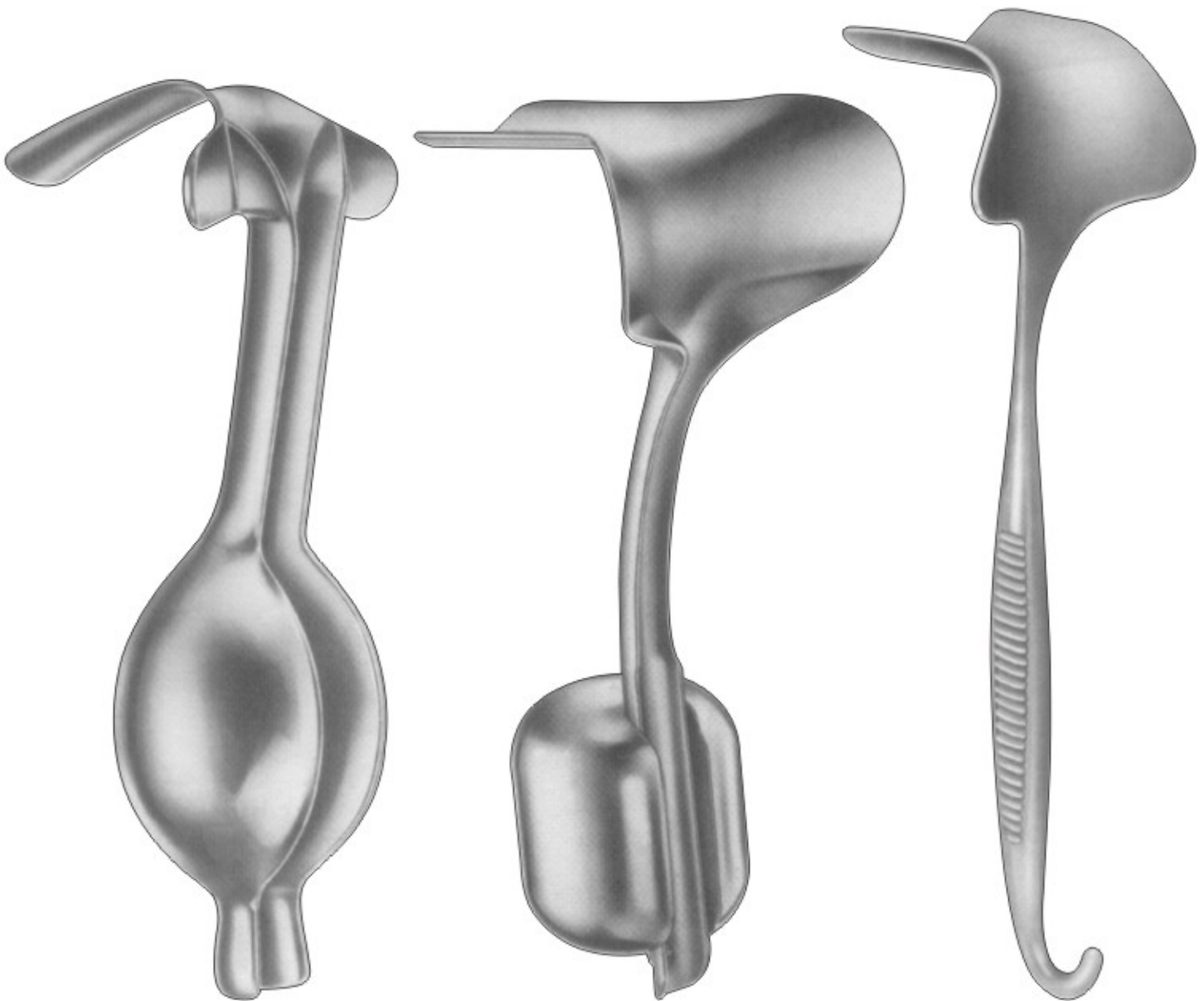

**AUVARD**  
**23-130-230**  
65 x 38 mm - 28 mm  
1,530 kg  
with fixed weight  
23 cm, 9"

**AUVARD**  
**23-131-230** 75 x 42 mm  
(40 mm)  
**23-132-230** 105 x 43 mm  
(40 mm)  
with detachable weight  
23 cm, 9"

**MARTIN**  
**23-133-270**  
with hook shaped  
handle for hanging  
in weights  
27 cm, 10 3/4"



# VAGINAL SPECULA

Vaginalspekula  
Especulos vaginales

Spéculums vaginaux  
Specoli vaginali



**23-134-001**  
80 x 30



**23-135-002**  
85 x 35



**23-136-003**  
85 x 40



**23-137-004**  
55 x 40 - 60 mm



**23-138-005**  
70 x 45 - 70 mm

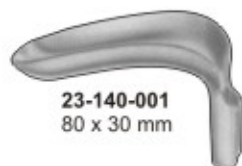

**23-140-001**  
80 x 30 mm



**23-144-005**  
65 x 30 mm



**23-141-002**  
85 x 33 mm



**23-145-006**  
75 x 35 mm

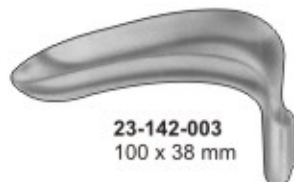

**23-142-003**  
100 x 38 mm



**23-146-007**  
85 x 35 mm



**23-143-004**  
110 x 42 mm



**23-147-008**  
95 x 35 mm

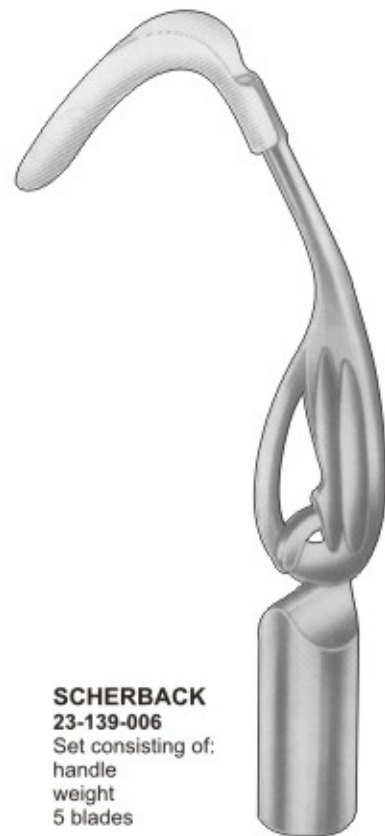

**SCHERBACK**  
**23-139-006**  
Set consisting of:  
handle  
weight  
5 blades

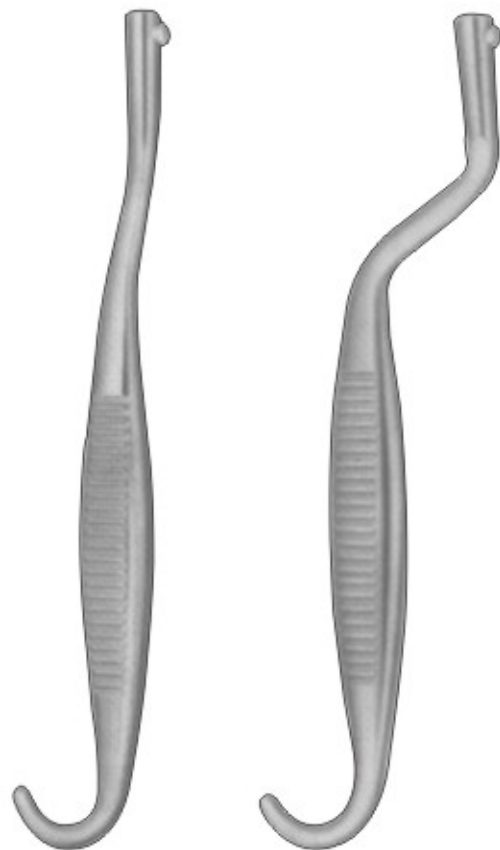

**SCHERBACK**  
**23-148-009**  
Set consisting of:  
2 handle  
8 blades

# UTERIN SOUNDS, VAGINAL SPECULUM T.C. INSERTED

*Uterussonden, Vaginalspekula  
histerómetros, Espéculos vaginales,*

*Hystérometres, Spéculums vaginaux,  
isterometri, Specoli vaginali,*

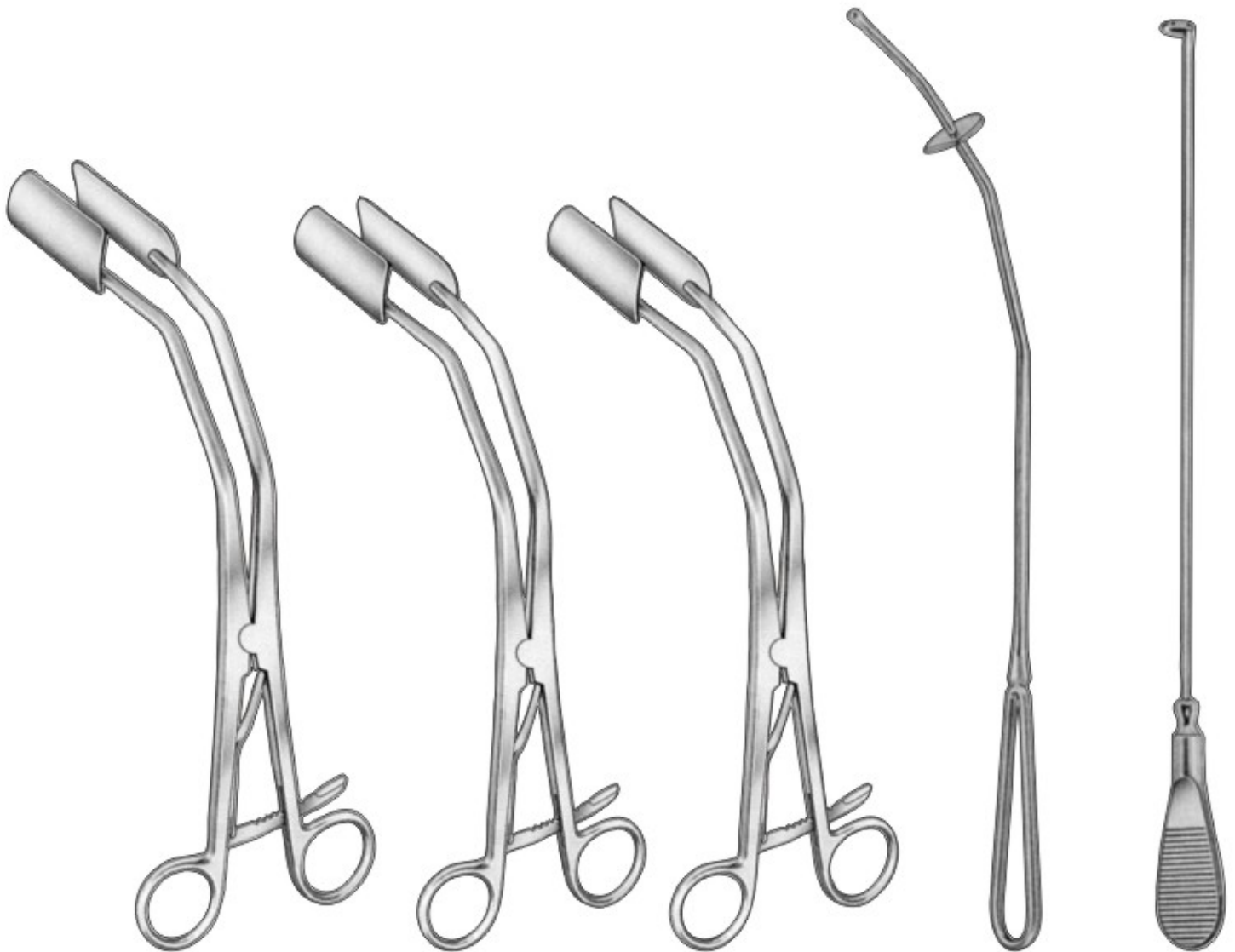

**NEW PORT**  
23-149-250  
25 cm, 10"

**Lateral Vaginal  
Retractor**  
23-150-210  
21 cm 8 1/4"

**Lateral Vaginal Retractor  
Blue Coated Leep / Lietz**  
23-151-210  
21 cm 8 1/4"

**RAMATHIBODI**  
23-152-275  
27.5 cm, 11"  
Uterine Manipulator

**RAMATHIBODI**  
23-153-250  
25 cm, 10"  
Tubal hook





## VAGINAL SPECULUM

Vaginalspekula  
Espéculos vaginales

Spéculums vaginaux  
Specoli vaginali

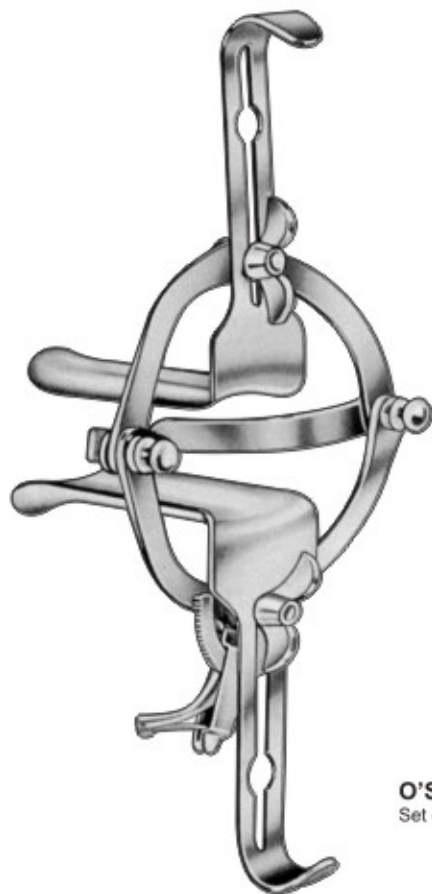

**O'SULLIVAN - O'CONNOR**  
Set of Complete  
23-154-001  
23-155-002  
23-156-003  
23-157-004



23-155-002  
45 x 17 mm



23-156-003  
90 x 37 mm



23-157-004  
90 x 45 mm



**ABDOMINAL RETRACTOR**  
23-158-090 9 cm, 3 1/2" wide  
23-159-100 10 cm, 4" wide  
23-160-115 11.5 cm, 4 1/2" wide



**FRIEDMANN**  
23-161-100  
10 cm, 4"

# UTERINE TENACULUM FORCEPS



Hakenzangen, amniotom  
Pinza para cuello uterino, amniótomo

Pince pour le col de l'utérus, amniotome  
Pinza per il collo dell'utero, amniotomo

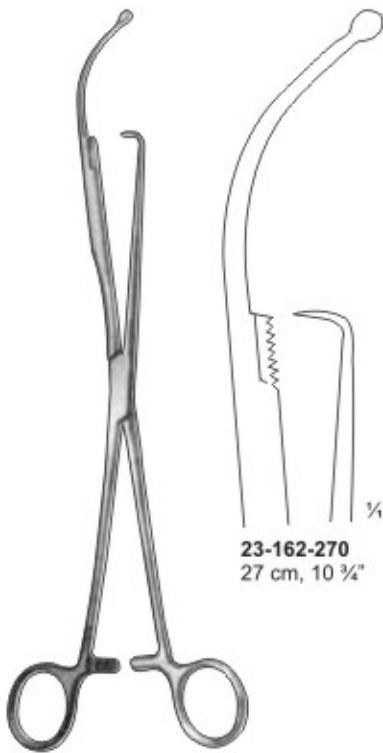

**23-162-270**  
27 cm, 10 1/2"

**HULKA GYNE**



**23-163-240**  
24 cm, 9 1/2"  
With ratchet  
3 mm

**KOGAN GYNE**

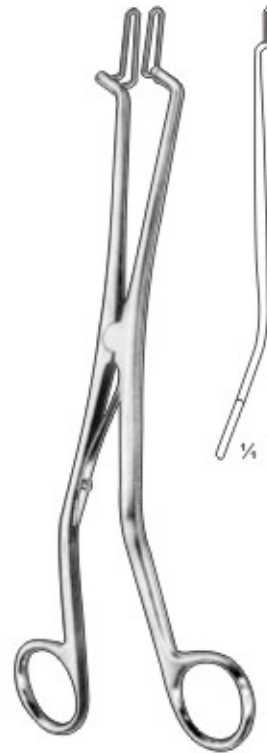

**KOGAN**  
**23-164-240**  
24 cm, 9 1/2"



**KOGAN**  
**23-165-240**  
24 cm, 9 1/2"

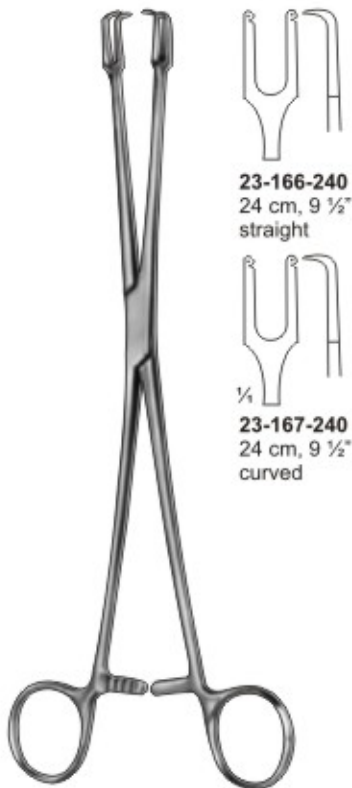

**23-166-240**  
24 cm, 9 1/2"  
straight

**23-167-240**  
24 cm, 9 1/2"  
curved

**SCHRÖDER GYNE**

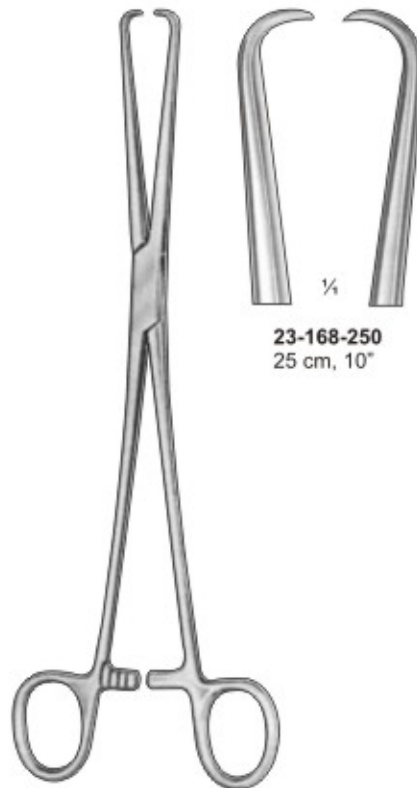

**23-168-250**  
25 cm, 10"

**SCHRÖDER**

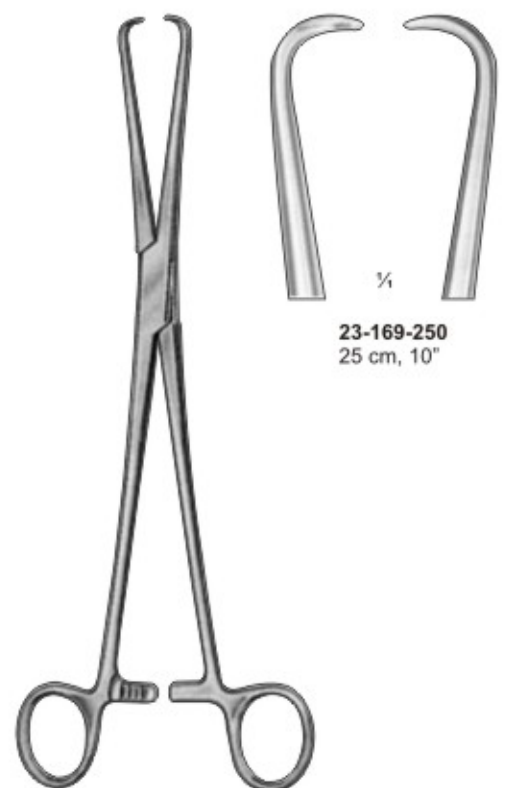

**23-169-250**  
25 cm, 10"

**POZZI GYNE**



## UTERINE TENACULUM & UTERINE POLYPUS FORCEPS

Hakenzangen, Uterus-Polypen zangen

Pince pour le col de l'utérus, pinces a ploypes utérins

Pinza para cuello uterino, Pinzas para polipos uterinos Pinza per il collo dell'utero, Pinze per polipi uterini



**BARRETT**  
23-170-180  
18 cm, 7"

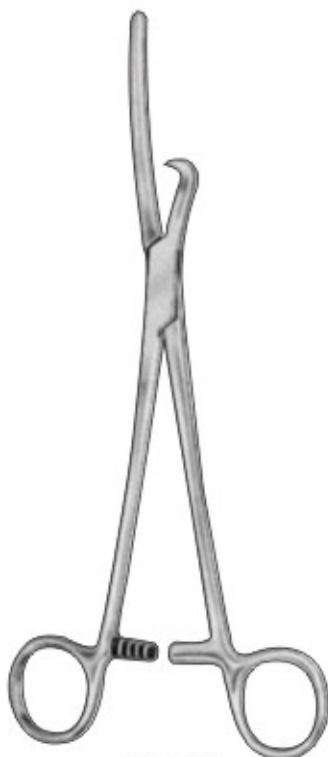

**SAIRGES**  
23-171-230  
23 cm, 9"



**MUSEUX**  
24 cm, 9 1/2"



23-172-240  
6 mm



23-173-240  
8 mm



23-174-240  
10 mm



**MUSEUX**  
24 cm, 9 1/2"



23-175-240  
6 mm



23-176-240  
8 mm



23-177-240  
10 mm

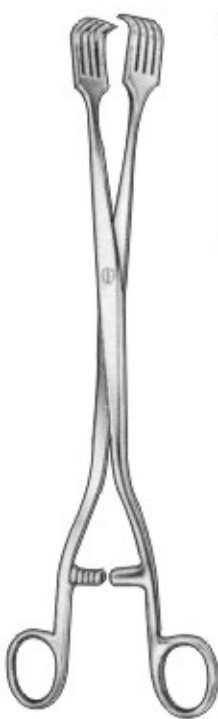

**PRATT**  
23-178-280  
28 cm, 11"

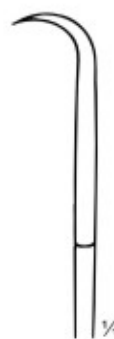
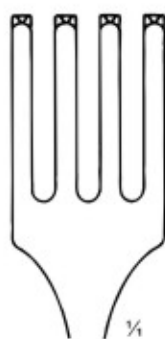

**TEALE**  
23-179-230  
23 cm, 9"



# MYOMA SCREWS, MYOMA KNIFE, UTERINE SEIZING FORCEPS



Myomheber, Myommesser, Uterusfasszange

Tracteurs pour fibromes, evideur de fibromes, Pinces hystérolabes

Tirabuzones para fibroma, cuchillo para fibroma, Histerólabos

Tiramiomi, bisturi per fibromi, Pinze isterolabi



**JACOBS**  
23-180-210  
21 cm, 8 1/4"  
Straight



**IOWA**  
23-181-260  
26 cm, 10 1/4"



**DARTIGUES**  
23-182-270  
27 cm, 10 1/2"

For polypus forceps see Section 6.



**DOYEN**  
23-183-170  
17 cm, 6 3/4"



**DOYEN**  
23-184-140  
14 cm, 5 1/2"

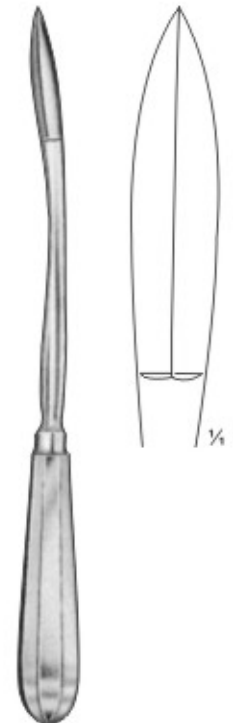

**SEGOND**  
23-185-270  
27 cm, 10 1/2"



# UTERINE SCOOPS, SUCTION CURETTES & UTERINE DEPRESSOR

Uteruslöffel, Absaugküretten, uterusdepressor  
Cucharillas uterinas, Curetas aspiradoras, depresor uterino

Curettes uterines, curettes d'aspiration, Dépresseur utérin  
Curette uterine, curette pe aspirazione, depressore uterino



**BRAUN**  
23-186-280  
28 cm, 11"

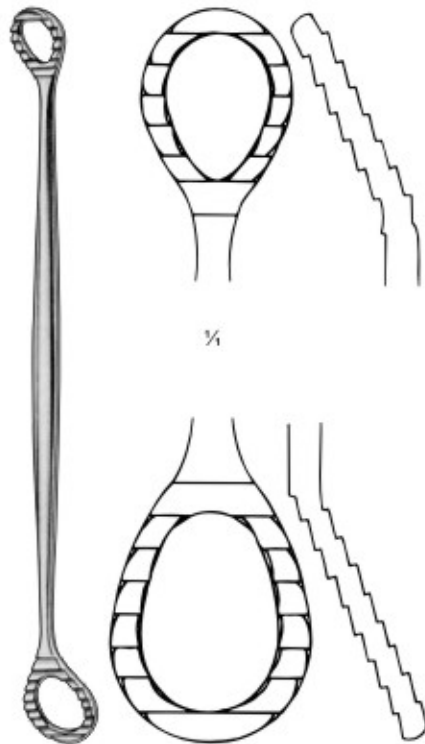

**SIMS**  
23-187-260  
26 cm, 10 1/4"

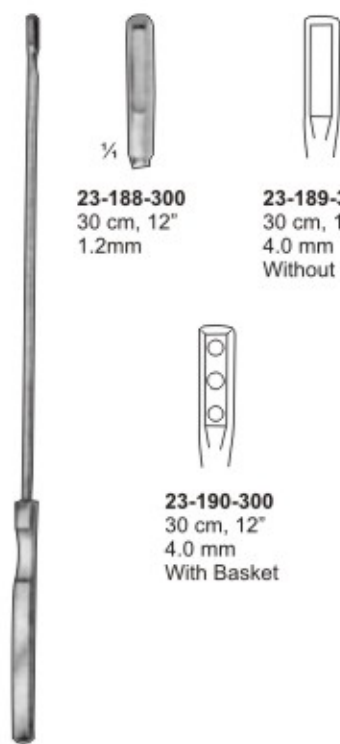

23-188-300  
30 cm, 12"  
1.2mm

23-189-300  
30 cm, 12"  
4.0 mm  
Without Basket

23-190-300  
30 cm, 12"  
4.0 mm  
With Basket

**KEVORKIAN**



**BLAKE**  
23-191-270  
27 cm, 10 3/4"



**SCHROEDER**  
30 cm, 12"  
sharp, rigid



23-192-001



23-193-002

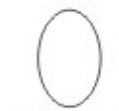

23-194-003

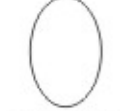

23-195-004



23-196-005



23-197-006

# UTERINE SCOOPS, SUCTION CURETTES & UTERINE DEPRESSOR



Uteruslöffel, Absaugküretten, uterusdepressor

Curettes uterines, curettes d'aspiration, Dépresseur utérin

Cucharillas uterinas, Curetas aspiradoras, depresor uterino

Curette uterine, curette pe aspirazione, depressore uterino



**SIMON/  
SCHRODER**



Fig. 1  
23-198-250 25 cm, 10"  
23-199-300 30 cm, 12"

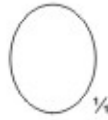

Fig. 3  
23-202-250 25 cm, 10"  
23-203-300 30 cm, 12"

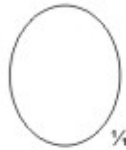

Fig. 5  
23-206-250 25 cm, 10"  
23-207-300 30 cm, 12"



Fig. 2  
23-200-250 25 cm, 10"  
23-201-300 30 cm, 12"

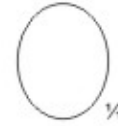

Fig. 4  
23-204-250 25 cm, 10"  
23-205-300 30 cm, 12"

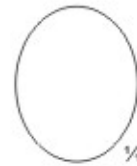

Fig. 6  
23-208-250 25 cm, 10"  
23-209-300 30 cm, 12"



**COLLIN**  
28 cm, 11"



23-210-280  
8.0 mm



23-211-280  
10.0 mm



23-212-280  
12.0 mm



23-213-280  
14.0 mm



**GOURDET**  
28 cm, 11"



Fig. 1  
23-214-280



Fig. 2  
23-215-280



Fig. 3  
23-216-280



Fig. 4  
23-217-280



Fig. 5  
23-218-280



# UTERINE CURETTES

Uterusküretten  
Curetas uterinas

Curettes utérines  
curette uterine



## RECAMIER UTERINE CURETTE

23-219-260 26 cm 10 1/4"  
23-220-310 31cm, 12 1/4"  
Sharp/Blunt

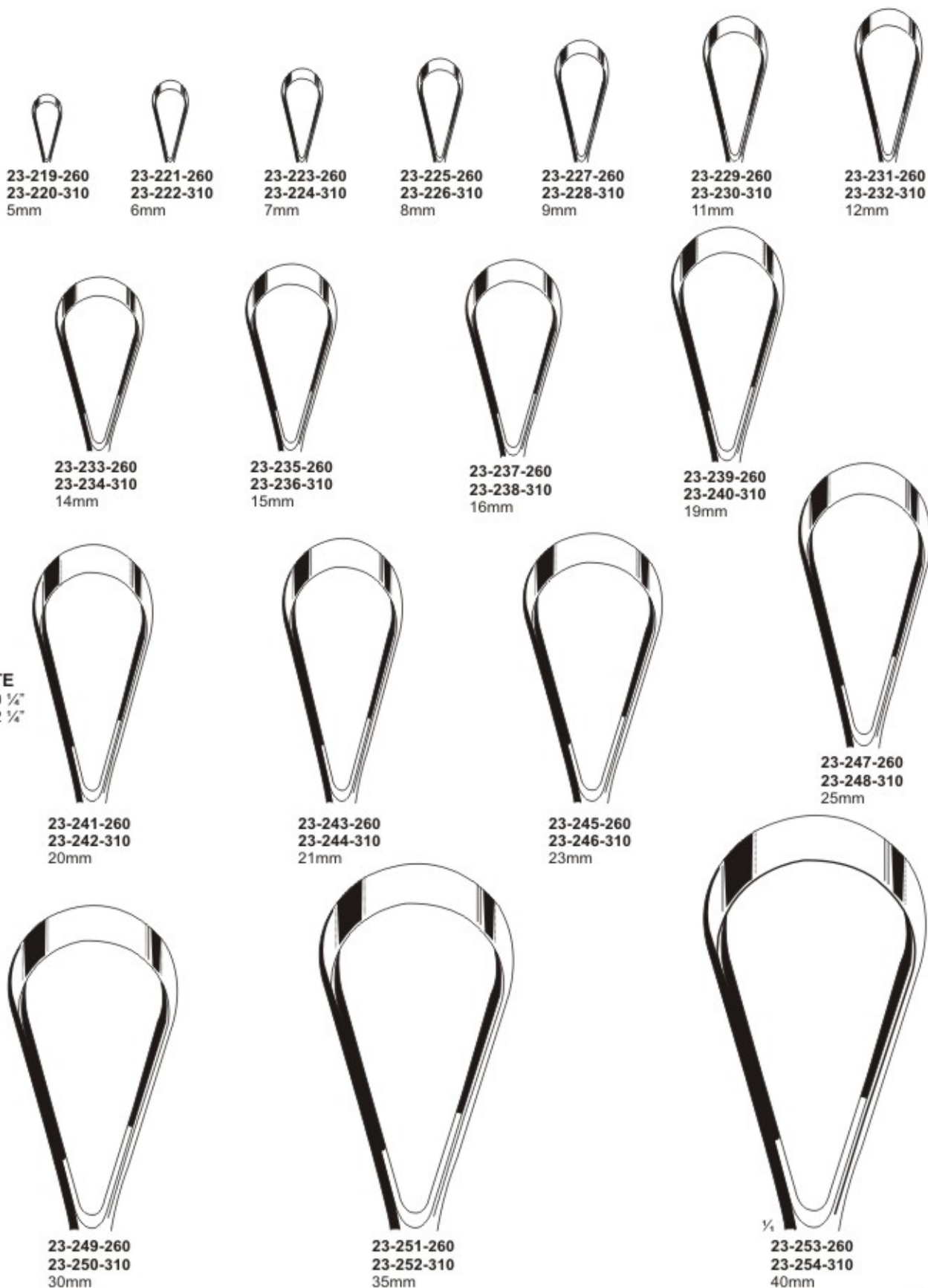

# UTERINE CURETTES



Uterusküretten  
Curetas uterinas

Curettes utérines  
curette uterine



Recamier  
Uterine Curette  
23-255-260  
26 cm, 10 1/4"  
23-256-310  
31cm, 12 1/2"  
Sharp/Blunt

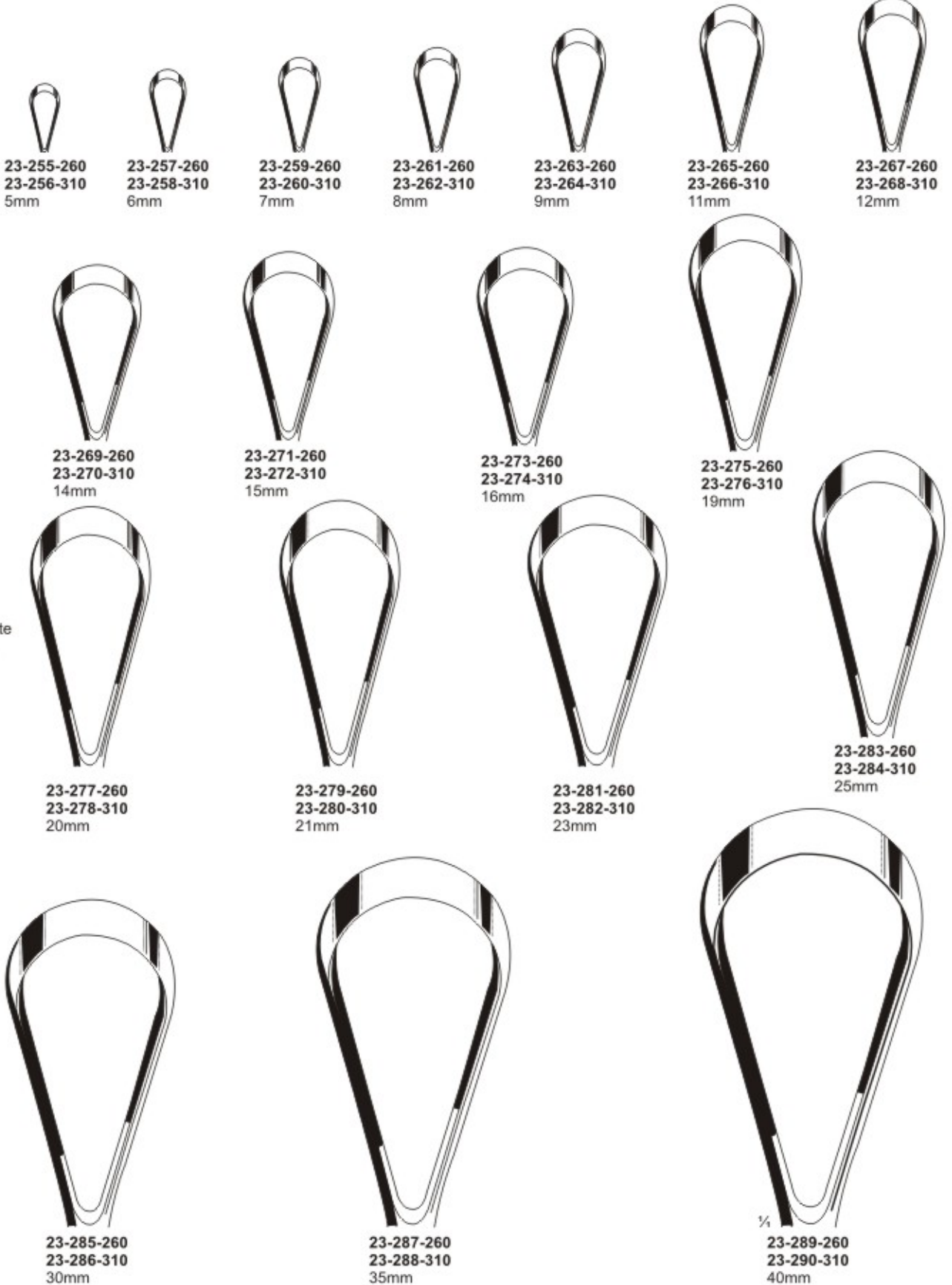





# UTERINE CURETTES

Uterusküretten  
Curetas uterinas

Curettes utérines  
curette uterine



Sims  
Uterine Curette  
23-291-260  
26 cm, 10 1/4"  
23-292-310  
31cm, 12 1/2"  
Sharp/Blunt



23-293-260  
23-294-310  
5mm



23-295-260  
23-296-310  
6mm



23-297-260  
23-298-310  
7mm



23-299-260  
23-300-310  
8mm



23-301-260  
23-302-310  
9mm



23-303-260  
23-304-310  
11mm



23-305-260  
23-306-310  
12mm



23-307-260  
23-308-310  
14mm



23-309-260  
23-310-310  
15mm



23-311-260  
23-312-310  
16mm



23-313-260  
23-314-310  
19mm



23-315-260  
23-316-310  
20mm



23-317-260  
23-318-310  
21mm



23-319-260  
23-320-310  
23mm



23-321-260  
23-322-310  
25mm



23-323-260  
23-324-310  
30mm



23-325-260  
23-326-310  
35mm



23-327-260  
23-328-310  
40mm

# UTERINE CURETTES



Uterusküretten  
Curetas uterinas

Curettes utérines  
curette uterine



Sims  
Uterine Curette  
23-329-260  
26 cm, 10 1/4"  
23-330-310  
31 cm, 12 1/2"  
Sharp/Blunt

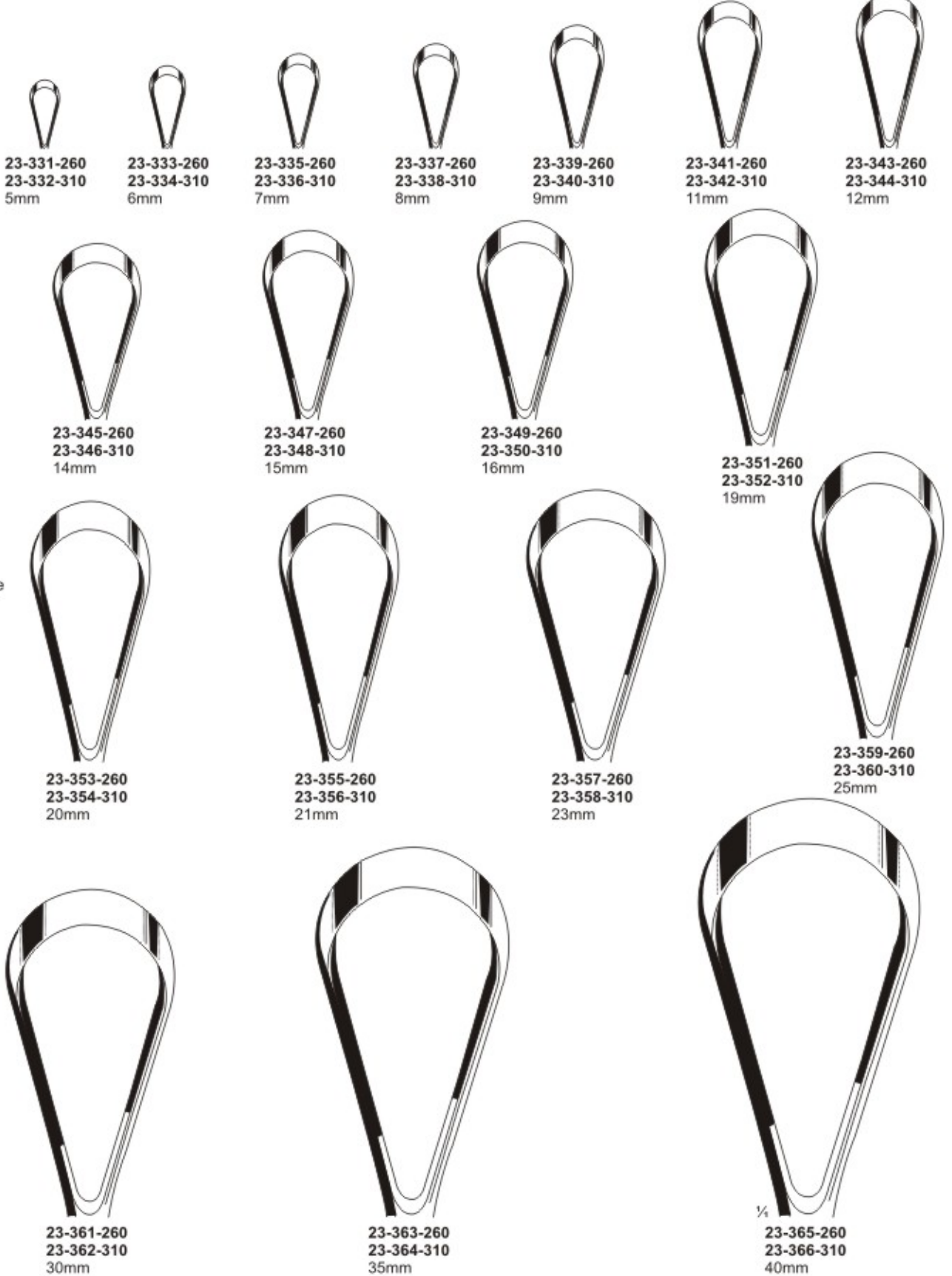



# UTERINE SOUNDS

Uterussonden  
Histerómetros

Hystéromètres  
Isterometri

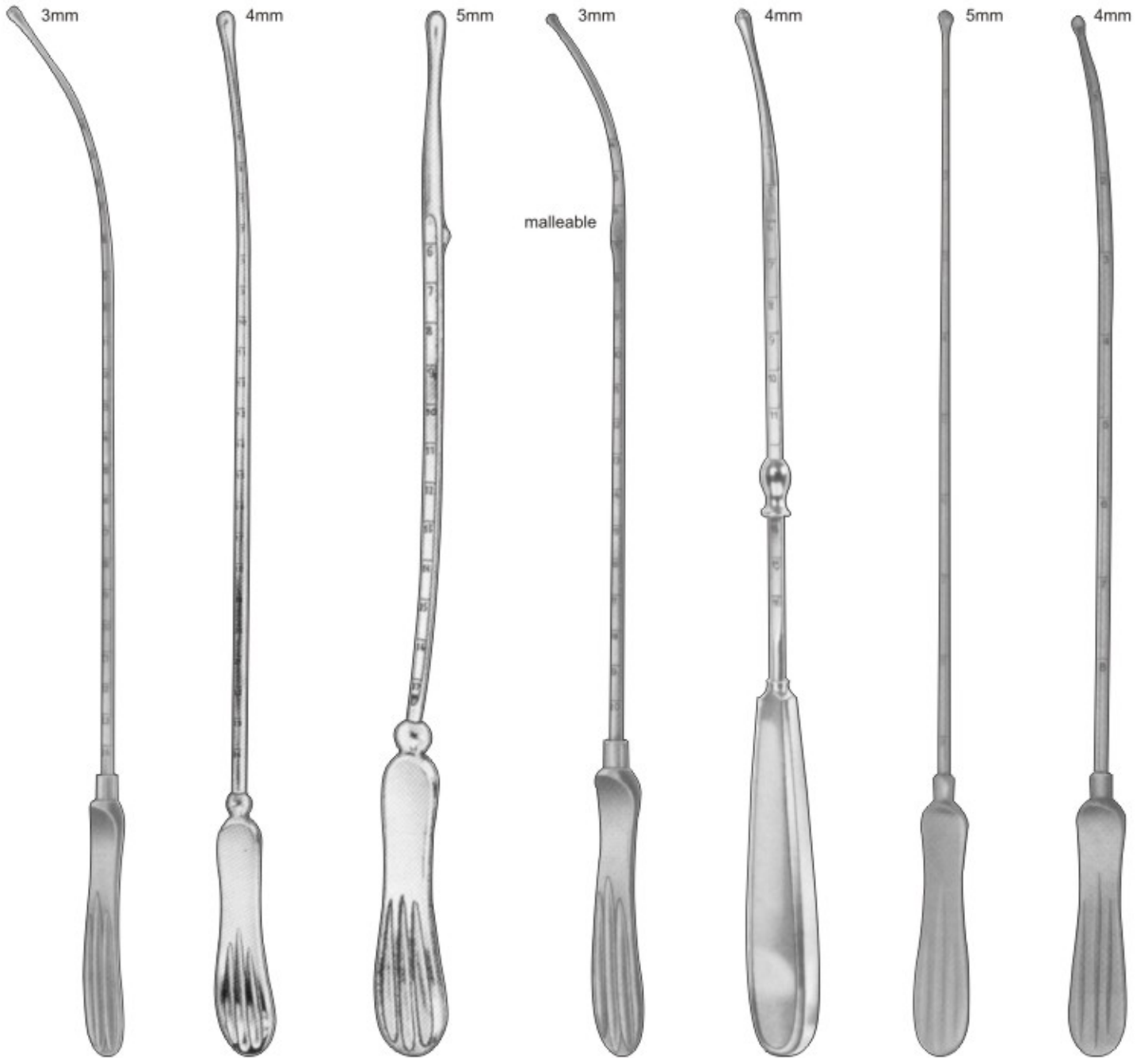

**SIMS**  
23-367-320  
32 cm, 13"  
right  
malleable

**SIMS-SPECIAL**  
23-368-320  
32 cm, 13"

**SIMS**  
schwed. Modell  
23-369-260  
26 cm, 10 1/4"

**MARTIN**  
23-370-300  
30 cm, 12"

**VALLEIX**  
23-371-250  
25 cm, 10"

**MAYO**  
23-372-330  
biegsam  
malleable  
33 cm

**SIMPSON**  
23-373-290  
malleable  
silver-plated  
29 cm

# UTERINE SOUNDS

Uterussonden  
Histerómetros

Hystéromètres  
Isterometri

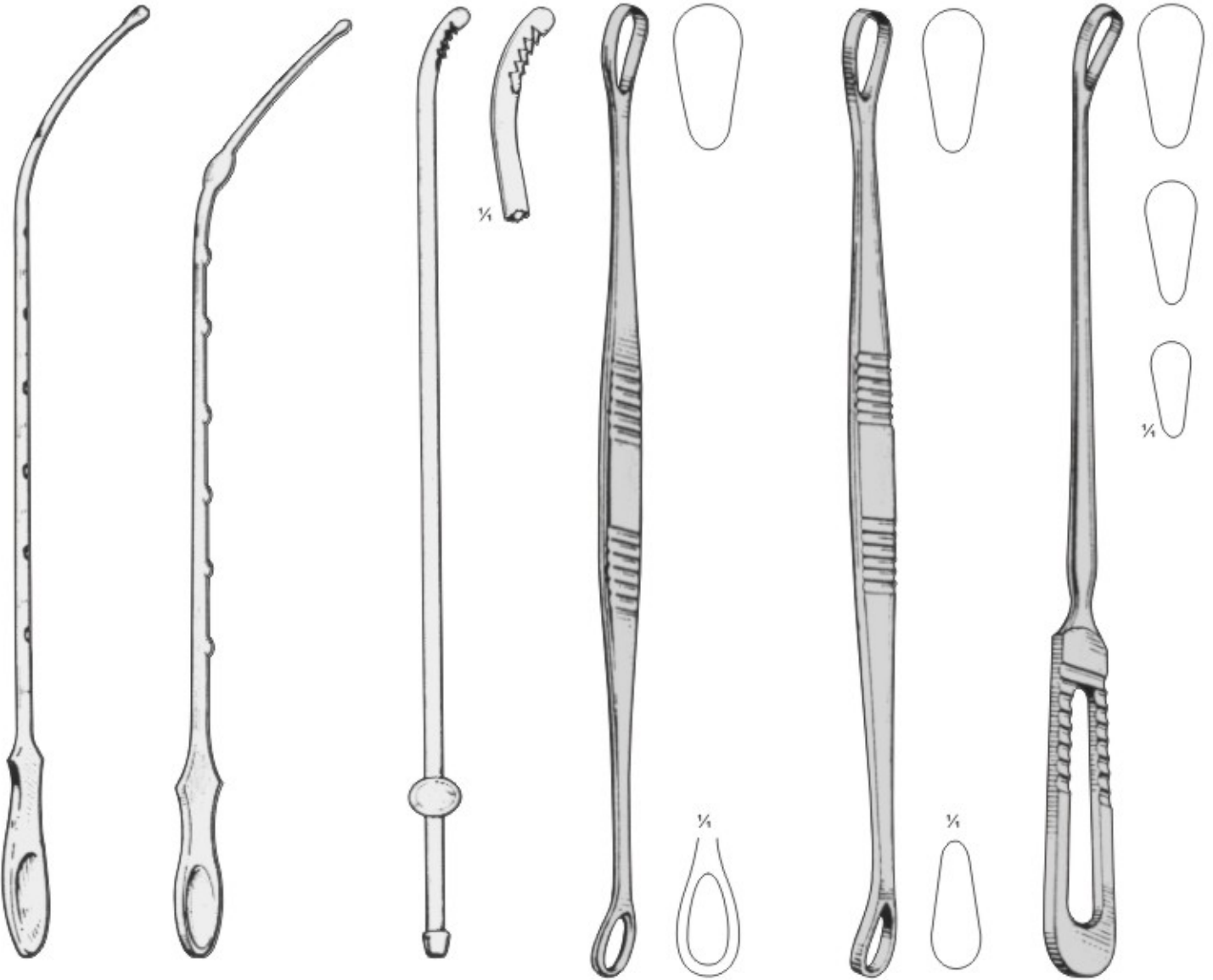

**GALABIN**  
23-374-320  
malleable, shaft  
graduated in cm  
Silver plated,  
32 cm, 12 1/4"

**HORROCKS  
UTERINE  
SOUND**  
23-375-320  
malleable, shaft  
graduated in cm  
Silver plated,  
32 cm, 12 1/4"

**NOVAK "SUCTION  
CANNULA  
CURETTE"**  
23-376-254  
Luer cone,  
25.4 cm, 10"

**SIMS UTERINE  
CURETTE**  
23-377-250  
double ended, sharp  
as above but blunt  
25 cm, 10"  
small, medium, large

**SIMS UTERINE  
CURETTE.**  
23-378-250  
double ended, sharp  
25 cm, 10"  
long.

**SIMS UTERINE  
CURETTE**  
23-379-250  
single ended, sharp  
and blunt ends.  
25 cm, 10"  
long.



## VACUUM CURETTES

### 23-380-250

suction currettes, stainless steel, fitting hose connection.

Working tips are smoothly rounded of, therefore no danger of perforation.



(Suitable for suction biopsy)

**23-380-250:** diam 4 mm  
**23-381-250:** diam 6 mm  
**23-382-250:** diam 8 mm  
**23-383-250:** diam 10 mm  
**23-384-250:** diam 12 mm  
**23-385-250:** diam 14 mm

### 23-386-250

Hose connection inside diam. 11 mm curved stainless steel.

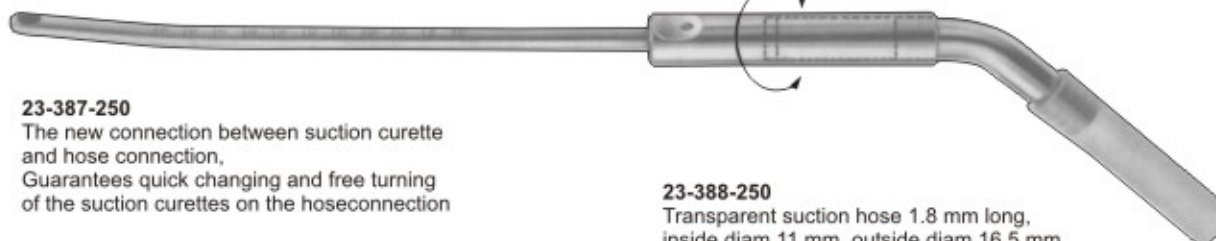

### 23-387-250

The new connection between suction currette and hose connection, Guarantees quick changing and free turning of the suction currettes on the hoseconnection

### 23-388-250

Transparent suction hose 1.8 m long, inside diam 11 mm, outside diam 16.5 mm can be sterilized in an autoclave at 1 bar overpressure (120 C)



### 23-389-250

Strainer for tissue, plastic for single use only, to be used for histopathological examination.

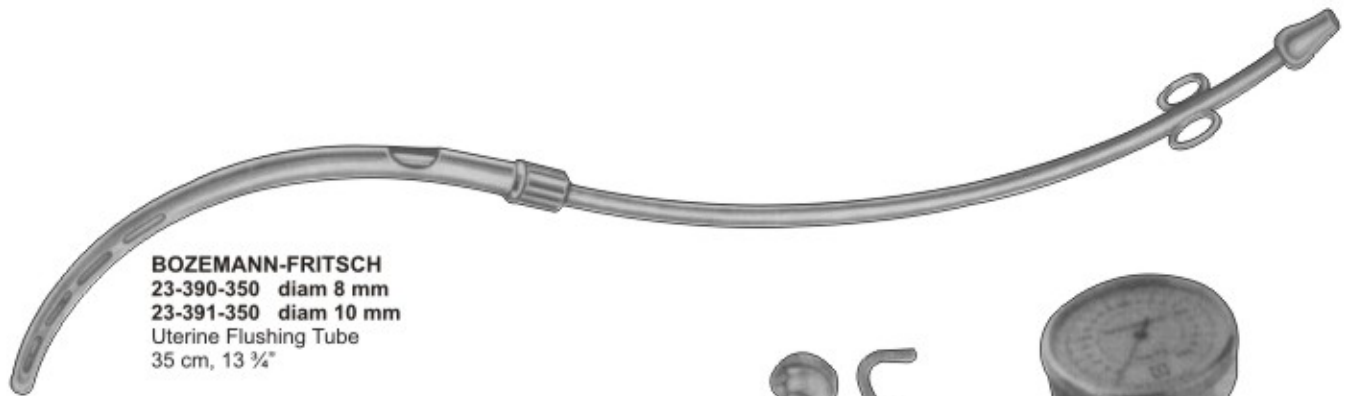

**BOZEMANN-FRITSCH**  
 23-390-350 diam 8 mm  
 23-391-350 diam 10 mm  
 Uterine Flushing Tube  
 35 cm, 13 3/4"

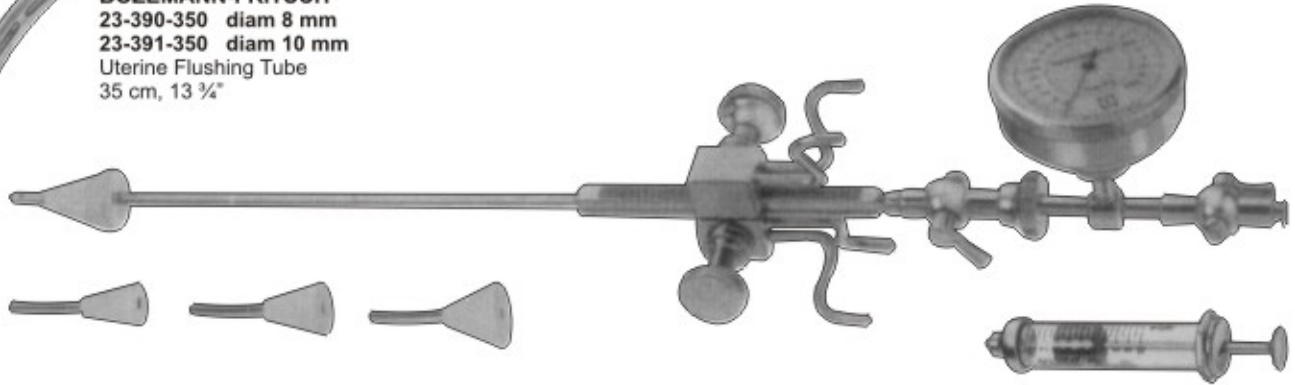

**SCHULZE**  
 23-392-350  
 Salpingograph, for utero-salpingography  
 in wooden case, consisting of:  
 Manometer, Connection, Uterine canulla  
 with tap, cone S.M.L.,  
 record syringe 10 cc, Luer lock mount.

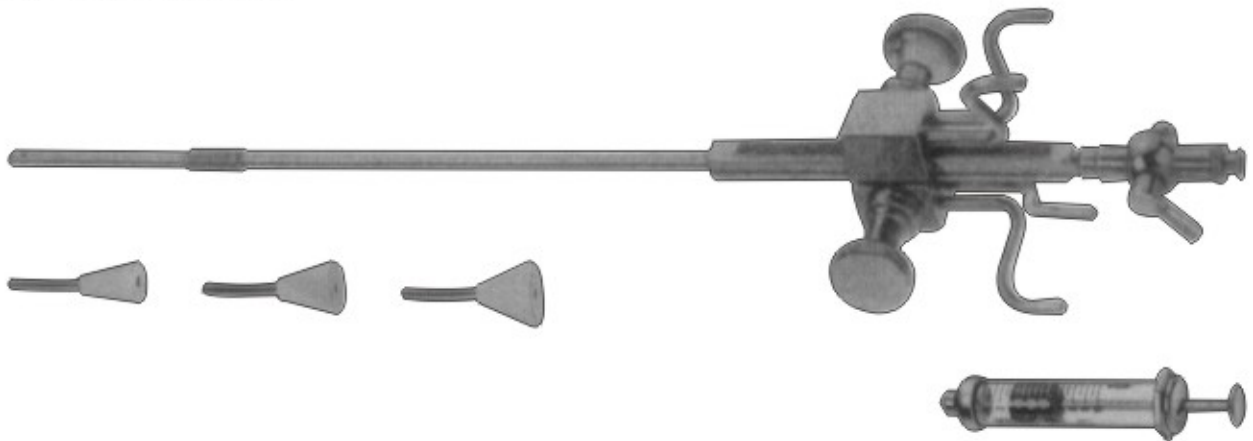

**SCHULZE**  
 23-393-350  
 Salpingograph, equipment  
 without manometer.



## UTERINE DILATORS

Uterusdilatatoren  
Dilatadores uterinos

Dilatateurs du col de l'utérus  
Dilatatori uterini



PRATT GYNE



### PRATT GYNE

23-394-001

Set of 8 Double ended  
size 13/14 thru 41/43  
4.5/5.0mm thru 13.6/14.3mm

23-395-001	04.5/05.0 mm
23-396-002	05.6/06.3 mm
23-397-003	07.0/07.6 mm
23-398-004	08.3/09.0 mm
23-399-005	09.6/10.3 mm
23-400-006	11.0/11.6 mm
23-401-007	12.3/13.0 mm
23-402-008	13.6/14.3 mm



### HEGAR

23-403-001

Set of 8 dilator  
3/4 mm - 17/18 mm  
23-404-002  
Set of 13 dilator  
1/2 mm - 25/26 mm



HANK

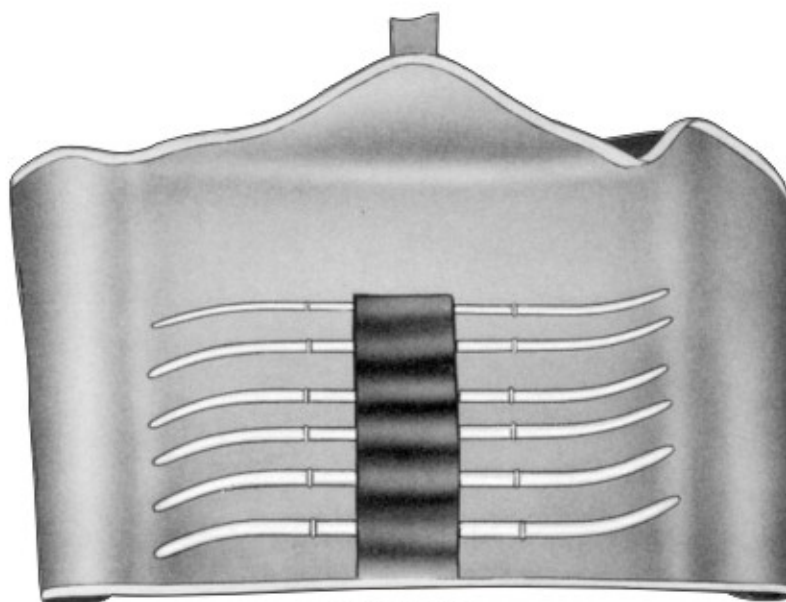

### HANK GYNE

23-411-001

Set of 6 dilators  
4.5/5.0 mm - 9.5/10.0 mm

23-405-001	4.5/5 mm
23-406-002	5.5/6 mm
23-407-003	6.5/7 mm
23-408-004	7.5/8 mm
23-409-005	8.5/9 mm
23-410-006	9.5/10 mm

# UTERINE DILATORS



Uterusdilatoren  
Dilatadores uterinos

Dilatateurs du col de l'utérus  
Dilatatori uterini



**23-412-001**  
Set of 13 dilators  
1/2 mm - 25/26 mm  
**23-413-002**  
Set of 8 dilators  
3/4 mm - 17/18 mm

## HEGAR GYNE



**23-427-001** 1 mm  
**23-428-002** 2 mm  
**23-429-003** 3 mm  
**23-430-004** 4 mm  
**23-431-005** 5 mm  
**23-432-006** 6 mm  
**23-433-007** 7 mm  
**23-434-008** 8 mm  
**23-435-009** 9 mm  
**23-436-010** 10 mm  
**23-437-011** 11 mm  
**23-438-012** 12 mm  
**23-439-013** 13 mm  
**23-440-014** 14 mm  
**23-441-015** 15 mm  
**23-442-016** 16 mm  
**23-443-017** 17 mm  
**23-444-018** 18 mm  
**23-445-019** 19 mm  
**23-446-020** 20 mm  
**23-447-021** 21 mm  
**23-448-022** 22 mm  
**23-449-023** 23 mm  
**23-450-024** 24 mm  
**23-451-025** 25 mm  
**23-452-026** 26 mm  
**23-453-027** 27 mm  
**23-454-028** 28 mm  
**23-455-029** 29 mm  
**23-456-030** 30 mm

## HEGAR GYNE

**23-426-001**  
Set of 26 dilators  
1 mm - 26 mm

**23-412-001** 01/02 mm  
**23-413-002** 03/04 mm  
**23-414-003** 05/06 mm  
**23-415-004** 07/08 mm  
**23-416-005** 09/10 mm  
**23-417-006** 11/12 mm  
**23-418-007** 13/14 mm  
**23-419-008** 15/16 mm  
**23-420-009** 17/18 mm  
**23-421-010** 19/20 mm  
**23-422-011** 21/22 mm  
**23-423-012** 23/24 mm  
**23-424-013** 25/26 mm

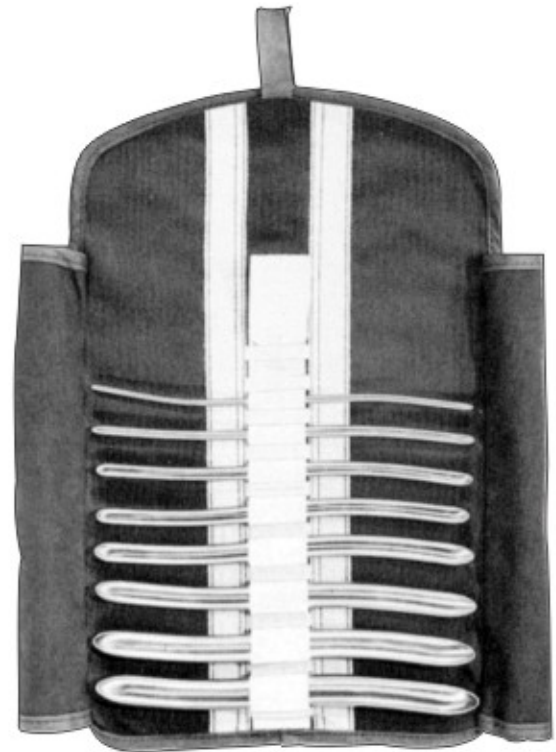

## HEGAR GYNE 23-425-001 Set of 8 dilators 3/4 mm - 17/18 mm



## HEGAR GYNE 23-477-001 Set of 14 dilators 4 mm - 17 mm





## UTERINE BIOPSY FORCEPS

Probeexzisionszangen  
Pinzas para biopsia

Pinces pour biopsi  
Pinze per biopsia

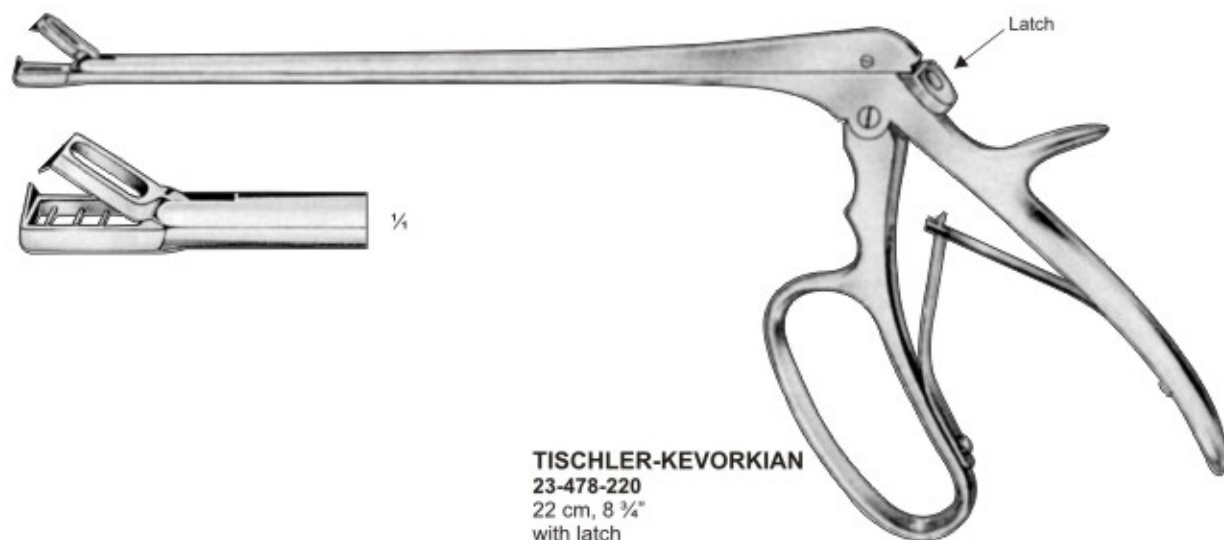

**TISCHLER-KEVORKIAN**  
23-478-220  
22 cm, 8 3/4"  
with latch  
3 x 9.5 mm

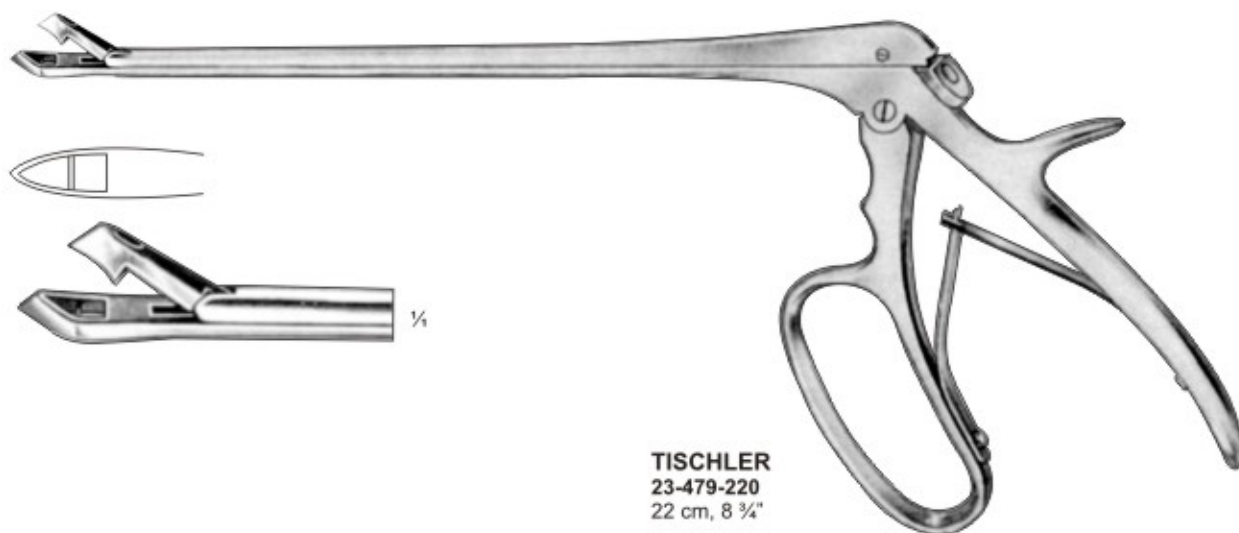

**TISCHLER**  
23-479-220  
22 cm, 8 3/4"

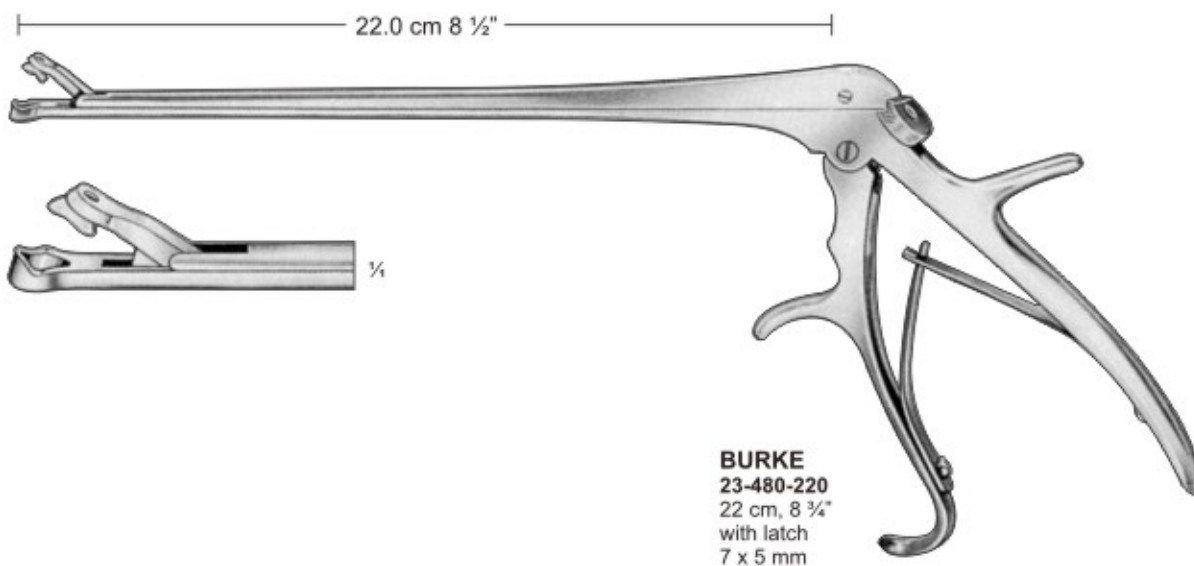

**BURKE**  
23-480-220  
22 cm, 8 3/4"  
with latch  
7 x 5 mm

# UTERINE BIOPSY FORCEPS

Probeexzisionszangen  
Pinzas para biopsia

Pinces pour biopsi  
Pinze per biopsia

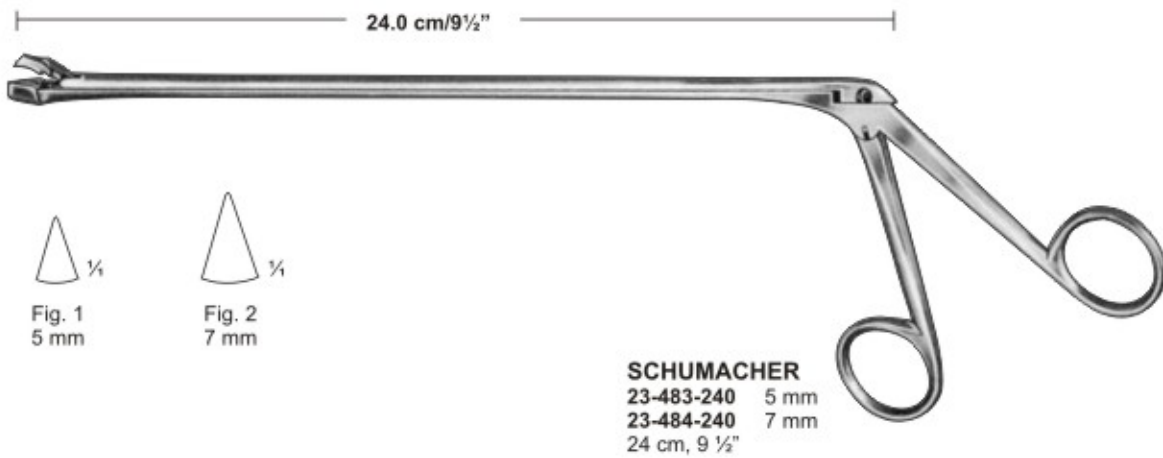
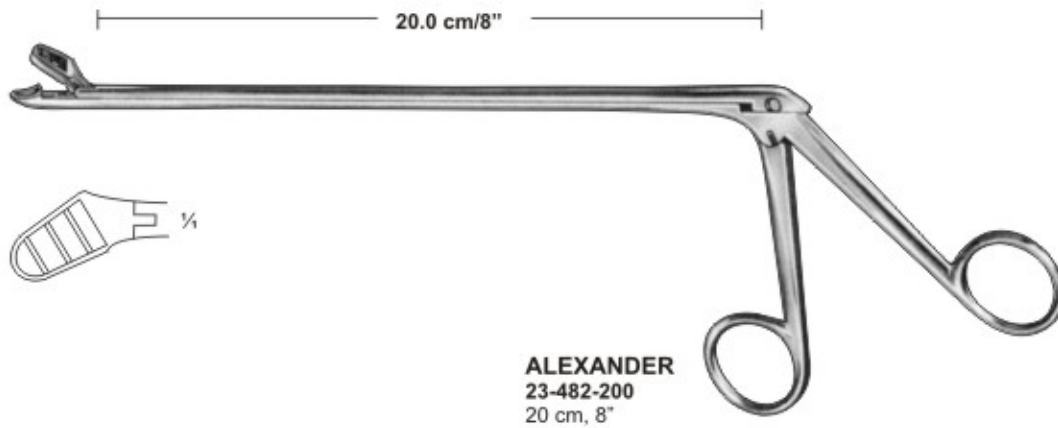
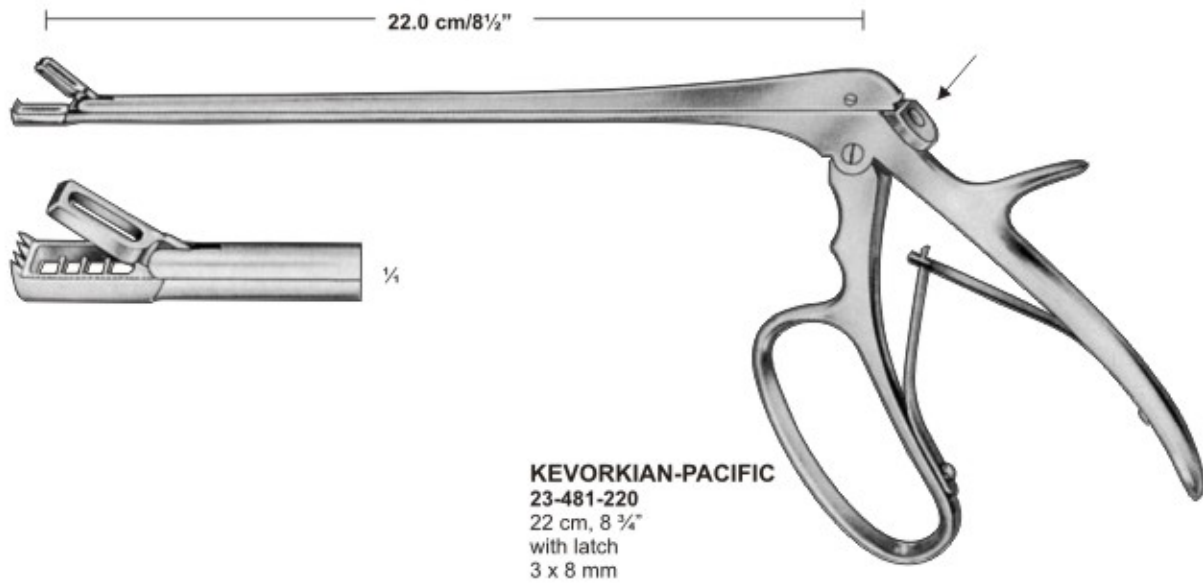



## UTERINE BIOPSY FORCEPS

Probeexzisionszangen  
Pinzas para biopsia

Pinces pour biopsi  
Pinze per biopsia

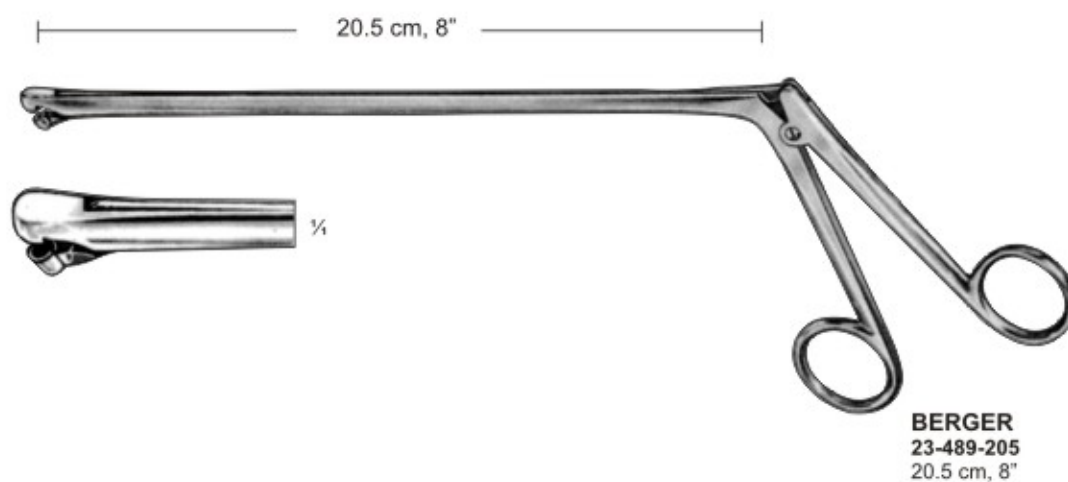
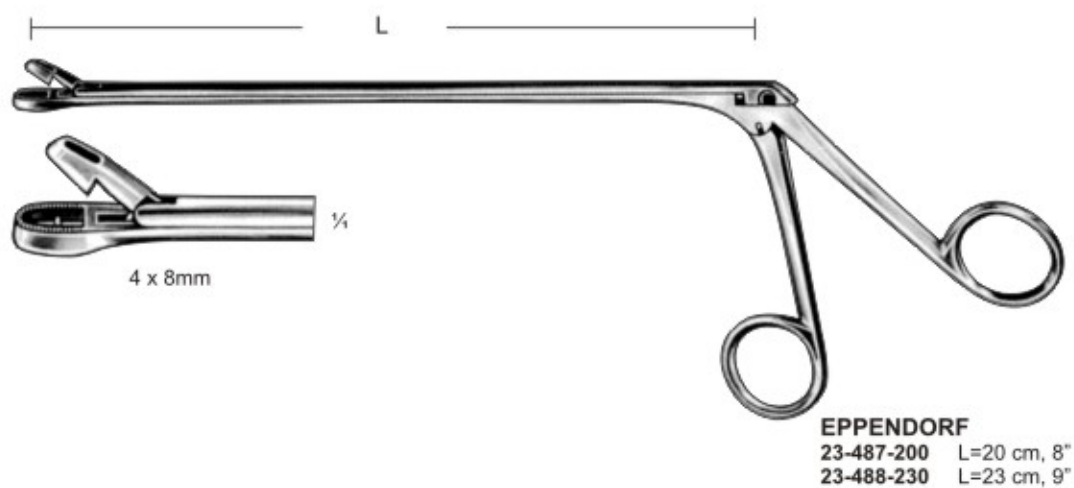
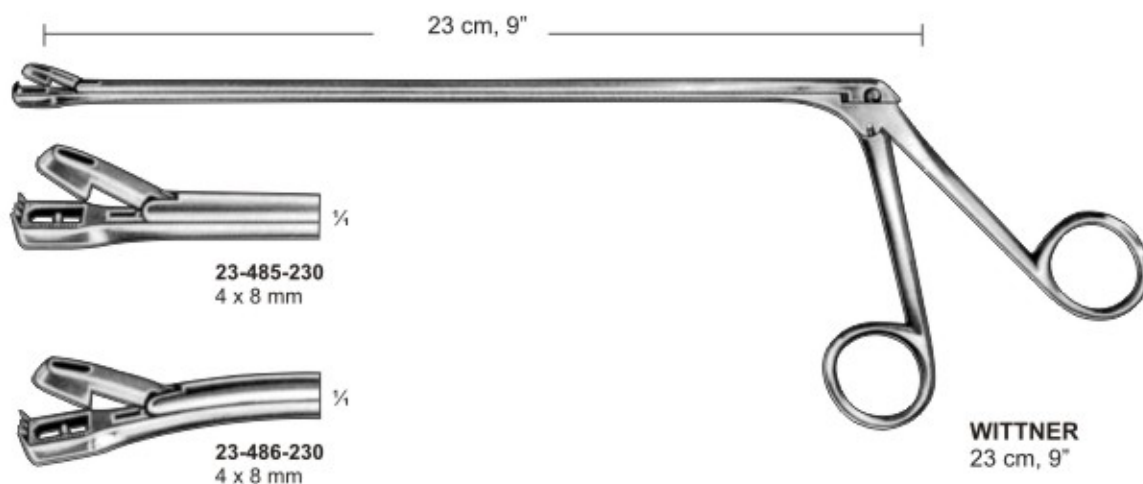

# UTERINE BIOPSY FORCEPS



Probeexzisionszangen  
Pinzas para biopsia

Pinces pour biopsi  
Pinze per biopsia

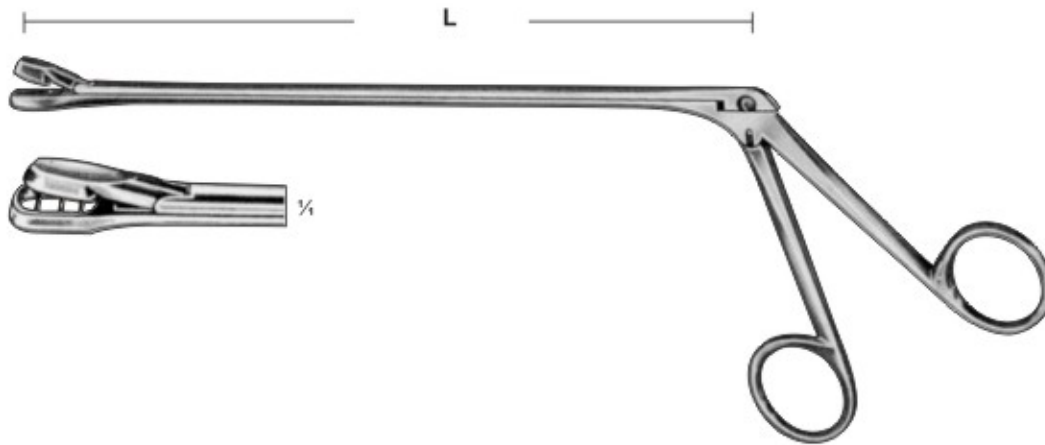

## DOUAY

23-490-200	L=20 cm, 8"
23-491-250	L=25 cm, 10"
23-492-300	L=30 cm, 12"
23-493-350	L=35 cm, 14"
23-494-400	L=40 cm, 16"

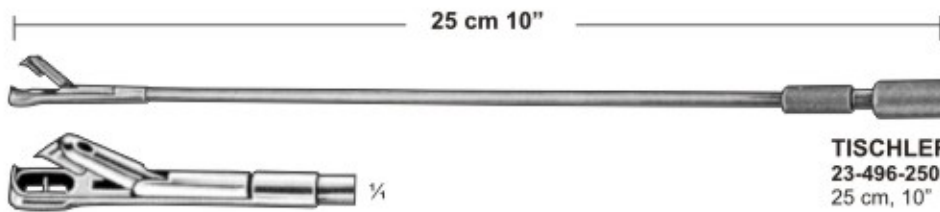

**TISCHLER**  
23-496-250  
25 cm, 10"

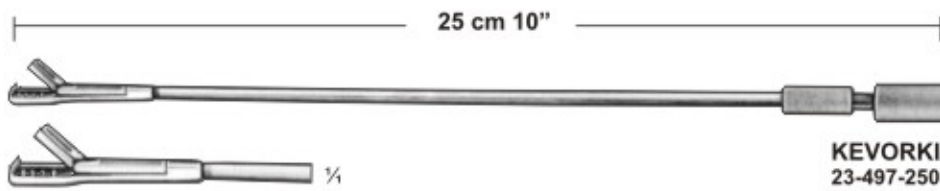

**KEVORKIAN**  
23-497-250  
25 cm, 10"

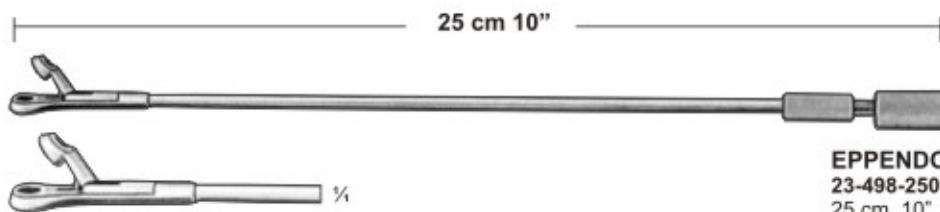

**EPPENDORF**  
23-498-250  
25 cm, 10"

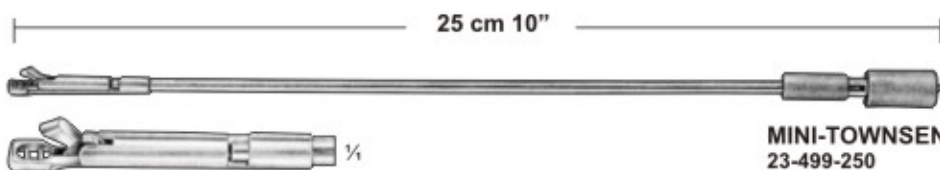

**MINI-TOWNSEND**  
23-499-250  
25 cm, 10"



23-495-001



## UTERINE BIOPSY FORCEPS

Probeexzisionszangen  
Pinzas para biopsia

Pinces pour biopsi  
Pinze per biopsia

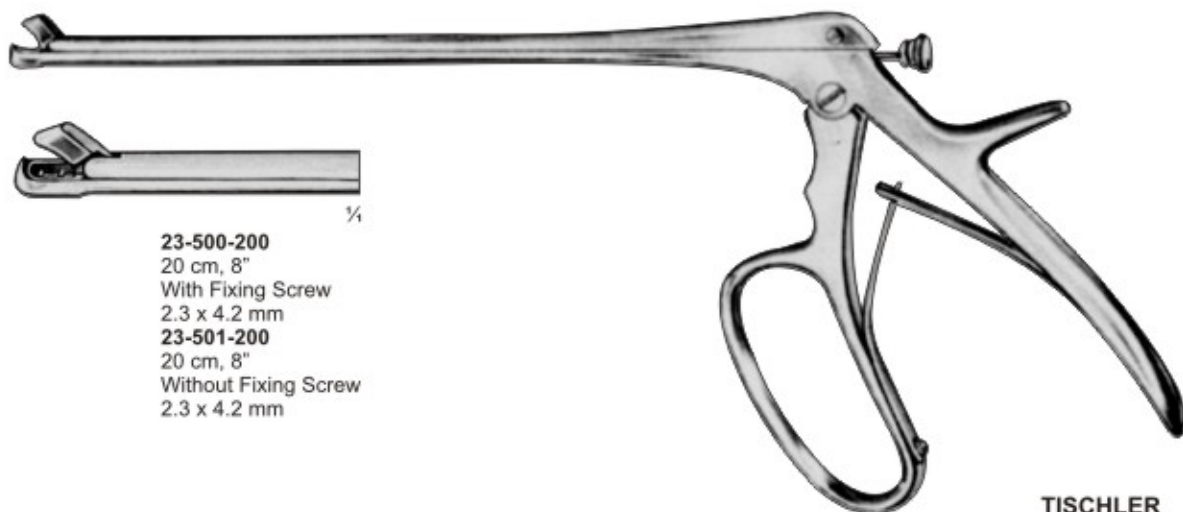

**23-500-200**  
20 cm, 8"  
With Fixing Screw  
2.3 x 4.2 mm  
**23-501-200**  
20 cm, 8"  
Without Fixing Screw  
2.3 x 4.2 mm

TISCHLER

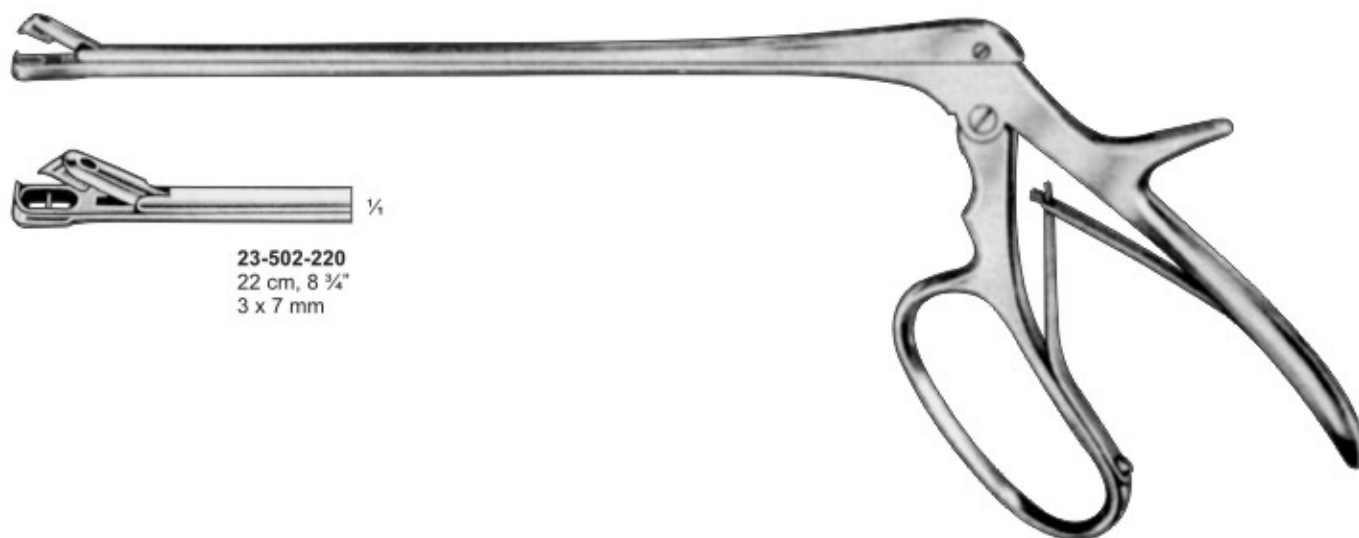

**23-502-220**  
22 cm, 8 1/4"  
3 x 7 mm

TISCHLER-MORGAN



**23-503-230**  
23 cm, 9"  
3 x 9.7 mm  
**23-504-250**  
25 cm, 10"  
3 x 9.7 mm

KEVORKIAN

# UTERINE BIOPSY FORCEPS



Probeexzisionszangen  
Pinzas para biopsia

Pinces pour biopsi  
Pinze per biopsia



**GELLHORN**  
23-505-230  
23 cm, 9"



**FAURE**  
23-506-230  
23 cm, 9"



**SCHUBERT**  
23-507-210 21 cm, 8 1/4"  
23-508-280 28 cm, 11"



**THOMS-GAYLOR**  
23-509-240  
24 cm, 9 1/2"



**SCHUBERT**  
23-510-260  
26 cm, 10 1/4"

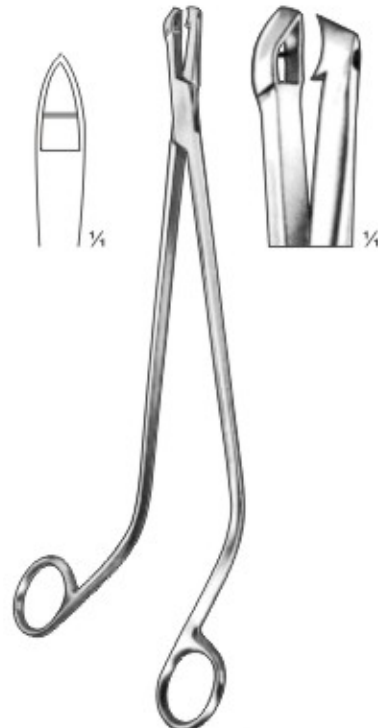

**TISCHLER**  
23-511-270  
27 cm, 10 1/2"



## UTERINE BIOPSY FORCEPS

Probeexzisionszangen  
Pinzas para biopsia

Pinces pour biopsi  
Pinze per biopsia



Fig. 1  
5 mm

Fig. 2  
7 mm

**SCHUMACHER-NAN-DOREN**  
23-512-240 Fig. 1  
23-513-240 Fig. 2  
24 cm, 9 1/2"



**VAN DOREN**  
23-514-250  
25 cm, 10"



**VAN DOREN**  
23-515-250  
25 cm, 10"



**NAEGELE**  
23-516-250  
25 cm, 10"



**SPELLIE**  
23-517-250  
25 cm, 10"



**BRAUN**  
23-518-300  
30 cm, 12"



**SPELLIE**  
23-519-300  
30 cm, 12"

# PLACENTA & OVUM FORCEPS



Abortuszangen  
Pinzas para aborto

Pinces placentaires et pour poste-abortum  
Pinze per placenta e per ovaie

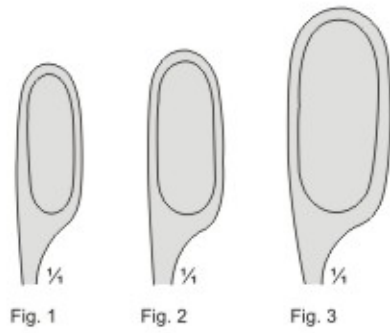

**WINTER**  
23-520-280 Fig. 1  
23-521-280 Fig. 2  
23-522-280 Fig. 3  
28 cm, 11"



**WINTER**  
23-523-280 Fig. 1  
23-524-280 Fig. 2  
23-525-280 Fig. 3  
28 cm, 11"

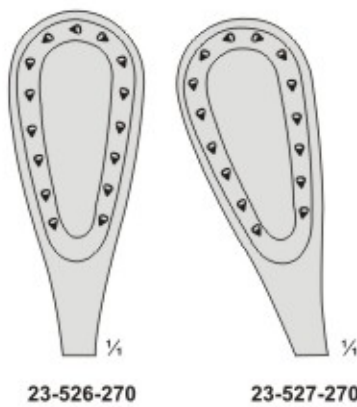

**SAENGER**  
27 cm, 10 1/2"

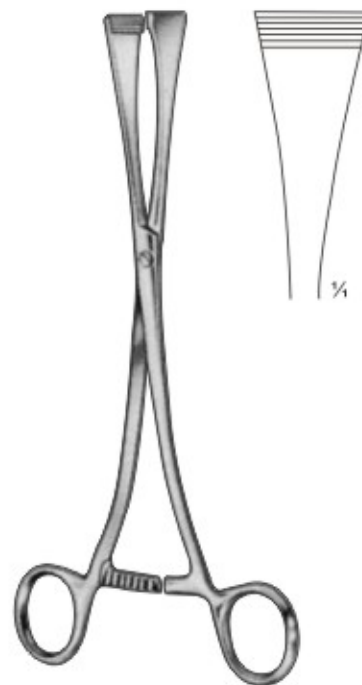

**GREEN-ARMYTAGE**  
23-528-210  
21 cm, 8 1/4"



**WALLICH**  
23-529-420  
42 cm, 16 1/2"





## OBSTETRICAL FORCEPS

Geburtszangen  
Forceps obstétricos

Forceps obstétriques  
Forcipi obstetrici

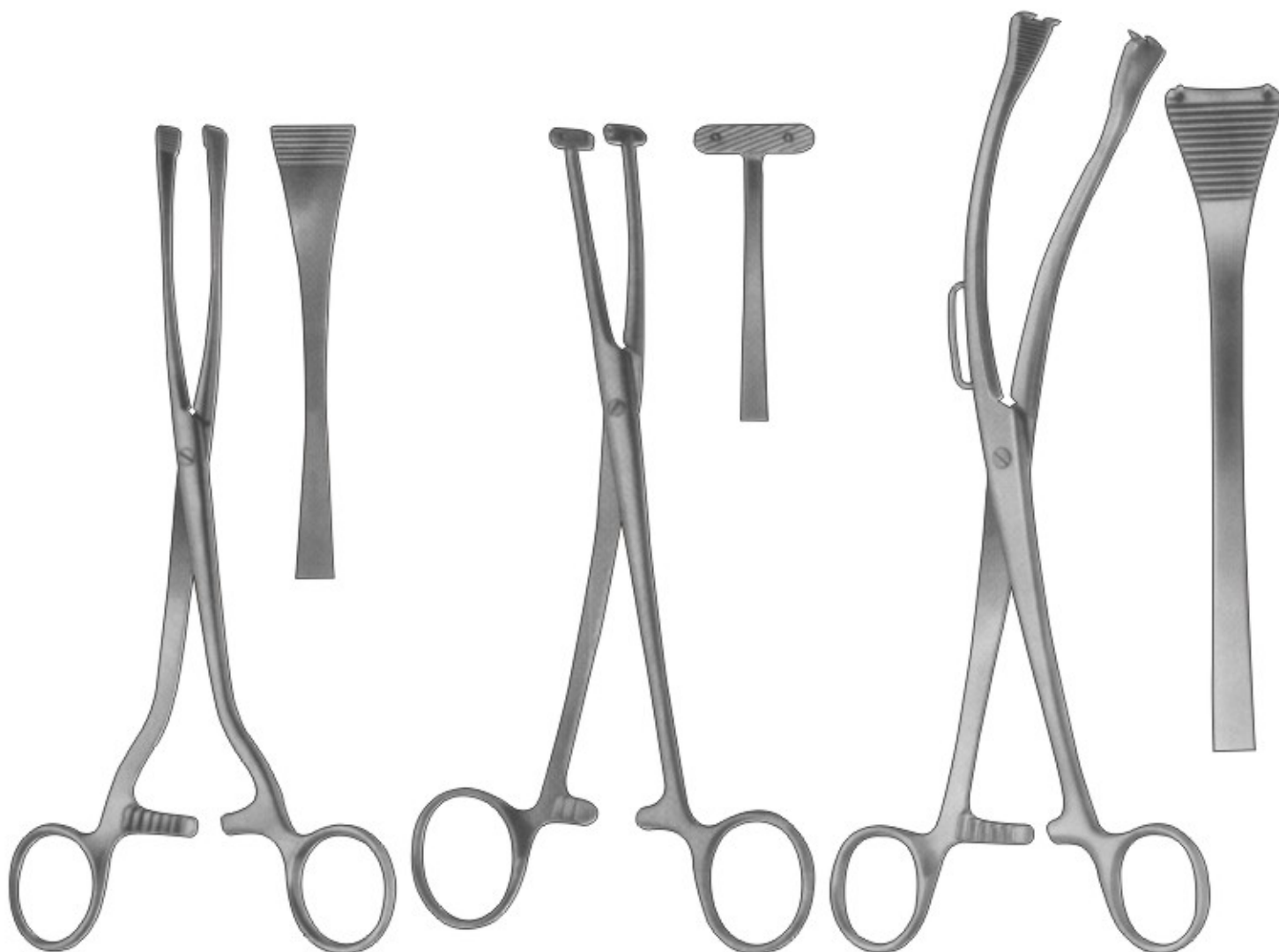

### GREEN-ARMYTAGE

23-530-220

caesarean section haemostatic  
forceps, for edges of the transverse  
incision in the lower segment  
22 cm, 8  $\frac{3}{4}$ "

### WILLETT

23-531-185

Scalpel Flap Forceps  
18.5 cm, 7  $\frac{1}{4}$ "

### GAUSS

23-532-260

Scalpel Flap Forceps  
26 cm, 10  $\frac{1}{4}$ "

# PELVIMETER, OBSTETRICAL FORCEPS

Beckenzirkel, Geburtszangen  
Pelvimetro, Forceps obstétricos

Pelvimètre, Forceps obstétriques  
Pelvimetri, Forcipi obstetrici



**THOLE**  
23-533-001  
for internal and external measurements, graduated in centimeters

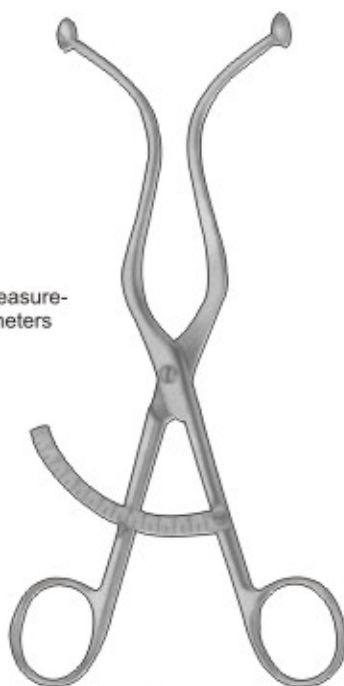

**DE LEE**  
23-534-001  
graduated in centimeters and inches



**COLLIN**  
23-535-001  
graduated in centimeters



**MARTIN**  
23-536-001  
graduated in centimeters



for internal measurements between symphysis and promontory

**COLLIN**  
23-537-001  
graduated in centimeters

The additional straight arm can be replaced. The pelvimeter with straight arm is used for localisation of the portio vaginalis uteri and of vaginal metastasis.



**BREISKY**  
23-538-001  
graduated in centimeters



## OBSTETRICAL FORCEPS

Geburtszangen  
Forceps obstétricos

Forceps obstétriques  
Forcipi obstetrici



**PIPER**  
23-539-440  
44 cm, 18"



**NAEGELE**  
23-540-360 36 cm, 14 1/4"  
23-541-400 40 cm, 15 3/4"



**SIMPSON**  
23-542-300  
30 cm, 12"



**SIMPSON-BRAUN**  
23-543-330 33 cm, 13 1/2"  
23-544-380 38 cm, 14 1/2"



**MCLEAN**  
23-545-360  
36 cm, 14 1/4"



**KIELLAND**  
23-546-410  
41 cm, 16"

# OBSTETRICAL FORCEPS



Geburtszangen  
Forceps obstétricos

Forceps obstétriques  
Forcipi obstetrici



**KIELLAND-LUIKART**  
23-547-410  
41 cm, 16"



**WRIGLEY**  
23-548-230  
23 cm, 9"



**DE LEE**  
23-549-300  
30 cm, 12"

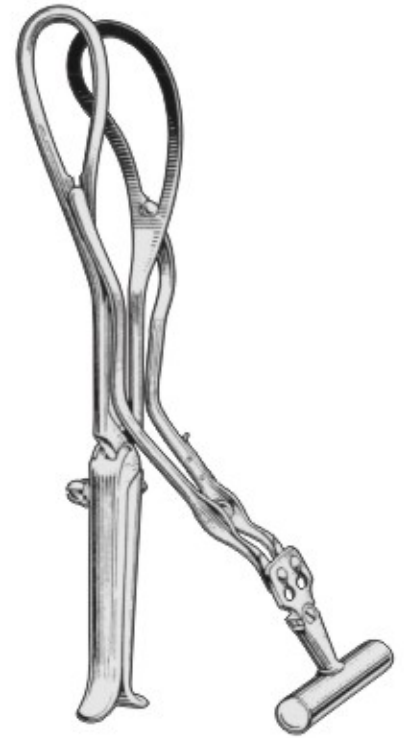

**MILNE MURRAY**  
23-550-001  
detach-able axis traction  
rod & handle.

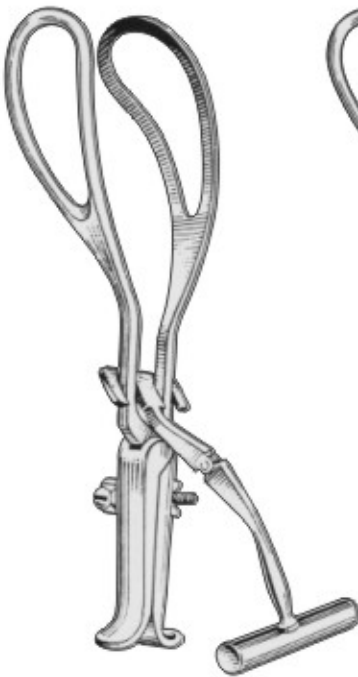

**HAIG FERGUSON**  
23-551-001  
detachable axis traction  
rod & handle.

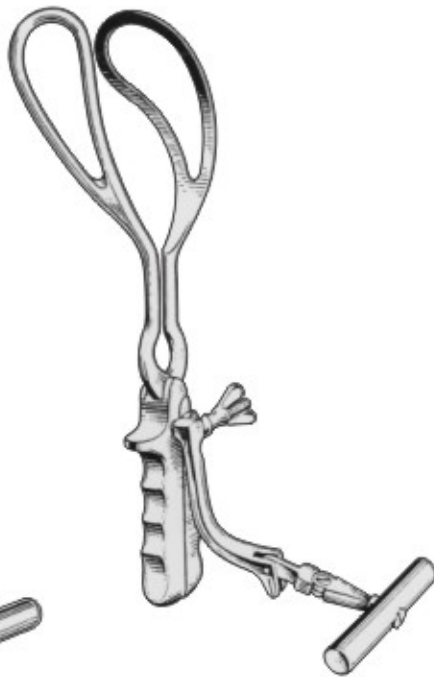

**BARNES-NEVILLE**  
23-552-001  
Simpson handles, detachable  
axis traction rod and handle.



**BRAUN**  
23-553-420  
42 cm, 16 1/4"

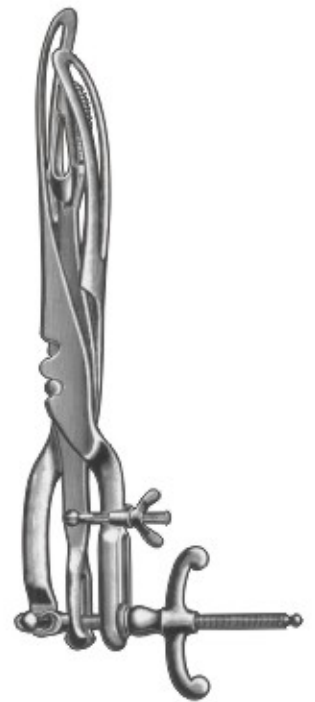

**TARNIER**  
23-554-440  
44 cm, 17 1/4"



# NEUROSURGERY

---

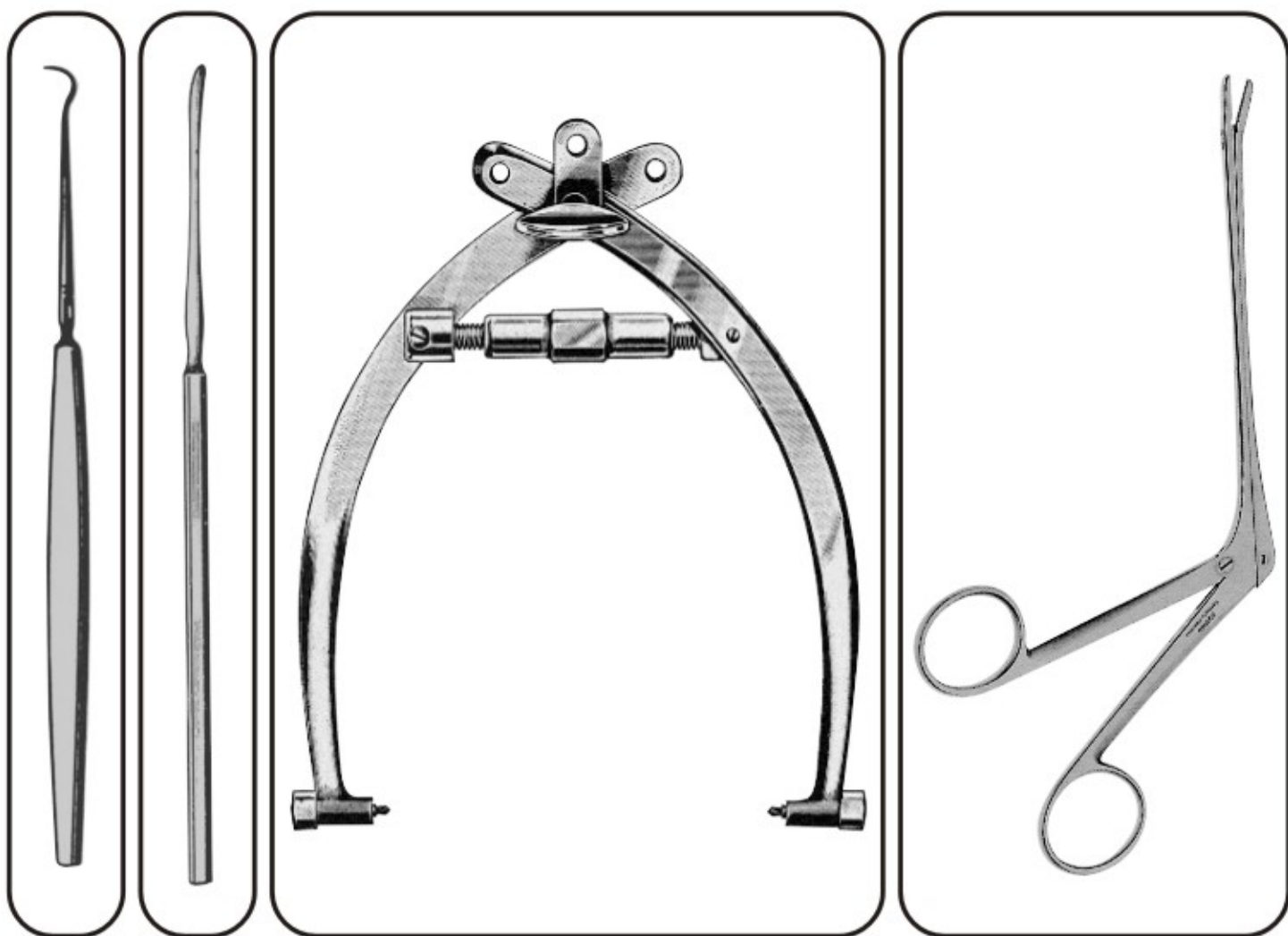

# RHOTON-MERZ BRAIN RETRACTOR SET



RHOTON-MERZ-Reaktorensatz  
Jeu d'écarteurs du cerveau de RHOTON-MERZ

Set di divaricatori cerebrali RHOTON-MERZ  
Juego de retractores cerebrales RHOTON-MERZ



**25-001-000**  
wire cable only



**25-002-001**  
Support only,  
flat brain spatulas,



**25-003-002**  
Support only,  
for brain spatulas  
with round shaft  
up to 5,5 mm diam.  
Fixing for flexible



**RIECHERT**  
**25-004-003**  
Fixation base, for skull  
mounting, holding 1  
flexible arms



**RIECHERT**  
**25-005-004**  
Fixation base, for skull  
mounting, holding 2  
flexible arms



**25-006-005**  
Fixation base, for skull  
mounting, holding 1  
flexible arms

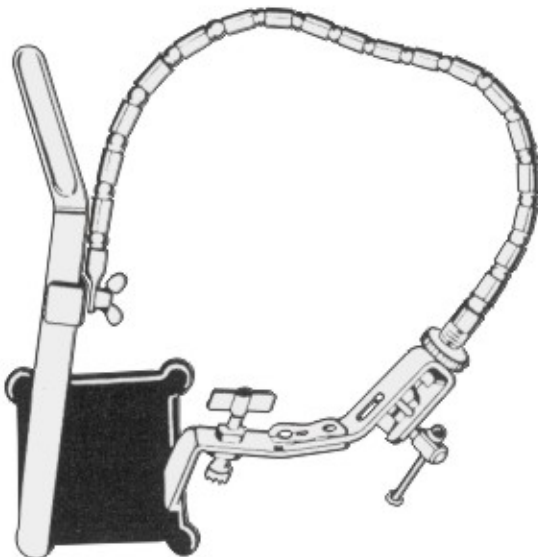

**LEYLA**  
Self-Retaining Brain Retractor  
with 1 flexible arm, complete consisting of  
**25-007-001**  
**25-008-002**  
**25-009-003**

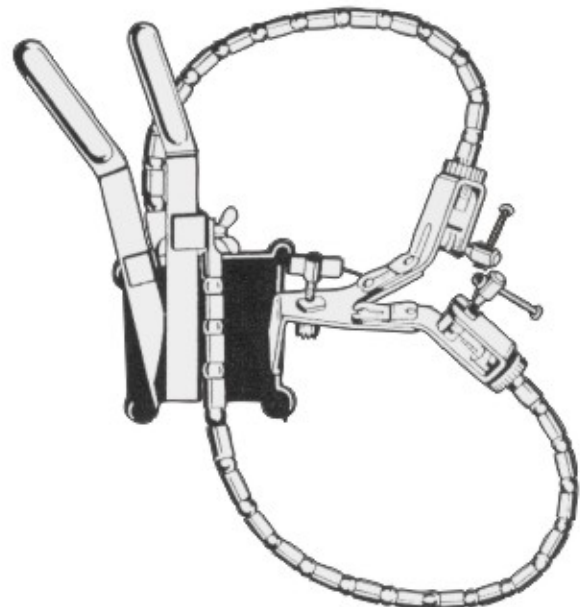

**LEYLA**  
Self-Retaining Brain Retractor  
with 2 flexible arms, complete consisting of  
**25-010-001**  
**25-011-002**  
**25-012-003**



## Hand drill, TWIST DRILLS, SPHERICAL BURRS

Handbohrapparate, Spiralbohrer, Kugelfräser  
Perforadores de mano, Brocas espirales, Taladros esféricos

Perforateurs à main, Meches hélicoidales, Fraises sphériques  
Perforatori a mano, Punte a spirale, Frese sferiche

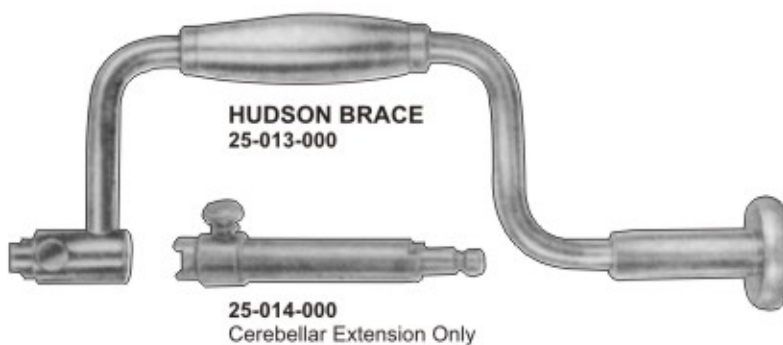

**HUDSON**  
25-015-000  
Ø 9 mm



**HUDSON**  
25-016-000  
Ø 14 mm



**HUDSON**  
25-017-000  
Ø 16 mm



**HUDSON**  
25-018-000  
Ø 22 mm



**ADSON**  
25-019-000  
Ø 15 mm



**Mc KENZIE**  
25-020-000  
Ø 13 mm



**CUSHING**  
25-021-000  
Ø 14 mm



25-022-000  
Ø 2 mm

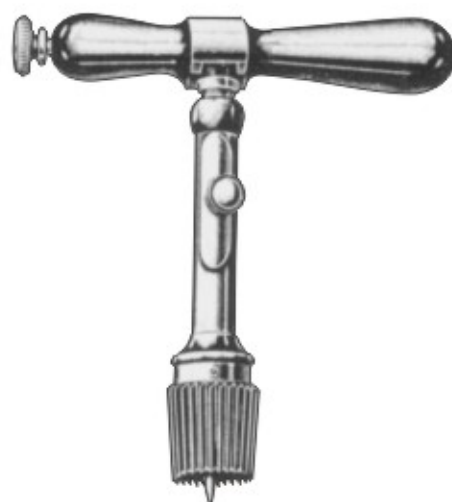

**GALT**

25-023-000 Ø 12,5 mm  
25-024-000 Ø 16 mm  
25-025-000 Ø 19 mm

# SKULL TRACTION TONGS



Schadelhalter  
Estribos De Tracción Craneal

Pinces De Traction Crânienne  
Pinza Per Trazione Craniale

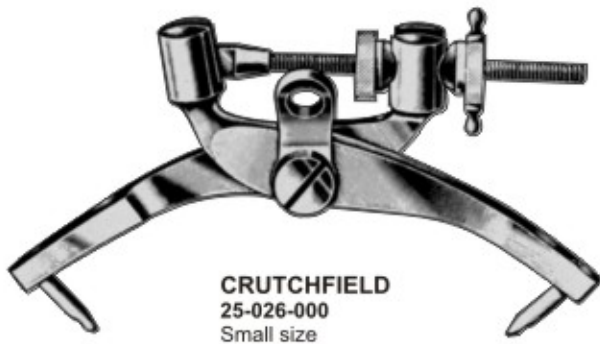

**CRUTCHFIELD**  
25-026-000  
Small size

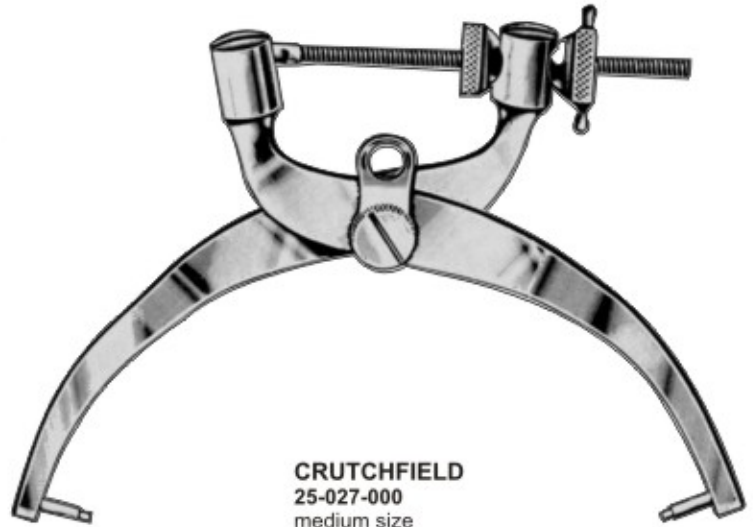

**CRUTCHFIELD**  
25-027-000  
medium size



**25-028-000**  
Drill points only



**25-029-000**



**CRUTCHFIELD**  
25-030-000  
Large size





# RONGEURS

Laminektomieztangen  
Pinzas Para Laminectomia

Pinces Pour Laminectomie  
Pinze Per Laminectomia

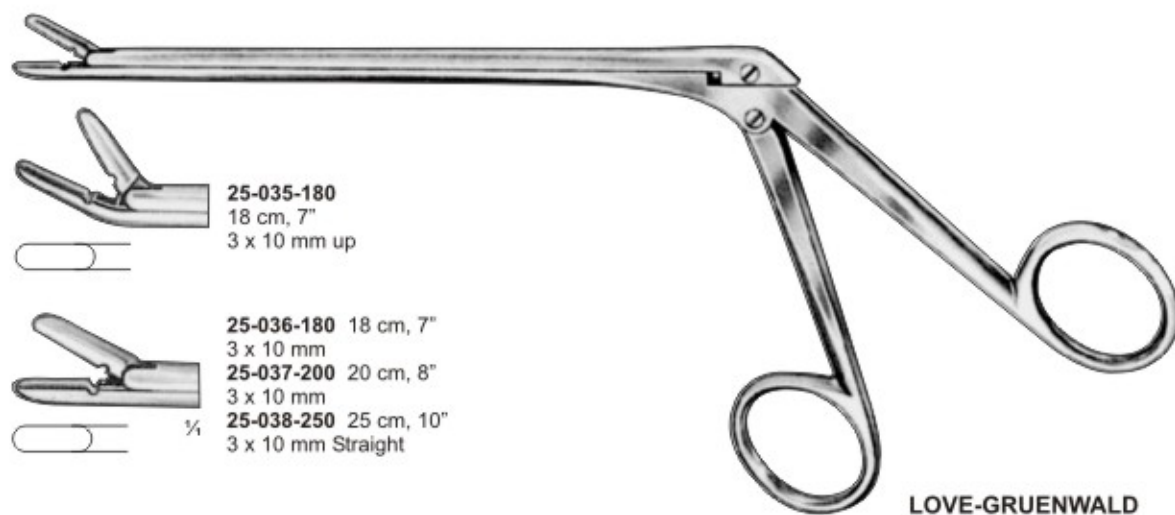
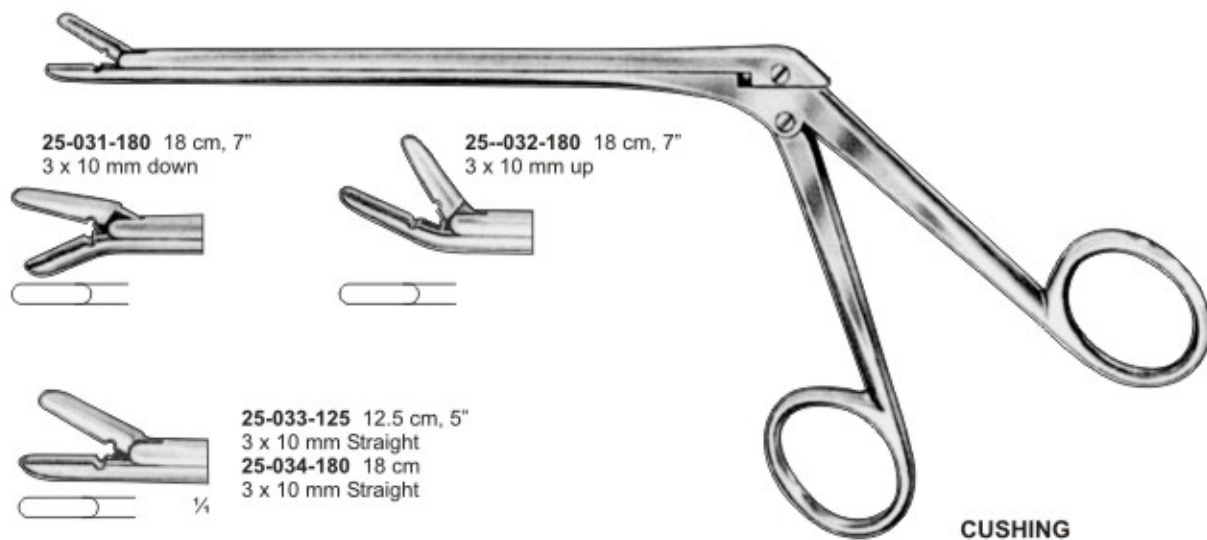

# RONGEURS



Laminektomieztangen  
Pinzas Para Laminectomía

Pinces Pour Laminectomie  
Pinze Per Laminectomia

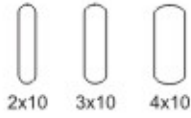

Straight Shaft	120 mm	150 mm	180 mm
Bite 2 x 10 mm	<b>25-041-00</b>	<b>25-044-00</b>	<b>25-047-00</b>
Bite 3 x 10 mm	<b>25-042-00</b>	<b>25-045-00</b>	<b>25-048-00</b>
Bite 4 x 10 mm	<b>25-043-00</b>	<b>25-046-00</b>	<b>25-049-00</b>



Angled - up Shaft	120 mm	150 mm	180 mm
Bite 2 x 10 mm	<b>25-050-00</b>	<b>25-053-00</b>	<b>25-056-00</b>
Bite 3 x 10 mm	<b>25-051-00</b>	<b>25-054-00</b>	<b>25-057-00</b>
Bite 4 x 10 mm	<b>25-052-00</b>	<b>25-055-00</b>	<b>25-058-00</b>



Angled - down Shaft	120 mm	150 mm	180 mm
Bite 2 x 10 mm	<b>25-059-00</b>	<b>25-062-00</b>	<b>25-065-00</b>
Bite 3 x 10 mm	<b>25-060-00</b>	<b>25-063-00</b>	<b>25-066-00</b>
Bite 4 x 10 mm	<b>25-061-00</b>	<b>25-064-00</b>	<b>25-067-00</b>

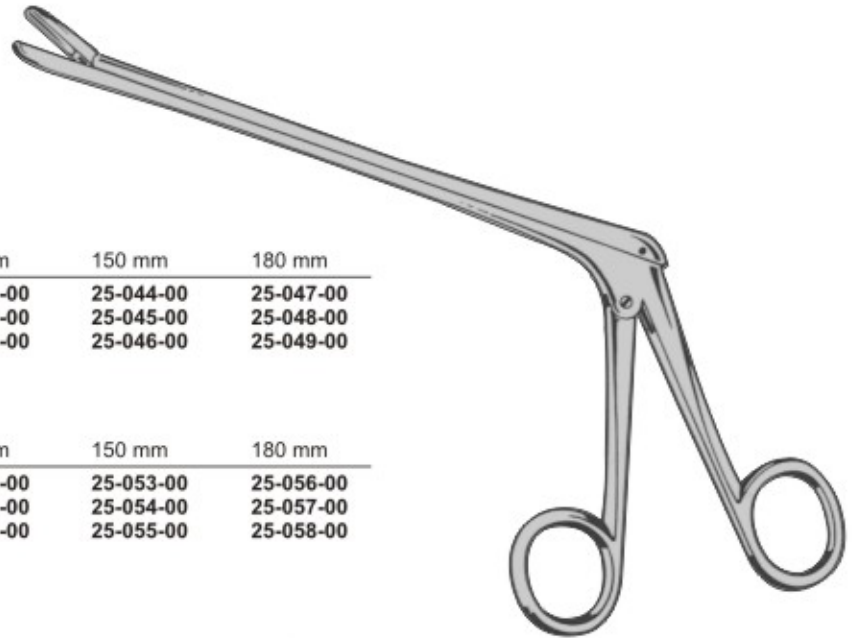

**CUSHING  
LOVE - GRUENWALD  
SPURLING**



**25-068-00**  
Straight



**25-069-00**  
Angled-up



**25-070-00**  
Angled-down



Shaft 150 mm  
Bite 6 x 10 mm



**CLOWARD-TYPE**  
Serrated cup jaws





# LAMINECTOMY RONGEURS

Laminektomieztangen  
Pinzas Para Laminectomia

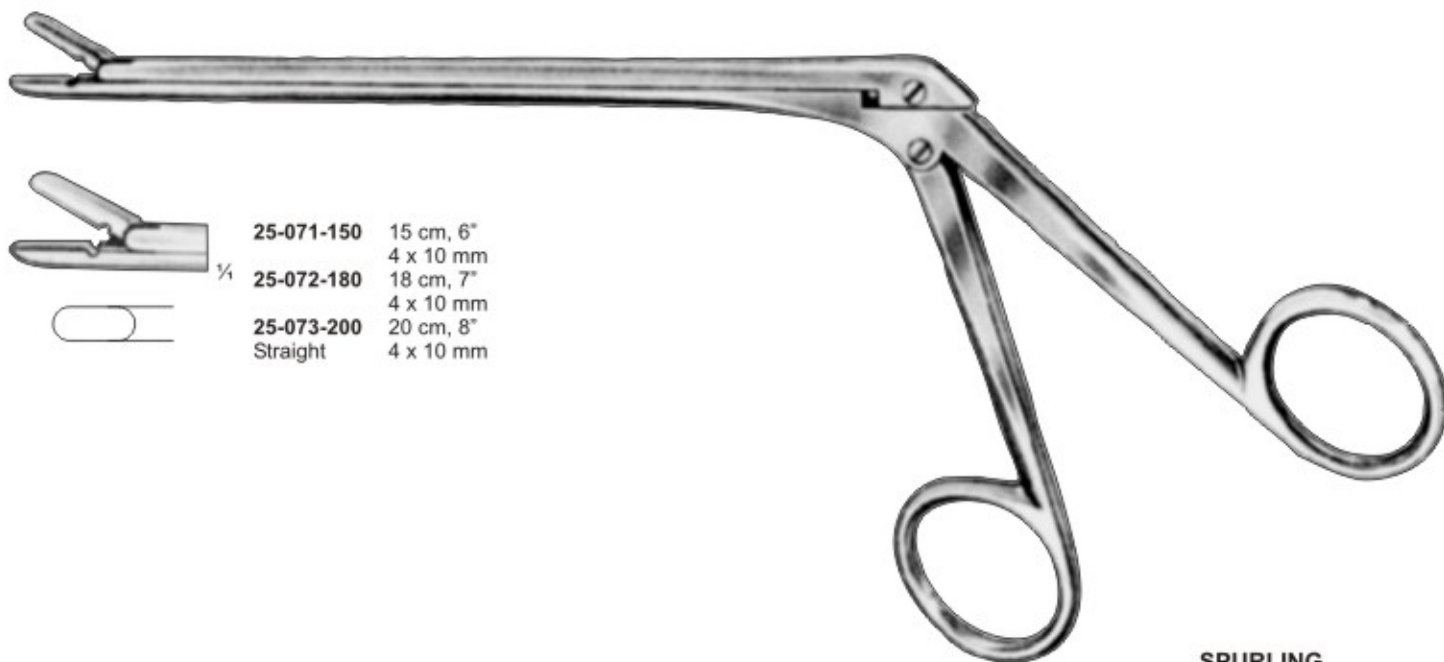
Pinces Pour Laminectomie  
Pinze Per Laminectomia

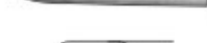

SPURLING

	<b>25-071-150</b>	15 cm, 6"
		4 x 10 mm
	<b>25-072-180</b>	18 cm, 7"
		4 x 10 mm
	<b>25-073-200</b>	20 cm, 8"
	Straight	4 x 10 mm

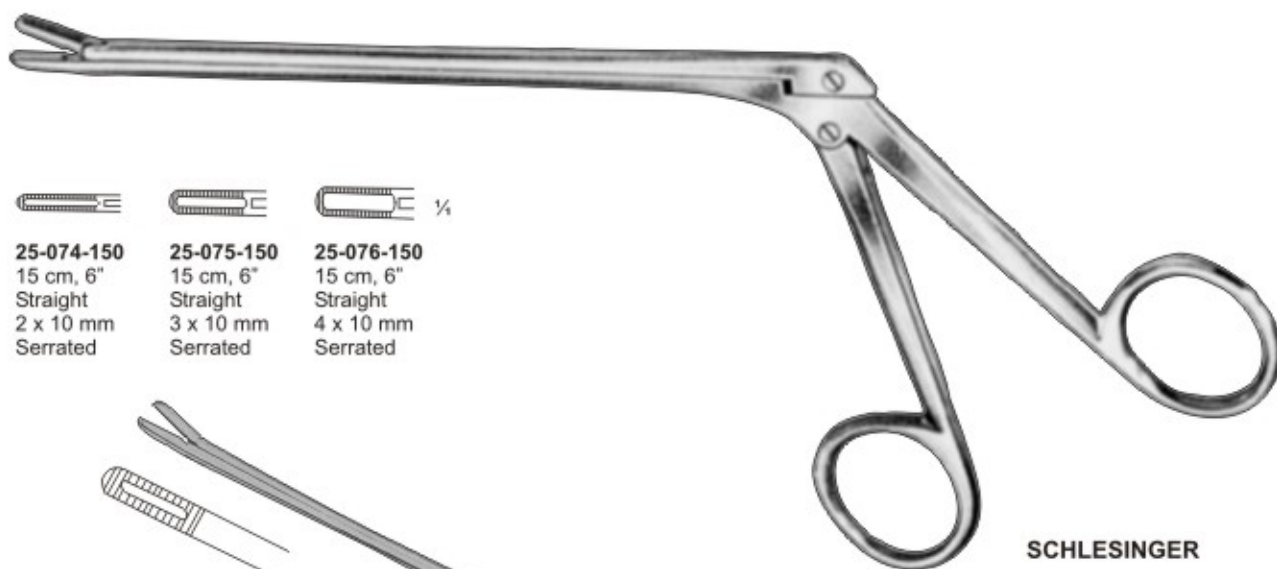

SCHLESINGER

			¼
<b>25-074-150</b>	<b>25-075-150</b>	<b>25-076-150</b>	
15 cm, 6"	15 cm, 6"	15 cm, 6"	
Straight	Straight	Straight	
2 x 10 mm	3 x 10 mm	4 x 10 mm	
Serrated	Serrated	Serrated	

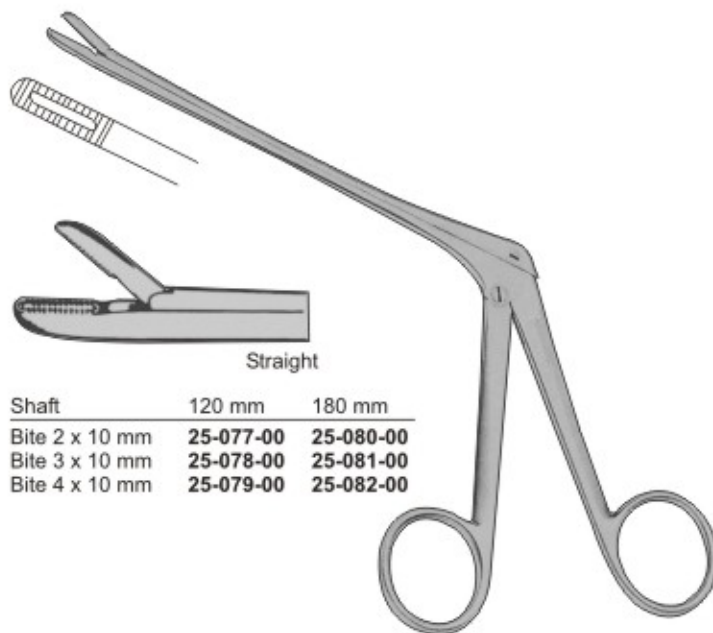

SCHLESINGER

Shaft	120 mm	180 mm
Bite 2 x 10 mm	<b>25-077-00</b>	<b>25-080-00</b>
Bite 3 x 10 mm	<b>25-078-00</b>	<b>25-081-00</b>
Bite 4 x 10 mm	<b>25-079-00</b>	<b>25-082-00</b>

# LAMINECTOMY RONGEURS



Laminektomieztangen  
Pinzas Para Laminectomía

Pinces Pour Laminectomie  
Pinze Per Laminectomia

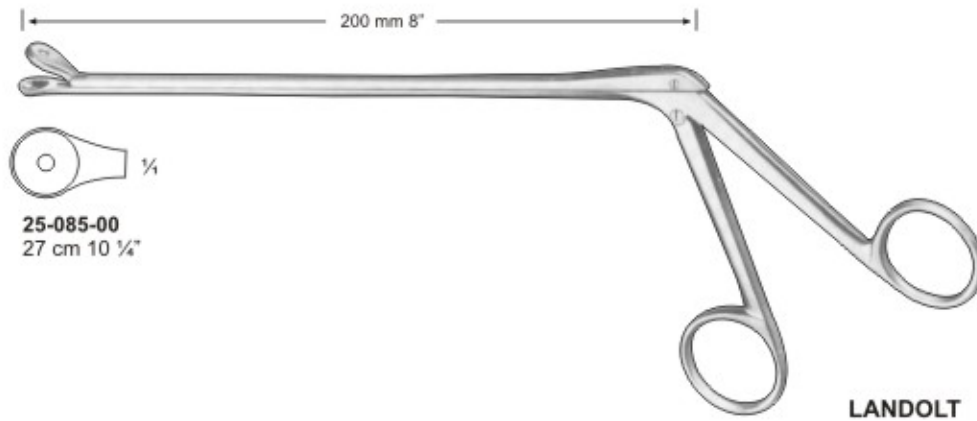
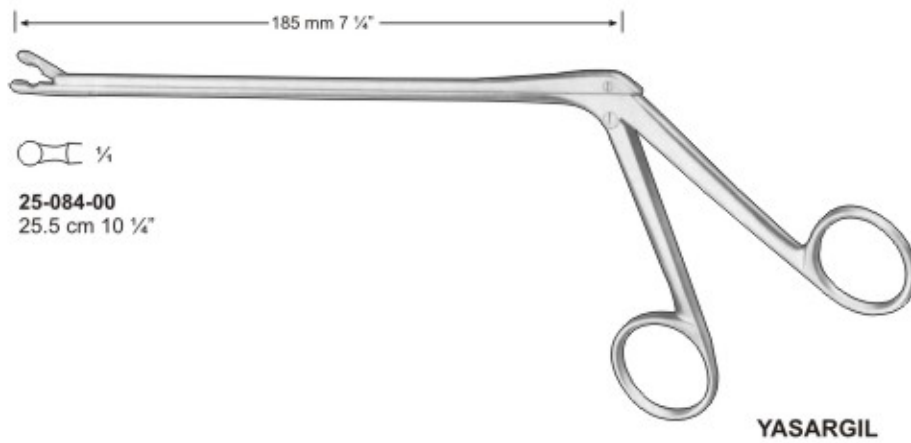
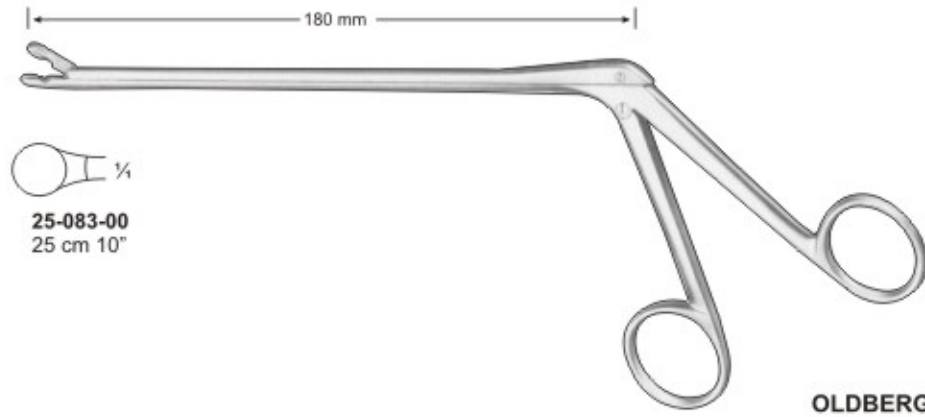



## LAMINECTOMY RONGEURS

Laminektomieztangen  
Pinzas Para Laminectomía

Pinces Pour Laminectomie  
Pinze Per Laminectomia

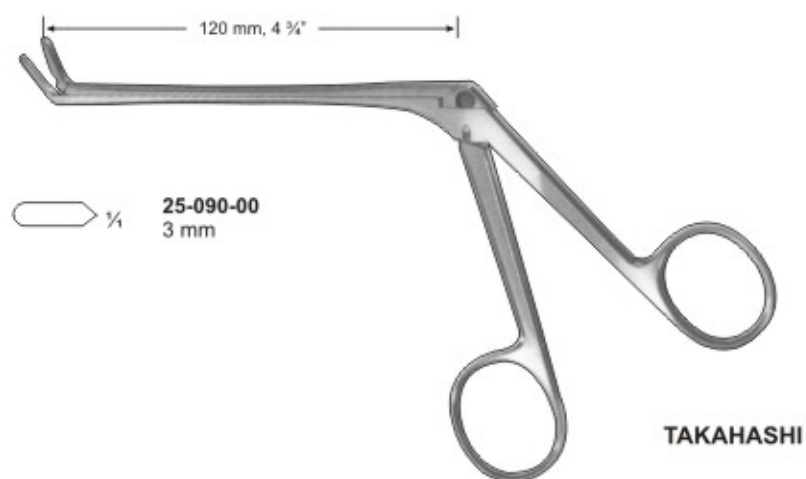
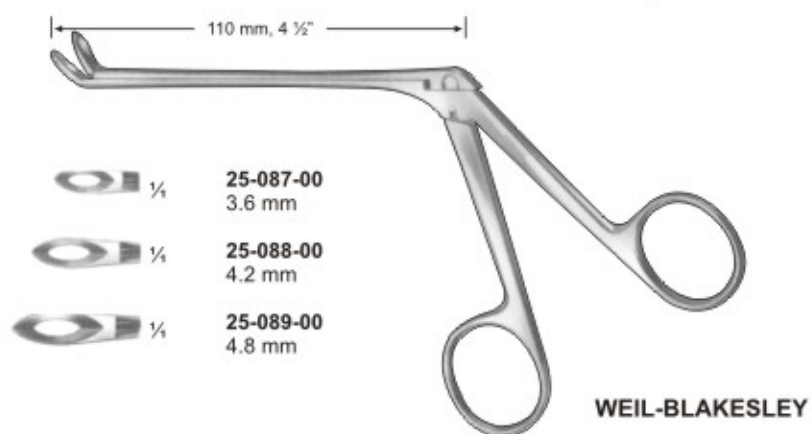
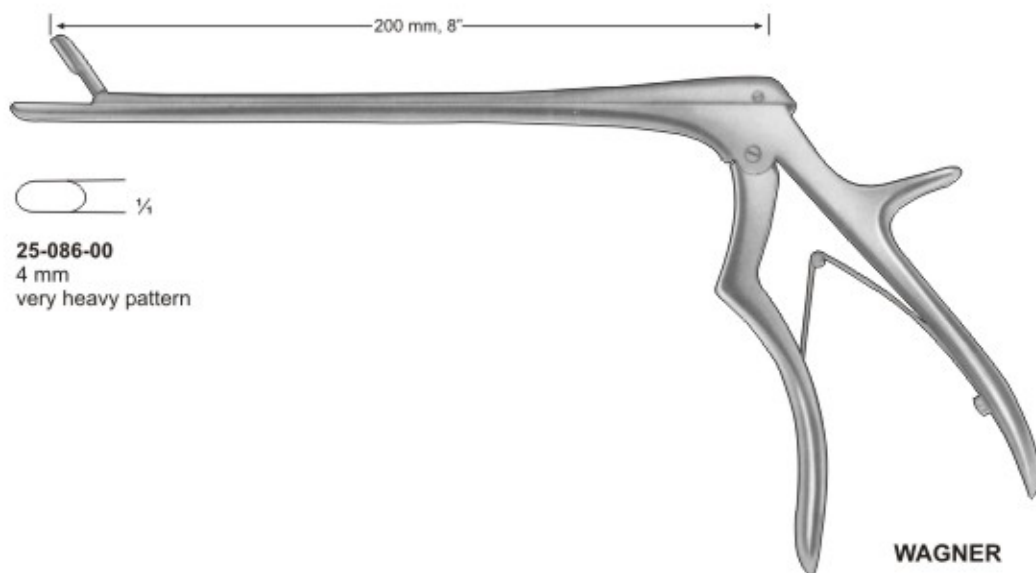

# LAMINECTOMY RONGEURS



Laminektomieztangen  
Pinzas Para Laminectomía

Pinces Pour Laminectomie  
Pinze Per Laminectomia

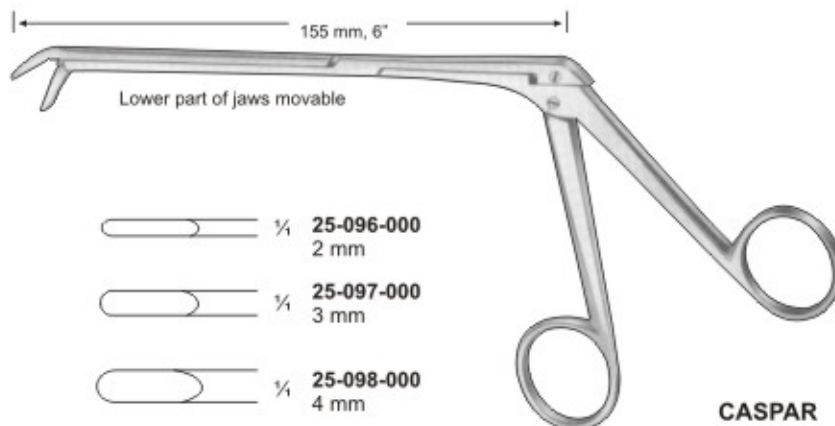
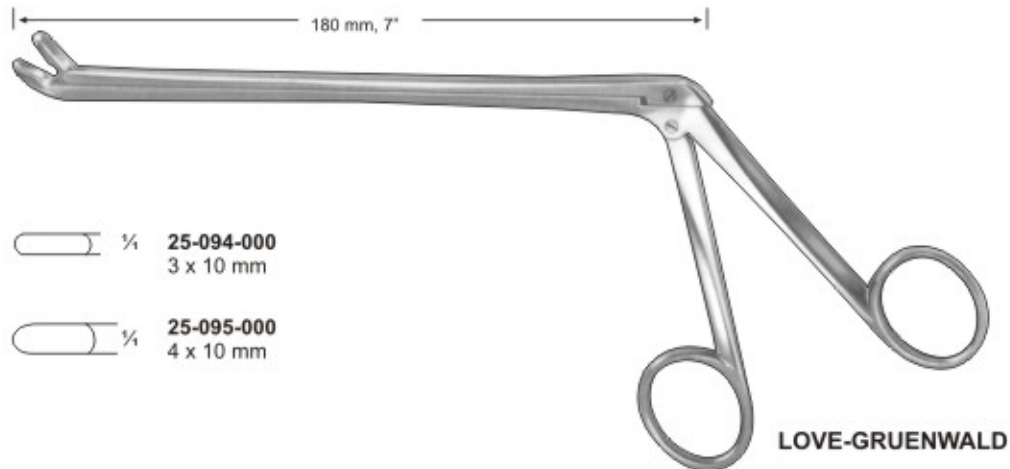
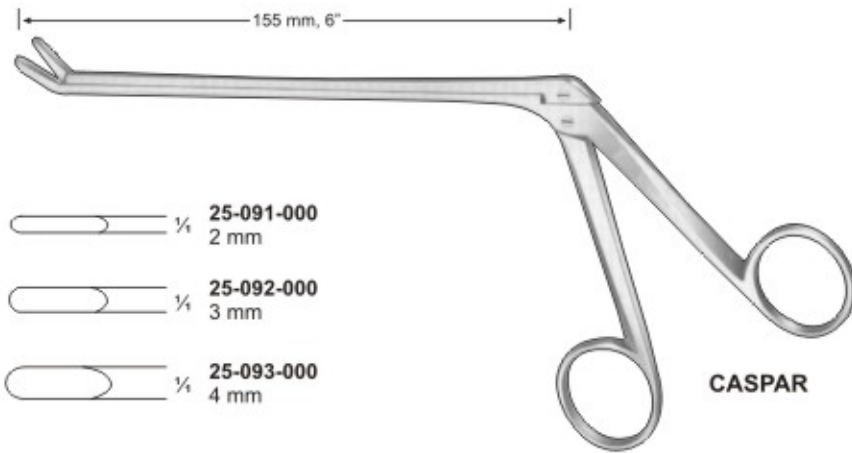



## LAMINECTOMY PUNCHES

Laminektomiestanzen  
Pinzas Cortantes Para Laminectomía

Pinces Emporte-pièces à Laminectomie  
Pinze Taglienti Per Laminectomia

2.0 mm 3.0 mm 3.5 mm



90°  
Up-cutting  
Shaft 140 mm  
Bite 2.0 mm **25-099-000**  
Bite 3.0 mm **25-100-000**  
Bite 3.5 mm **25-101-000**



90°  
Down-cutting  
Shaft 140 mm  
Bite 2.0 mm **25-102-000**  
Bite 3.0 mm **25-103-000**  
Bite 3.5 mm **25-104-000**

160 mm, 6 1/4"



**HAJEK-KOFLER**  
25-105-000  
3.5 mm

**HAJEK-KOFLER**

1.0 mm  
2.5 mm  
4.0 mm

**CITELLI**  
25-106-000 1.0 mm  
25-107-000 2.5 mm  
25-108-000 4.0 mm



LOVE-KERRISON  
LAMINECTOMY PUNCH

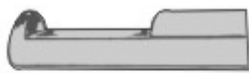

Forward 90° Regular Footplate

□	2 mm bite forward	
	<b>25-109-000</b>	150 mm
	<b>25-110-000</b>	200 mm

□	3 mm bite forward	
	<b>25-111-000</b>	150 mm
	<b>25-112-000</b>	200 mm

□	4 mm bite forward	
	<b>25-113-000</b>	150 mm
	<b>25-114-000</b>	200 mm

□	5 mm bite forward	
	<b>25-115-000</b>	150 mm
	<b>25-116-000</b>	200 mm

□	6 mm bite forward	
	<b>25-117-000</b>	150 mm
	<b>25-118-000</b>	200 mm



Up 40° Regular footplate

□	2 mm bite up	
	<b>25-119-000</b>	150 mm
	<b>25-120-000</b>	200 mm

□	3 mm bite up	
	<b>25-121-000</b>	150 mm
	<b>25-122-000</b>	200 mm

□	4 mm bite up	
	<b>25-123-000</b>	150 mm
	<b>25-124-000</b>	200 mm

□	5 mm bite up	
	<b>25-125-000</b>	150 mm
	<b>25-126-000</b>	200 mm

□	6 mm bite up	
	<b>25-127-000</b>	200 mm



Down 90° Regular footplate

□	3 mm bite down	
	<b>25-128-000</b>	150 mm
	<b>25-129-000</b>	200 mm

□	4 mm bite down	
	<b>25-130-000</b>	150 mm
	<b>25-131-000</b>	200 mm

□	5 mm bite down	
	<b>25-132-000</b>	150 mm
	<b>25-133-000</b>	200 mm





# LAMINECTOMY PUNCHES

Laminektomiestanzen  
Pinzas Cortantes Para Laminectomía

Pinces Emporte-pièces à Laminectomie  
Pinze Taglienti Per Laminectomia



**THIN FOOTPLATE  
KERRISON PUNCH**



Forward 90° Thin footplate

□	1 mm bite forward
<b>25-134-000</b>	150 mm
<b>25-135-000</b>	180 mm
<b>25-136-000</b>	200 mm

□	2 mm bite forward
<b>25-137-000</b>	150 mm
<b>25-138-000</b>	180 mm
<b>25-139-000</b>	200 mm

□	3 mm bite forward
<b>25-140-000</b>	150 mm
<b>25-141-000</b>	180 mm
<b>25-142-000</b>	200 mm

□	4 mm bite forward
<b>25-143-000</b>	150 mm
<b>25-144-000</b>	180 mm
<b>25-145-000</b>	200 mm

□	5 mm bite forward
<b>25-146-000</b>	150 mm
<b>25-147-000</b>	180 mm
<b>25-148-000</b>	200 mm



Up 40° Thin footplate

□	1 mm bite up
<b>25-149-000</b>	180 mm

□	2 mm bite up
<b>25-150-000</b>	180 mm

□	3 mm bite up
<b>25-151-000</b>	180 mm

□	4 mm bite up
<b>25-152-000</b>	180 mm

□	5 mm bite up
<b>25-153-000</b>	180 mm



Down 90° Thin footplate

□	1 mm bite down
<b>25-154-000</b>	180 mm

□	2 mm bite down
<b>25-155-000</b>	180 mm

□	3 mm bite down
<b>25-156-000</b>	180 mm

□	4 mm bite down
<b>25-157-000</b>	180 mm

□	5 mm bite down
<b>25-158-000</b>	180 mm

# LAMINECTOMY RONGEURS



Laminektomieztangen  
Pinzas Para Laminectomía

Pinces Pour Laminectomie  
Pinze Per Laminectomia

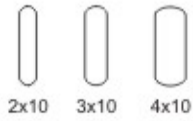

Straight	
Shaft	180 mm
Bite 2 x 10 mm	<b>25-159-000</b>
Bite 3 x 10 mm	<b>25-160-000</b>
Bite 4 x 10 mm	<b>25-161-000</b>



Angled - up	
Shaft	180 mm
Bite 2 x 10 mm	<b>25-162-000</b>
Bite 3 x 10 mm	<b>25-163-000</b>
Bite 4 x 10 mm	<b>25-164-000</b>



Angled - down	
Shaft	180 mm
Bite 2 x 10 mm	<b>25-165-000</b>
Bite 3 x 10 mm	<b>25-166-000</b>
Bite 4 x 10 mm	<b>25-167-000</b>

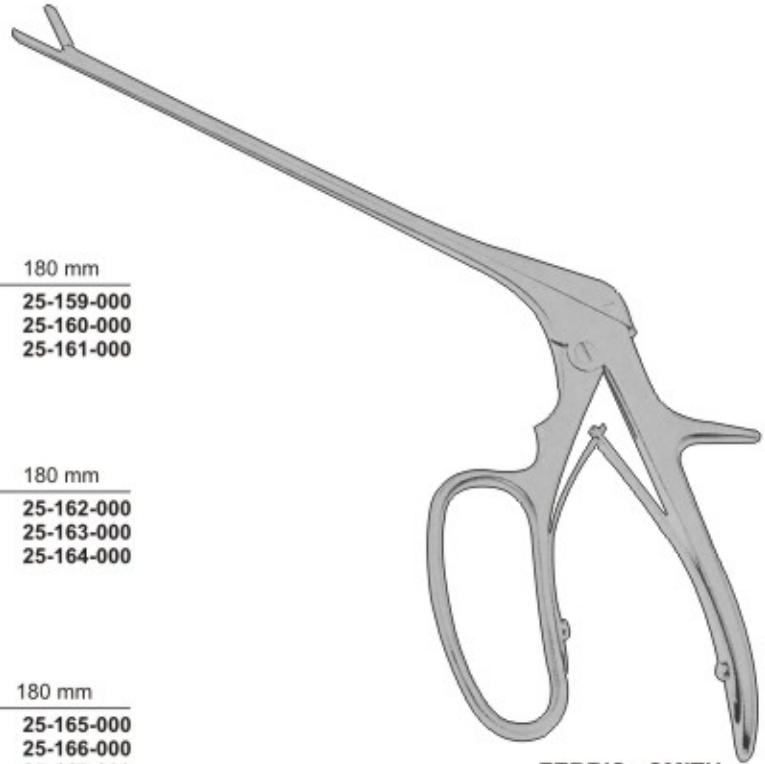

**FERRIS - SMITH**

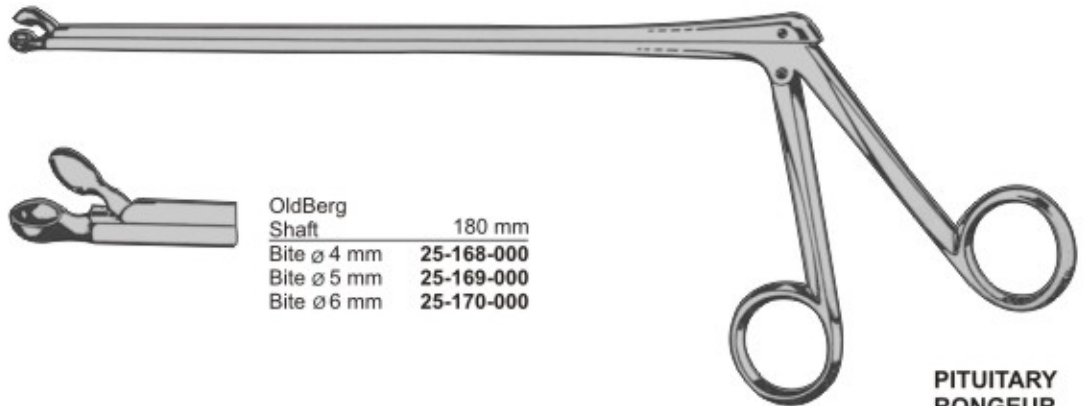

OldBerg	
Shaft	180 mm
Bite $\varnothing$ 4 mm	<b>25-168-000</b>
Bite $\varnothing$ 5 mm	<b>25-169-000</b>
Bite $\varnothing$ 6 mm	<b>25-170-000</b>

**PITUITARY  
RONGEUR**



## LAMINECTOMY RONGEURS

Laminektomieztangen  
Pinzas Para Laminectomía

Pinces Pour Laminectomie  
Pinze Per Laminectomia

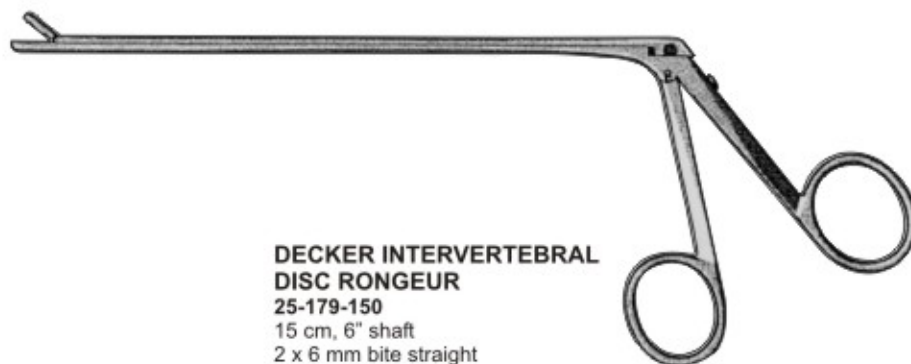
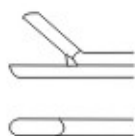
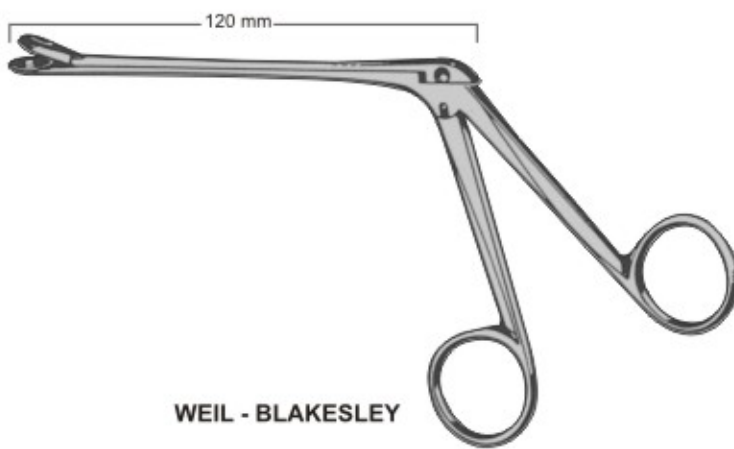
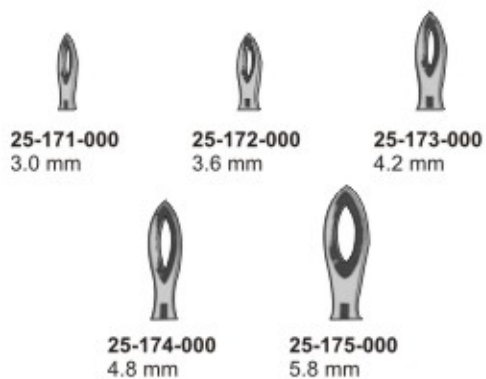

# LAMINECTOMY RONGEURS



Laminektomieztangen  
Pinzas Para Laminectomía

Pinces Pour Laminectomie  
Pinze Per Laminectomia



Working length 14 mm



**MICRO GRASPING  
FORCEPS**  
25-180-000  
serrated, straight



**MICRO ALLIGATOR  
SCISSORS**  
25-181-000  
straight



**25-182-000**  
Ø1.0 mm  
Straight



**25-183-000**  
Ø2.0 mm  
Straight



**25-184-000**  
Ø3.0 mm  
Straight



**MIRCO CUP  
FORCEPS**



**25-185-000**  
Ø1.0 mm  
angled up



**25-186-000**  
Ø2.0 mm  
curved to right



**25-187-000**  
Ø3.0 mm  
curved to left



**25-188-180**  
Grasping Forceps  
Ø 3 mm



**25-189-180**  
Cup Forceps  
Ø 2 mm



**25-190-180**  
Alligator Scissors  
Ø 2 mm



**MICRO ALLIGATOR  
FORCEPS**  
with tubular shaft  
18 cm, 7"



# DURA HOOKS / NERVE HOOKS

*Duramesser, Durahaken,  
Durahaken, Nerv-und Gefäßhäkchen*

*Couteaux Pour Dure-mere, Crochets Pour Dure-mère,  
Crochets Pour Dure-mère, Crochets à Nerfs Et à Vaisseaux*



**SCOVILLE**  
25-191-300  
30 cm, 12"  
Nerve Hook and  
Dissector



**SCOVILLE**  
25-192-300  
30 cm, 12"  
Nerve Hook and  
Dissector



**SCOVILLE**  
25-193-300  
30 cm, 12"  
Sympathectomy Hook  
and Dissector



**25-194-190**  
Davis  
4 mm, 19 cm, 7 1/2"



**25-195-200**  
Sachs  
3 mm, 20 cm, 8"



**25-196-200**  
Sachs  
6 mm, 20 cm, 8"

## NERVE SEPARATOR & SPATULA



**FRAZIER**  
25-197-125  
12.5 cm, 5"



**GILLIES**  
19 cm, 7 1/2"



**25-198-190**  
Small



**25-199-190**  
large



**25-200-130**  
Straight  
13 cm, 5"



**LAHEY CLINIC**  
25-201-130  
13 cm, 5"



**SACHS**  
25-202-185  
18.5 cm, 7 1/2"



**25-203-160**  
16 cm, 6 1/2"



**TOENNIS**  
25-204-150  
15 cm, 6"



**DURA  
TWIST HOOK**  
25-205-140  
14 cm, 5 1/2"

# CRANIAL RONGEURS, DURA DISSECTORS



Schädelzangen, Duradissektoren

Pinzas Sacabocados Craneales, Disecadores Para Duramadre

Pinces Emporte-pièces Crâniennes, Dissecteurs à Dure-mère

Pinze Per Craniectomia, Dissettori Per La Dura-madre



**SACHS**  
25-206-160  
21 cm, 8 1/4"



**MILLIGAN**  
25-207-160  
21 cm, 8 1/4"



**SACHS**  
25-208-160  
21 cm, 8 1/4"



**25-209-160**  
22 cm, 8 3/4"



**PENFIELD**  
25-210-160  
17.5 cm, 7"



**PENFIELD**  
25-211-160  
19.5 cm, 7 3/4"



**PENFIELD**  
25-212-160  
19.5 cm, 7 3/4"



**25-213-220**  
22 cm, 8 3/4"  
Straight



## CRANIAL RONGEURS, DURA DISSECTORS

Schädelzangen, Duradissektoren

Pinzas Sacabocados Craneales, Disecadores Para Duramadre

Pinces Emporte-pièces Crâniennes, Dissecteurs à Dure-mère

Pinze Per Craniectomia, Dissettori Per La Dura-madre



**RANEY**  
25-214-160  
16 cm, 6 1/2"



**RANEY**  
25-215-017  
1.7cm, 3/4"

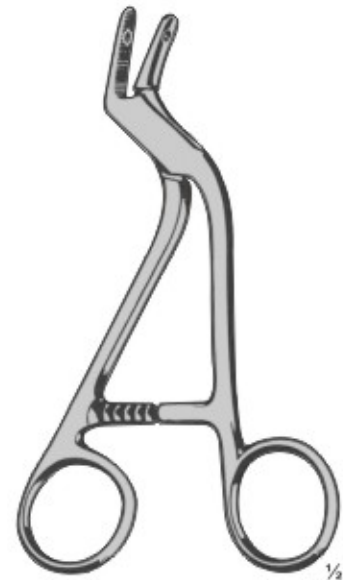

**ADSON**  
25-216-150  
15 cm, 6"  
Drill Guide and  
Dura Protector

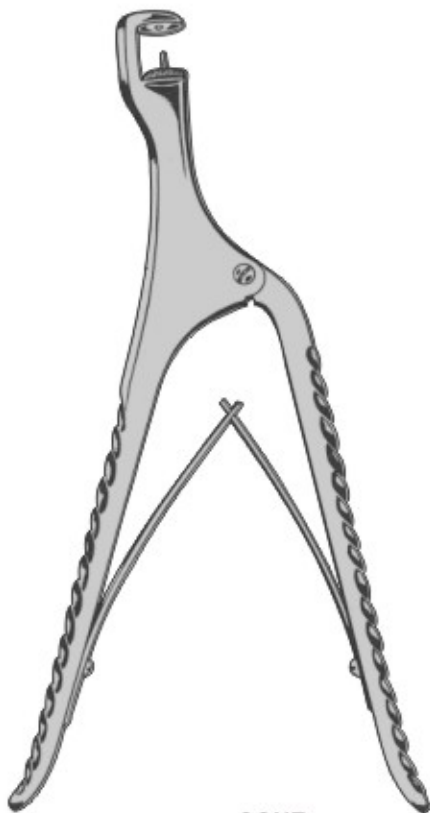

**CONE**  
25-217-200 20 cm 8"  
25-218-230 23 cm 9"  
Skull Punch



**DAHLGREN**  
25-219-200  
20 cm, 8"  
Complete with 2 Blades



**DE VILBISS**  
25-220-210  
Skull cutting forceps  
21cm, 8 1/4"

# LAMINA SPREADERS

Wirbelkörperspreizer  
Separadores Para Cuerpos Vertebrales

Ecarteurs Pour Corps Vertébraux  
Separatori Per Vertebre



**INGE**  
25-221-160  
16 cm, 6 1/2"  
Small pattern

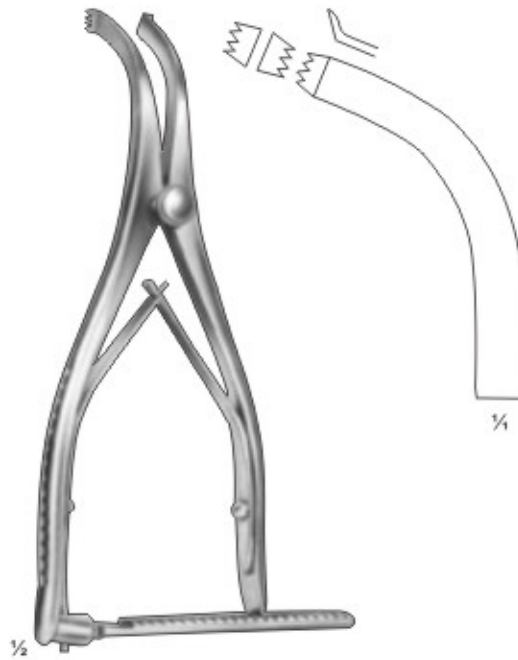

**INGE**  
25-222-170  
17 cm, 6 3/4"

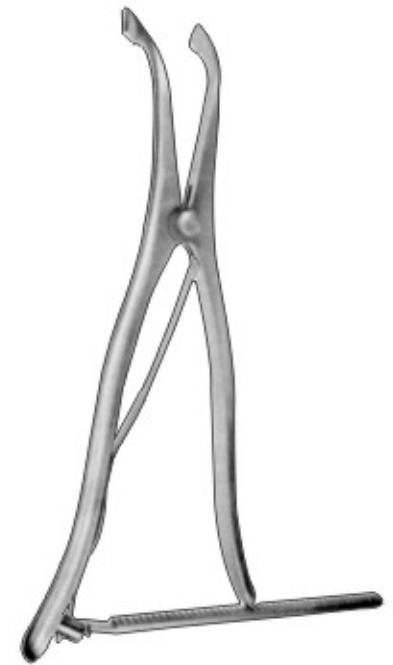

**INGE**, 26 cm, 10 1/4"  
25-223-260 Jaw width 5 mm  
25-224-260 Jaw width 10 mm  
large pattern



**CLOWARD**  
25-225-130  
13 cm, 5"

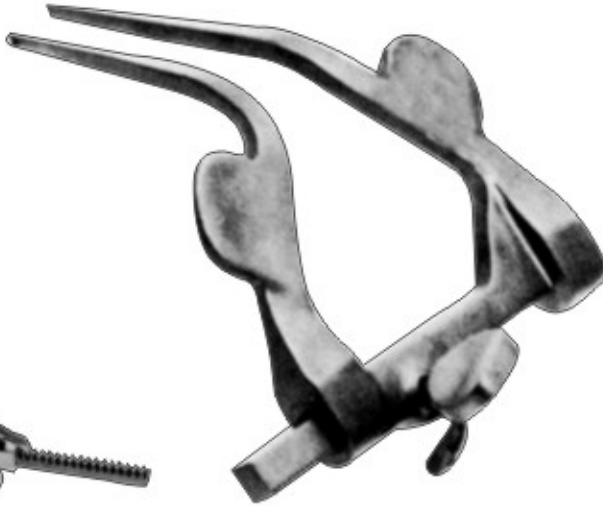

**LUMBAR LAMINA SPREADER**  
25-226-00  
arm length: 87.5 mm  
spread: 37.5 mm



**CLOWARD**  
25-227-160  
16 cm, 6 1/2"



25-228-140  
14 cm, 5 1/2"





# ORTHOPAEDICS

---

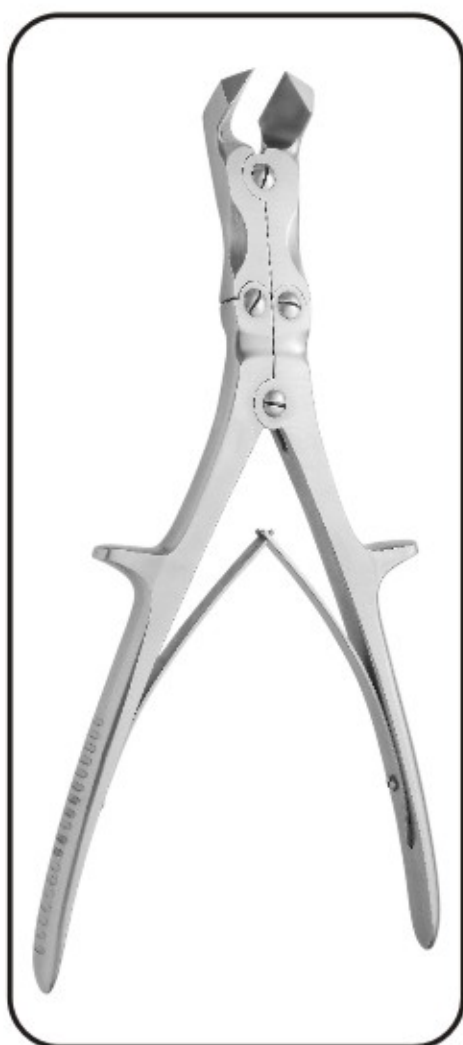
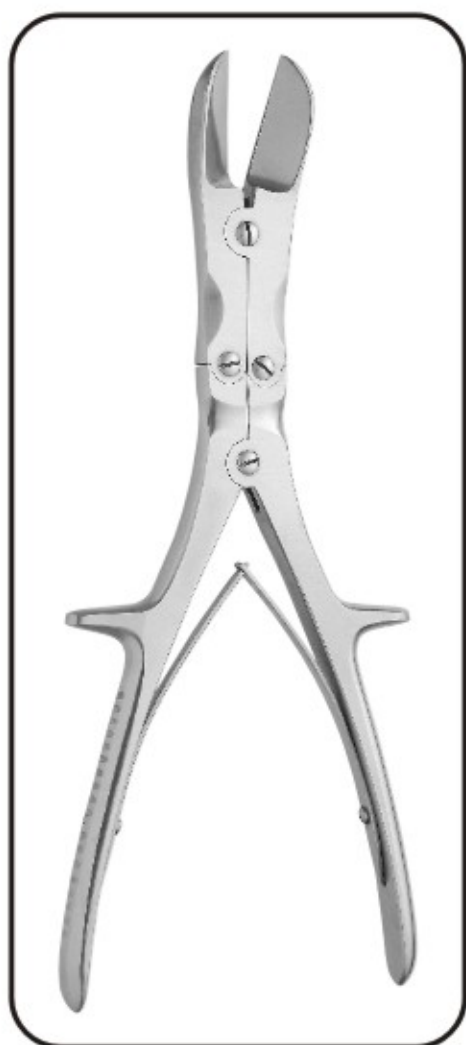



## DRILL BITS / TAPS / COUNTERSINKS



### DRILL BITS

Size	Round Shaft	AO Coupling	Dental Coupling
1.1 mm	26-001-11	26-012-11	26-023-11
1.5 mm	26-002-15	26-013-15	26-024-15
2.0 mm	26-003-20	26-014-20	26-025-20
2.5 mm	26-004-25	26-015-25	26-026-25
2.7 mm	26-005-27	26-016-27	26-027-27
3.2 mm	26-006-32	26-017-32	26-028-32
3.2 mm(long)	26-007-32L	26-018-32L	26-029-32L
3.5 mm	26-008-35	26-019-35	26-030-35
3.5 mm(long)	26-009-35L	26-020-35L	26-031-35L
4.5 mm	26-010-45	26-021-45	26-032-45
4.5 mm(long)	26-011-45L	26-022-45L	26-033-45L



### TAPS

Size	T-Handle	AO Coupling	Dental Coupling
1.5 mm			26-048-15
2.0 mm			26-049-20
2.7 mm	26-034-27	26-041-27	
3.5 mm(cortical)	26-035-35	26-042-35	
3.5 mm(cancellous)	26-036-35D	26-043-35D	
4.0 mm	26-037-40	26-044-40	
4.5 mm(short thread)	26-038-45	26-045-45	
4.5 mm(long thread)	26-039-45D	26-046-45D	
6.5 mm	26-040-65	26-047-65	



**MINI COUNTERSINK**  
26-050-15  
1.5 mm Screws  
2.00 mm Diam Tip 1.1 mm



**SMALL COUNTERSINK**  
26-051-27  
2.7, 3.5 mm and  
4.0 mm Screws Tip 2.0 mm



**MALLEOLAR COUNTERSINK**  
26-052-45  
Tip 3.2 mm

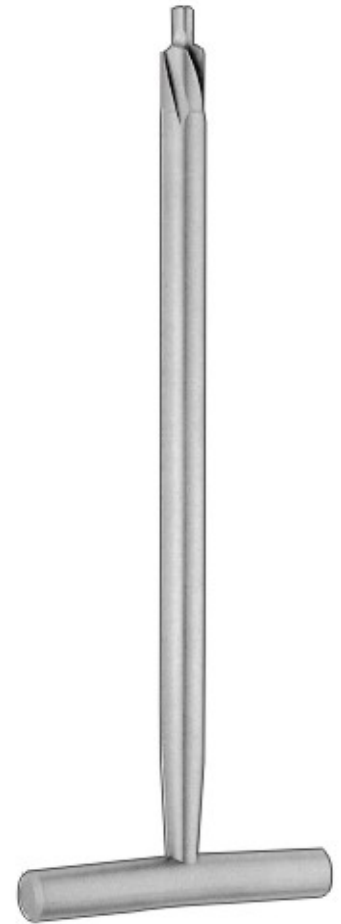

**LARGE COUNTERSINK**  
26-053-65  
4.5 mm and 6.5 diam Screws  
Tip 4.5 mm



# ORTHOPAEDICS

Orthopädie  
Ortopedia

Orthopédie  
Ortopedia

## HANDLES



**DENTAL**  
Handle Coupling  
26-054-11



**FIBER HANDLE**  
26-055-32  
AO Coupling



**T-HANDLE**  
26-056-02  
AO Coupling



**JACOB'S CHUCK**  
26-057-01 T-Handle and key  
26-058-02 only  
26-059-03 Key



**KEY HANDLE**  
26-060-15



**FIBER Key Handle**  
26-061-180  
18cm, 7"



**BONE DRILLS**



**RALK**  
**26-062-03**  
Hand Drill light metal case and laterally angled handle, with 3 - jaw chuck and key, opening up to 6.35 mm diameter

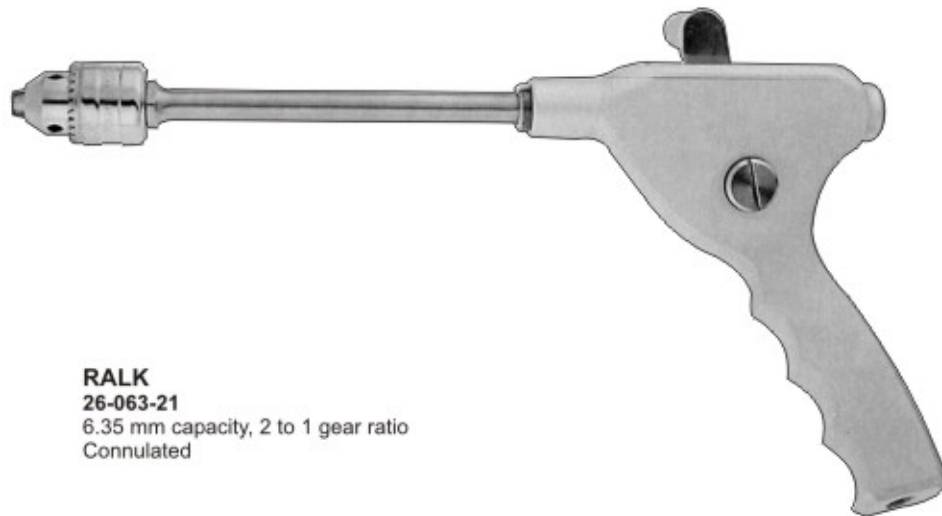

**RALK**  
**26-063-21**  
6.35 mm capacity, 2 to 1 gear ratio  
Conulated



## BONE DRILLS



**HUDSON**  
26-064-000



**Fig. 1**  
26-065-01



**Fig. 2**  
26-066-02



**Fig. 3**  
26-067-03



**CUSHING**  
26-068-07



26-069-13



## SCREW DRIVERS



**SCREW DRIVER**  
26-070-20  
single head



**SCREW DRIVER**  
26-071-48  
philips head



**SCREW DRIVER**  
26-072-10  
slotted head



**WILLIAMS**  
Screw Driver



**26-073-06**  
Phillips Head



**26-074-06**  
Slotted Head



**26-075-06**  
Single Head



**26-076-06**  
Hexagonal Head  
3.5 mm



### HEXAGONAL HEAD

Size of screws	Head Size	Fiber-Handle	AO Coupling	Dental Coupling
1.5mm	1.5mm	<b>26-077-15</b>	<b>26-080-15</b>	<b>26-083-15</b>
2.0mm				
2.7mm	2.5mm	<b>26-078-25</b>	<b>26-081-25</b>	
3.5mm				
4.0mm				
4.5mm	3.5mm	<b>26-079-35</b>	<b>26-082-35</b>	
6.5mm				



**HOLDING SLEEVE**  
26-084-15  
1.5 mm



**HOLDING SLEEVE**  
26-085-25  
2.5 mm



## INSTRUMENTS FOR PLATING



### DEPTH GAUGE

**26-086-15**  
1.5 mm & 2.0 mm screws  
**26-087-27**  
2.7 mm & 4.0 mm screws  
**26-088-45**  
4.5 mm & 6.5 mm screws



### SCREW FORCEPS

**26-089-001**



### SHARP HOOK

**26-090-001**



### BENDING TEMPLATE

Size	3.5 mm	4.5 mm
5 hole		<b>26-093-05</b>
7 hole	<b>26-091-07</b>	<b>26-094-07</b>
9 hole	<b>26-092-09</b>	<b>26-095-09</b>



### COMBINATION Wrench

**26-096-11**  
width across flats 11 mm

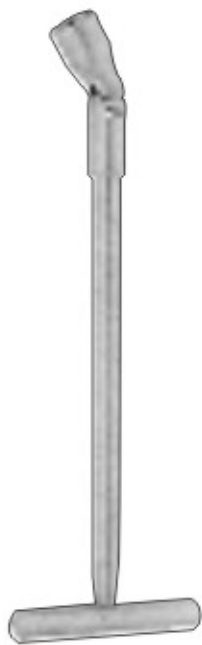

### SOCKET WRENCH

**26-097-11**  
width across flats 11 mm



### COMPRESSION Device

**26-098-08**  
8 mm screw-type

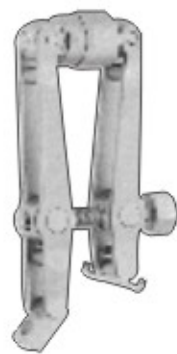

### ARTICULATED Tension Device

**26-099-20**  
with Indicator span 20 mm may also be used for distraction of standard and small plates



### PIN WRENCH

**26-100-02**  
Tension Device & Distactor



### DRILL SLEEVE

**26-101-07**  
Tension Device

**PLATE BENDING INSTRUMENTS**

**BENDING IRON**  
26-102-01  
Mini Plates



**BENDING IRONS**  
26-103-02  
small plates to be  
used as a pair



**BENDING IRONS**  
26-104-03  
small plates to  
be used as a pair

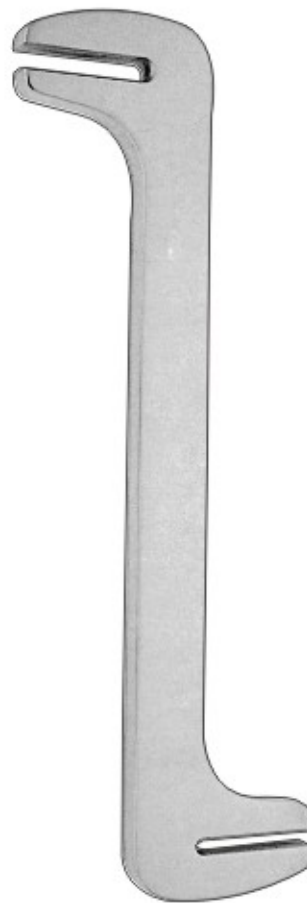

**BENDING IRON**  
26-105-04  
Standard Plates Beak  
opening 4 and 6 mm



**BENDING PLIERS**  
26-106-15  
1.5 and 2.0 mm Plates





# ORTHOPAEDICS

Orthopädie  
Ortopedia

Orthopédie  
Ortopedia

## DRILL SLEEVES



### MINI DRILL SLEEVE

26-107-11

1.1 mm and 1.5 mm drill bits

26-108-15

1.5 mm and 2.0 mm drill bits



### DRILL GUIDE

26-109-20

drill sleeve for 2.0 mm  
drill bit



26-110-27

Tap Sleeve, 2.0 mm  $\phi$

Drill Sleeve, 2.7 mm  $\phi$

26-111-35

Tap Sleeve, 2.5 mm  $\phi$

Drill Sleeve, 3.5 mm  $\phi$

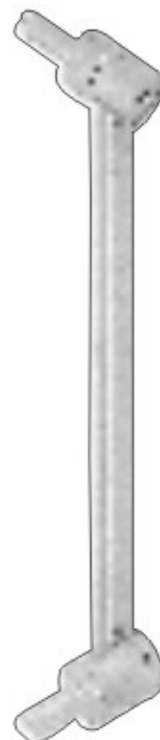

### NEUTRAL & LOAD DRILL GUIDE

26-112-20 1.5 mm for 2.0 mm Screws

26-113-27 2.0 mm for 2.7 mm Screws

26-114-35 2.5 mm for 3.5 mm Screws

26-115-45 3.2 mm for 4.5 mm Screws



### TAP SLEEVE

26-116-35

3.5 mm also for used  
as 3.2 mm drill Guide



### TAP SLEEVE

26-117-45

4.5 mm



### DRILL SLEEVE

26-118-32

3.2 mm for Round  
Hole Plates



**DRILL SLEEVES**



**INSERT DRILL SLEEVE**

- 26-119-27** 2.7 / 2.0 mm Drill Bit 2.0 mm
- 26-120-35** 3.5 / 2.5 mm Drill Bit 2.5 mm
- 26-121-45** 4.5 / 3.2 mm Drill Bit 3.2 mm



**DRILL Small Pointed**

- 26-122-35**
- Drill Bit 3.5 mm



**DRILL Pointed Guide**

- 26-123-58**
- 6.5 mm

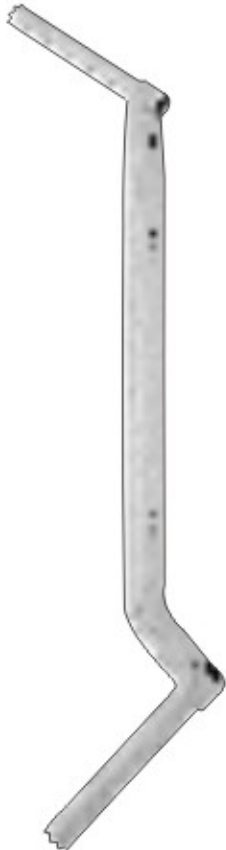

**DRILL GUIDE**

- 26-124-08**
- 4.5 mm Screws
- Drill Bit 4.5 mm & 3.2 mm

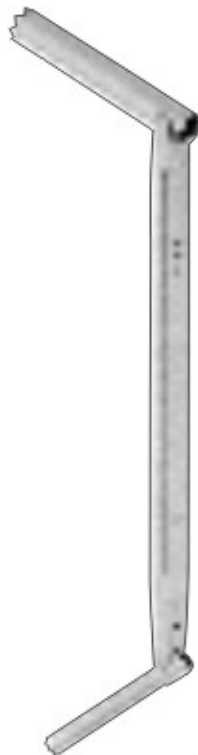

**DRILL GUIDE**

- 26-125-65**
- 6.5 mm Screws
- Drill Bit 3.2 mm



**DRILL GUIDE**

- 26-126-02**
- 3.5 mm for neutral and compression Positioning
- Drill Bit 2.5 mm



**C - CLAMP**

- 26-127-45**
- Drill Guide with thread for Drill Bit 4.5 mm



# BONE HOLDING FORCEPS, REPOSITION FORCEPS

Knochenfazzange, Repositionszangen  
Pinzas para hueso, Pinzas para reposición

Daviers porte-os, Pincas à réduction  
Tenaglie per ossa, Pinze per riposizioni

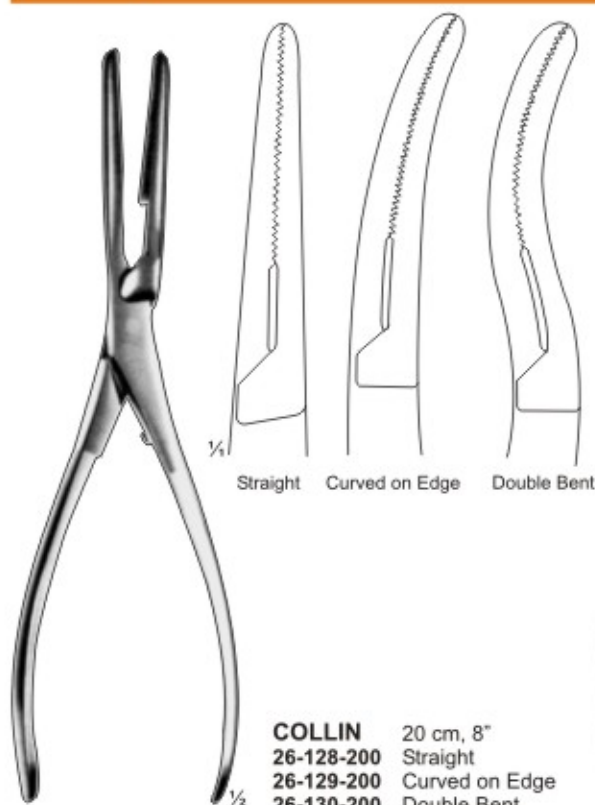

**COLLIN** 20 cm, 8"  
26-128-200 Straight  
26-129-200 Curved on Edge  
26-130-200 Double Bent

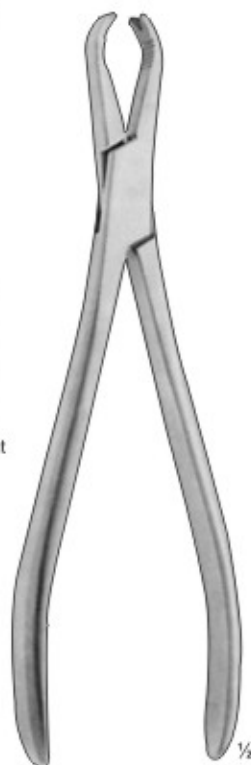

**26-131-200**  
20 cm, 8"

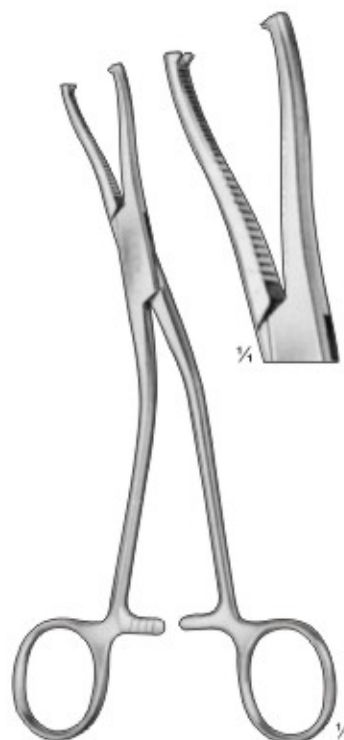

**DINGMANN**  
26-132-180  
18 cm, 7"



**FERGUSON**  
26-133-230  
23 cm, 9"



**COLLIN**  
26-134-190  
19 cm, 7 1/2"  
Lion Jaw



**COLLIN**  
26-135-195  
19.5 cm, 8"  
Toothed Jaw



**BARDELEBEN**  
26-136-210  
21 cm, 8 1/2"



**FERGUSON**  
26-137-210  
21 cm, 8 1/2"

# BONE HOLDING FORCEPS, REPOSITION FORCEPS

Knochenfasszange, Repositionszangen  
Pinzas para hueso, Pinzas para reposición

Daviers porte-so, Pince à réduction  
Tenaglie per ossa, Pinze per riposizioni



**SELF-CENTERING  
BONE HOLDING FORCEPS**  
with Thread Lock

- 26-138-150**  
For small Fragments 15 cm, 6" jaw 9 mm
- 26-139-190**  
19 cm, 7 1/2" Extra small jaw 10 mm
- 26-140-240**  
24 cm, 9 1/2" small jaw 14 mm
- 26-141-260**  
26 cm, 10" medium jaw 18 mm
- 26-142-280**  
28 cm, 11" large jaw 23 mm



**ULRICH**  
**26-143-190** 19 cm, 7 1/2"  
**26-144-230** 23 cm, 9"  
**26-145-250** 25 cm, 10"  
**26-146-280** 28 cm, 11"



**SEMB**  
**26-147-190**  
19 cm, 7 1/2"



**26-148-000**  
Set includes:  
Hooked Jaws: 1 pair  
Serrated Jaws: 3 pairs  
Sizes: 32, 51 and 57 mm



**CHARNLEY  
BONE FORCEPS**  
**26-149-000**



## BONE HOLDING FORCEPS, REPOSITION FORCEPS

Knochenfasszange, Repositionszangen  
Pinzas para hueso, Pinzas para reposición

Daviers porte-so, Pincas à réduction  
Tenaglie per ossa, Pinze per riposizioni



**LANE**  
26-150-330 23 cm, 9"  
26-151-470 33 cm, 13"



**LANE**  
26-152-330 23 cm, 9"  
26-153-470 33 cm, 13"



**KERN**  
26-154-160 16 cm, 6 1/2" with ratchet  
26-155-210 21 cm, 8 1/2" with ratchet  
26-156-160 16 cm, 6 1/2" without ratchet  
26-157-210 21 cm, 8 1/2" without ratchet



**FARABEU-F-LAMBOTTE**  
26-158-230 23 cm, 9" with ratchet  
26-159-260 26 cm, 10 1/4" with ratchet  
26-160-230 23 cm, 9" without ratchet  
26-161-260 26 cm, 10 1/4" without ratchet



**LAMBOTTE**  
26-162-265  
26.5 cm, 10 1/2"



**LAMBOTTE**  
26-163-220 22 cm, 9"  
26-164-270 27 cm, 10 1/2"  
26-165-330 33 cm, 13"



**HEY GROVES**  
26-166-210 21 cm, 8 1/2"  
26-167-270 27 cm, 10 1/2"  
26-168-300 30 cm, 12"



**ULRICH**  
26-169-260  
26 cm, 10"

# BONE HOLDING FORCEPS, REPOSITION FORCEPS

Knochenfasszange, Repositionszangen  
Pinzas para hueso, Pinzas para reposición

Daviers porte-so, Pince à réduction  
Tenaglie per ossa, Pinze per riposizioni



**LOWMANN BONE CLAMP**

26-170-130 18.0 cm, 7"  
26-171-185 20.0 cm, 8"  
26-172-300 22.0 cm, 8 3/4"



**LOWMAN-HOGLUND**

26-173-175  
17.5 cm, 7"

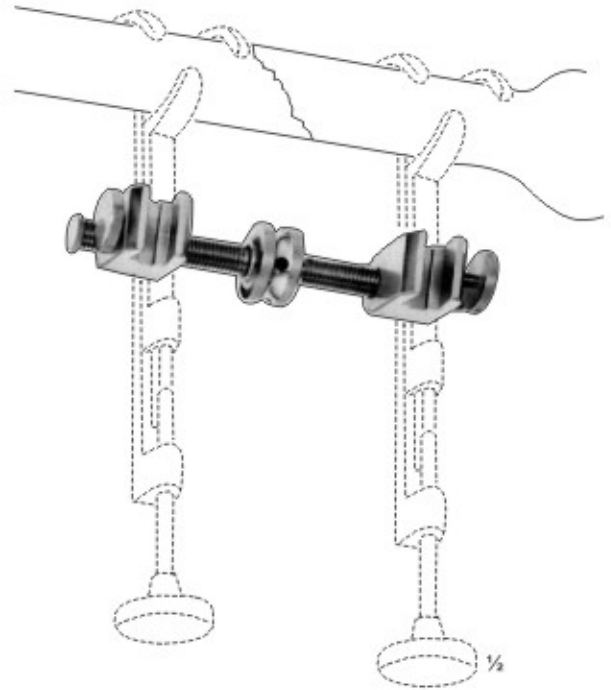

**GERSTER**

26-174-180 18 cm, 7"  
26-175-200 20 cm, 8"  
26-176-220 22 cm, 9"



**LEWIN**

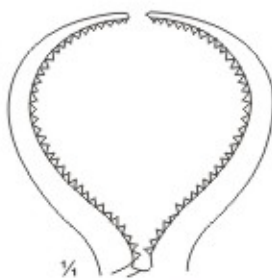

26-177-175  
17.5cm, 7"



**ORTHO FORCEPS**

26-178-130  
13 cm, 5"

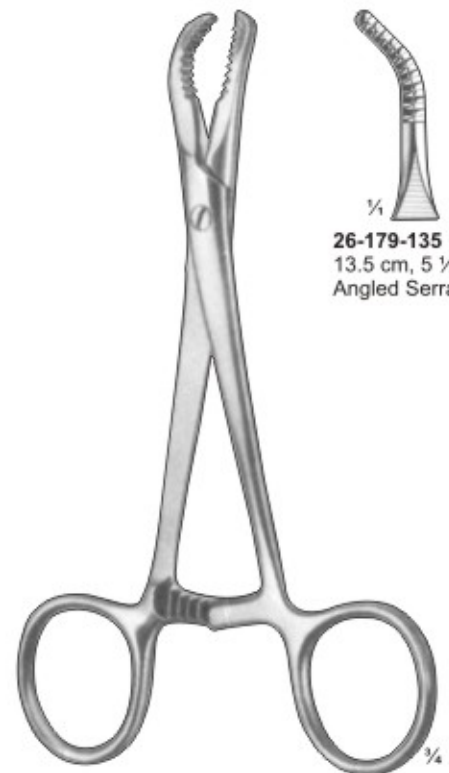

**ORTHO FORCEPS**

26-179-135  
13.5 cm, 5 1/2"  
Angled Serrated



## BONE HOLDING FORCEPS

Knochenfazzange  
Pinzas para hueso

Daviers porte-so  
Tenaglie per ossa



**VERBRUGGE**  
26-180-180  
18 cm, 7"

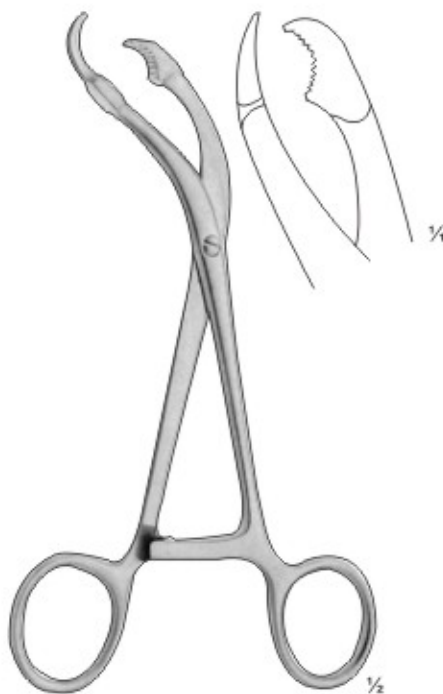

**VERBRUGGE**  
26-181-180  
18 cm, 7"



**VERBRUGGE**  
26-182-250 25 cm, 10"  
26-183-260 26 cm, 10 1/4"  
26-184-270 27 cm, 10 1/2"

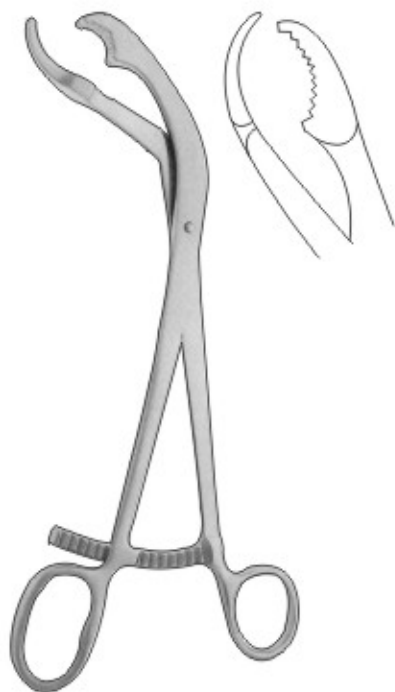

**VERBRUGGE**  
26-185-250 25 cm, 10"  
26-186-260 26 cm, 10 1/4"  
26-187-270 27 cm, 10 1/2"



**VERBRUGGE**  
26-188-180  
18 cm, 7"



**VERBRUGGE**  
26-189-250 25 cm, 10"  
26-190-260 26 cm, 10 1/4"  
26-191-270 27 cm, 10 1/2"

# BONE HOLDING FORCEPS, REPOSITION FORCEPS

Knochenfasszange, Repositionszangen  
Pinzas para hueso, Pinzas para reposición

Daviers porte-so, Pincas à réduction  
Tenaglie per ossa, Pinze per riposizioni



**REIL**  
26-192-170  
17 cm, 7"

**REDUCTION FORCEPS**  
26-193-200  
20 cm, 8"  
with Points

**26-194-170**  
17 cm, 7"  
For fingers, with drill  
Guide for Kirschner  
Wires up to 1 mm

**HOLDING FORCEPS**  
26-195-130  
13 cm, 5"



**RATCHET FIXATION  
FORCEPS**  
26-196-145  
14.5 cm, 6"

**MALLEOLAR  
FORCEPS**  
26-197-200  
20 cm, 8"

**PATELLA  
FORCEPS**  
26-198-185  
18.5 cm, 7 1/2"

**REDUCTION FORCEPS**  
26-199-160 16 cm, 6 1/2"  
26-200-240 24 cm, 9 1/2"  
with Thread Lock

**REPOSITION  
FORCEPS**  
26-201-230  
23 cm, 9"





## PELVIC REPOSITION FORCEPS

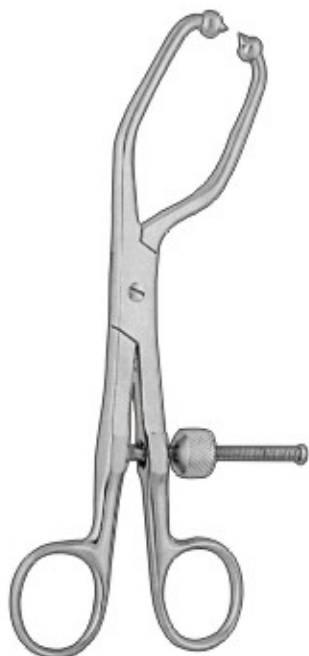

**PELVIC REPOSITION FORCEPS**  
26-202-19  
19 cm, 7 1/2"

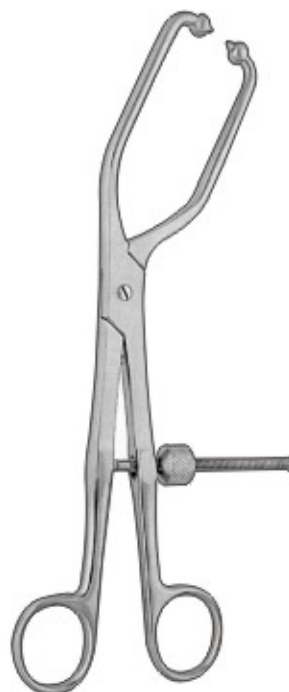

**PELVIC REPOSITION FORCEPS**  
26-203-23  
23 cm, 9"

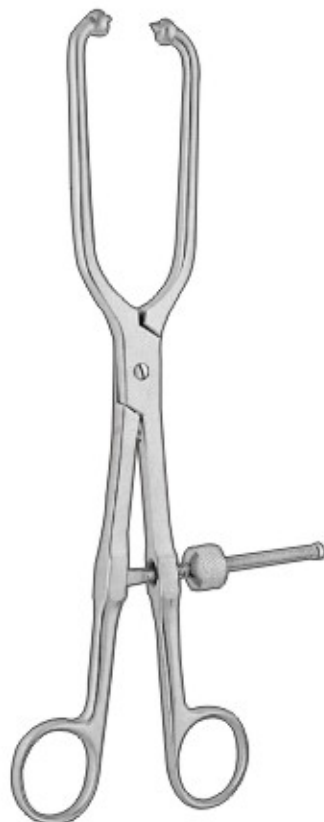

**PELVIC REPOSITION FORCEPS**  
26-204-25  
25 cm, 10"



**PELVIC REPOSITION FORCEPS**  
26-205-25 25 cm, 10"  
3 Balls Spikes



**PELVIC REDUCTION FORCEPS**

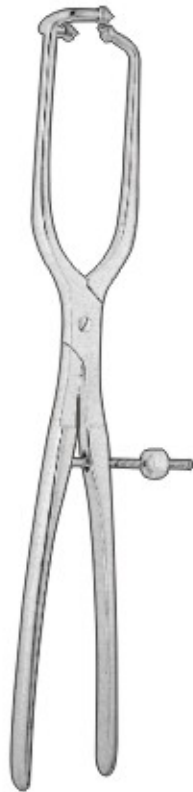

**PELVIC REPOSITION  
FORCEPS**  
26-206-400  
40 cm, 15 3/4"

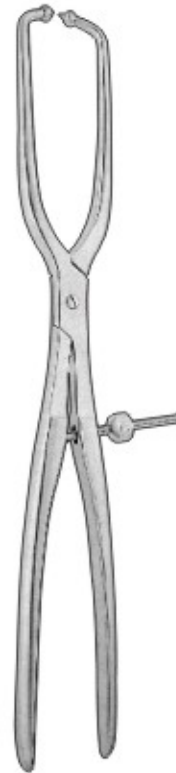

**PELVIC REPOSITION  
FORCEPS**  
26-207-400  
40 cm, 15 3/4"



**PELVIC REDUCTION  
FORCEPS ASYMMETRIC**  
26-208-250  
25 cm, 10"  
with 3 ball Spikes



**PELVIC REDUCTION  
FORCEPS ASYMMETRIC**  
26-209-250  
25 cm, 10"



**PELVIC REDUCTION  
FORCEPS ASYMMETRIC**  
26-210-400  
40 cm, 15 3/4"



## PELVIC INSTRUMENTS



**SHARP BONE HOOK**  
26-211-04



**TAP HANDLE**  
26-212-01  
for Jacobs Chuck



**PELVIC REPOSITION FORCEPS**  
19 cm, 7 1/2"  
26-213-35 3,5 mm for Screws  
26-214-45 4,5 mm for Screws

# AMPUTATION SAW



Amputationssägen  
Sierras de amputación

Scies à amputation  
Seghe per amputazione



**GIGLI SAW**

26-215-030 30 mm  
26-216-040 40 mm  
26-217-050 50 mm  
26-218-070 70 mm  
stainless



**GIGLI HANDLE**  
26-219-000



**ENGEL  
PLASTER SAW**  
26-220-155  
15.5 cm, 6"



**CHARRIERE**  
26-221-250 25 cm, 10"  
26-222-270 27 cm, 10 3/4"  
Double saw



**CHARRIERE**  
26-223-270 27 cm, 10 3/4"  
26-224-300 30 cm, 12"



**CHARRIERE**  
26-225-350  
35 cm, 13 3/4"



**SATTERLEE**  
26-226-310  
31cm, 12 1/4"

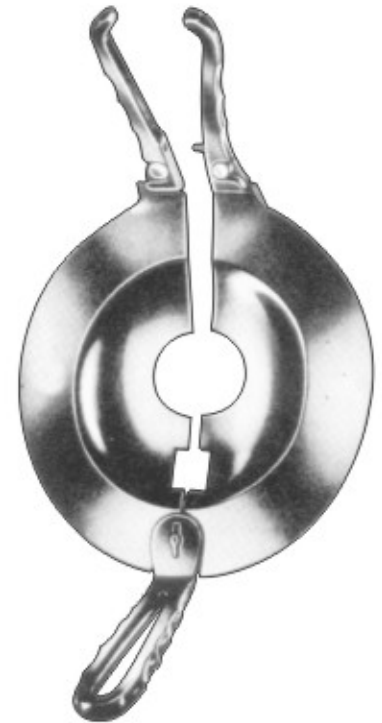

**PERCY RETRACTOR**  
26-227-000



# MALLETS

Hämmer  
Martillos

Maillets  
Martelli



plane (nylon)  
convex (steel)  
plastic handle  
Head 30mm Ø  
Weight 675 Gr.

1/4

## MALLET

26-228-265  
26 cm, 10 1/2"



plastic handle  
Head 42 / 30mm Ø  
Weight 530 Gr.

1/4

## MALLET

26-229-260  
26 cm, 10 1/4"



plastic handle  
Head 30mm Ø  
Weight 480 Gr.

1/4

## MALLET

26-230-240  
24 cm, 9 1/2"



Plastic Handle  
Head 30mm Ø  
Weight 510 Gr.

1/4

## MALLET

26-231-260  
26 cm, 10 1/4"



Spare Facing (pair)  
Pi09-448-00  
Plastic

disks and plastic handle  
Head 37mm Ø  
Weight 370 Gr.

1/4

## MALLET

26-232-240  
22.5 cm, 9"



made of plastic  
Head 30mm Ø  
Weight 125 Gr.

1/4

## MALLET

26-233-220  
18 cm, 7"



made of plastic  
with lead filling  
Head 42mm Ø  
Weight 400 Gr.  
Head 42mm Ø  
Weight 250 Gr.

1/4

## MALLET

26-234-260  
26 cm, 10 1/4"



made of plastic  
with lead filling  
Head 42mm Ø  
Weight 250 Gr.

1/4

## MALLET

26-235-260  
26 cm, 10 1/4"

# MALLETS



Hämmer  
Martillos

Maillets  
Martelli



**WILLIGER**  
26-236-155  
24 cm, 9 1/2"

**26-237-155**  
Head 26 mm Ø  
Weight 300 Gr.  
**26-238-155**  
Head 28 mm Ø  
Weight 340 Gr.  
**26-239-155**  
Head 30 mm Ø  
Weight 400 Gr.



**DOYEN**  
26-240-205  
21 cm, 8 1/4"

**26-241-205**  
Head 25 mm Ø  
Weight 120 Gr.  
**26-242-205**  
Head 30 mm Ø  
Weight 180 Gr.  
**26-243-205**  
Head 35 mm Ø  
Weight 260 Gr.

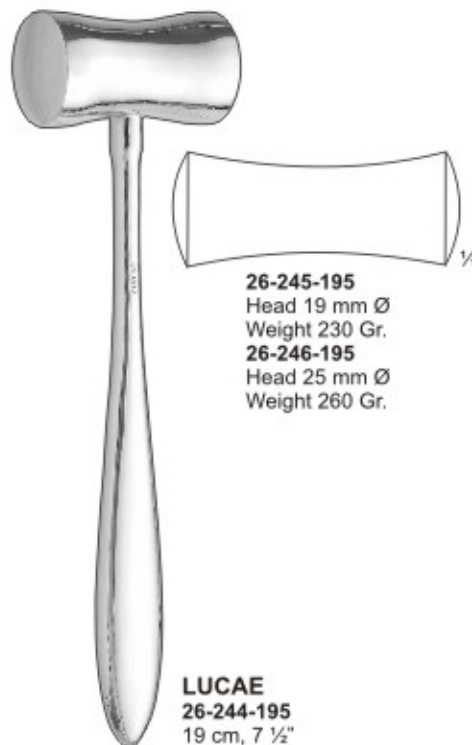

**LUCAE**  
26-244-195  
19 cm, 7 1/2"

**26-245-195**  
Head 19 mm Ø  
Weight 230 Gr.  
**26-246-195**  
Head 25 mm Ø  
Weight 260 Gr.

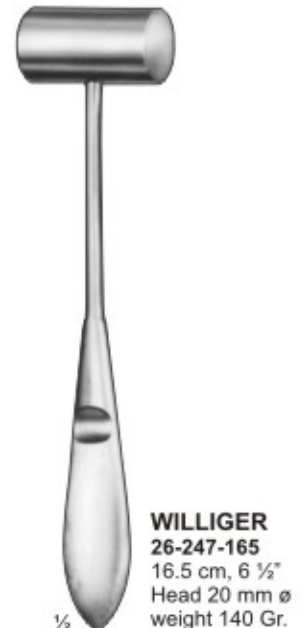

**WILLIGER**  
26-247-165  
16.5 cm, 6 1/2"  
Head 20 mm Ø  
Weight 140 Gr.



**PARTSCH**  
26-248-190  
18 cm, 7"

Head 22mm Ø  
Weight 200 Gr.



**MEAD**  
26-249-190  
17 cm, 6 3/4"

**26-250-190**  
with interchangeable  
Plastic dicks  
Head 26 mm Ø  
Weight 320 Gr.

Spare Facings  
26-251-190



**HERBERT**  
26-252-190  
19 cm, 7 1/2"

for ulnar head  
prosthesis  
plastic handle  
Head 25mm Ø  
Weight 300 Gr.



**VICKERS**  
26-253-265  
19 cm, 7 3/4"

nylon disks  
plastic handle  
Head 25mm Ø  
Weight 300 Gr.



## MALLETS

Hämmer  
Martillos

Maillets  
Martelli

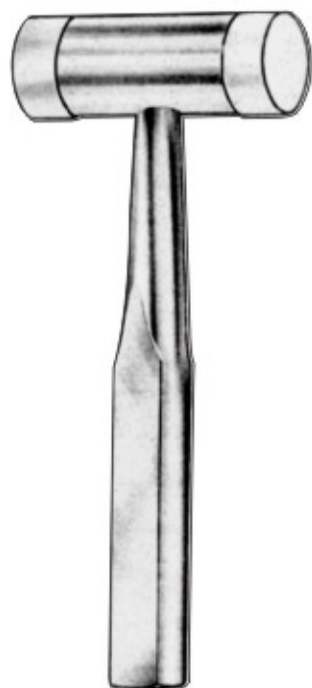

**ORTHO / WITH PLASTIC CAPS**  
26-254-180  
18 cm, 7"  
25 mm Dia.  
(140g)  
Pair of spare disks  
with interchangeable  
plastic disks



$\frac{1}{2}$   
**ORTHO**  
26-255-265  
26.5 cm, 10  $\frac{1}{2}$ "  
(450g)



$\frac{1}{2}$   
**ORTHO PAEDIC  
Mallet**  
26-256-190  
19 cm, 7  $\frac{1}{2}$ "



$\frac{1}{2}$   
**HAJEK**  
26-257-223  
22 cm, 8  $\frac{1}{4}$ "  
27 mm Dia.  
(140g)



$\frac{1}{2}$   
**ORTHO**  
26-258-265  
26.5 cm  
(450g)



$\frac{1}{2}$   
**BERGMANN**  
26-259-240  
24 cm, 9  $\frac{1}{2}$ "  
(300g)



$\frac{1}{2}$   
**GERZOG**  
26-260-180  
18 cm, 7"  
(240g)



$\frac{1}{2}$   
**OMBREDANNE**  
26-261-240  
24 cm, 9  $\frac{1}{2}$ "  
40 mm dia (550g)



$\frac{1}{2}$   
**COTTLE**  
26-262-190  
19 cm, 7  $\frac{1}{2}$ "  
(240g)



$\frac{1}{2}$   
**COLLIN**  
26-263-200  
20 cm, 8"  
30 mm dia  
220 g

# BONE CURETTES



Scharfe Löffel  
Cucharillas cortantes

Curettes tranchantes  
Curette taglienti

**26-264-170**  
17 cm, 7"  
000  
**26-265-170**  
17 cm, 7"  
00  
**26-266-170**  
17 cm, 7"  
0  
**26-267-170**  
17 cm, 7"  
1  
**26-268-170**  
17 cm, 7"  
2  
**26-269-170**  
17 cm, 7"  
3  
**26-270-170**  
17 cm, 7"  
4  
**26-271-170**  
17 cm, 7"  
5  
**26-272-170**  
17 cm, 7"  
6

**BRUNS**

**26-273-225**  
22.5 cm, 9"  
000  
**26-274-225**  
22.5 cm, 9"  
00  
**26-275-225**  
22.5 cm, 9"  
0  
**26-276-225**  
22.5 cm, 9"  
1  
**26-277-225**  
22.5 cm, 9"  
2  
**26-278-225**  
22.5 cm, 9"  
3  
**26-279-225**  
22.5 cm, 9"  
4  
**26-280-225**  
22.5 cm, 9"  
5  
**26-281-225**  
22.5 cm, 9"  
6

**HIBBS-SPRATT /  
ANGLED**

**26-282-225**  
22.5 cm, 9"  
000  
**26-283-225**  
22.5 cm, 9"  
00  
**26-284-225**  
22.5 cm, 9"  
0  
**26-285-225**  
22.5 cm, 9"  
1  
**26-286-225**  
22.5 cm, 9"  
2  
**26-287-225**  
22.5 cm, 9"  
3  
**26-288-225**  
22.5 cm, 9"  
4  
**26-289-225**  
22.5 cm, 9"  
5  
**26-290-225**  
22.5 cm, 9"  
6

**HIBBS-SPRATT /  
STRAIGHT**

**26-291-133**  
13.25 cm, 5 1/2"  
Double Ended  
00/0

**WILLIGER**

**26-292-170**  
17 cm, 7"  
00000  
**26-293-170**  
17 cm, 7"  
0000  
**26-294-170**  
17 cm, 7"  
000  
**26-295-170**  
17 cm, 7"  
00  
**26-296-170**  
17 cm, 7"  
0  
**26-297-170**  
17 cm, 7"  
1  
**26-298-170**  
17 cm, 7"  
2  
**26-299-170**  
17 cm, 7"  
3  
**26-300-170**  
17 cm, 7"  
4  
**26-301-170**  
17 cm, 7"  
5

**SPRATT /  
HOLLOW HANDLE**

**26-302-170**  
17 cm, 7"  
0000  
**26-303-170**  
17 cm, 7"  
000  
**26-304-170**  
17 cm, 7"  
00  
**26-305-170**  
17 cm, 7"  
0  
**26-306-170**  
17 cm, 7"  
1  
**26-307-170**  
17 cm, 7"  
2  
**26-308-170**  
17 cm, 7"  
3  
**26-309-170**  
17 cm, 7"  
4  
**26-310-170**  
17 cm, 7"  
5  
**26-311-170**  
17 cm, 7"  
6

**VOLKMANN**

**26-312-130**  
13 cm, 5"  
Double Ended  
6.2 mm & 6.7 mm  
**26-313-160**  
16 cm, 6 1/2"  
Double Ended  
7 mm & 9 mm  
**26-314-200**  
20 cm, 8"  
Double Ended  
9.1 mm & 11.1 mm

**VOLKMANN**





# BONE CURETTES

Scharfe Löffel  
Cucharillas cortantes

Curettes tranchantes  
Curette taglianti



26-315-36 To  
26-318-60  
25 cm, 10"



**UFFENORDE Left**  
26-319-175  
17.5 cm, 7"



**UFFENORDE Right**  
26-320-175  
17.5 cm, 7"



**SIMON**  
24 cm, 9 1/2"

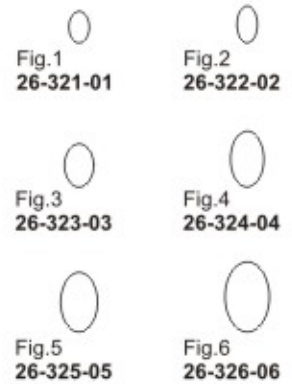

**BRUNS**  
23 mm, 9"

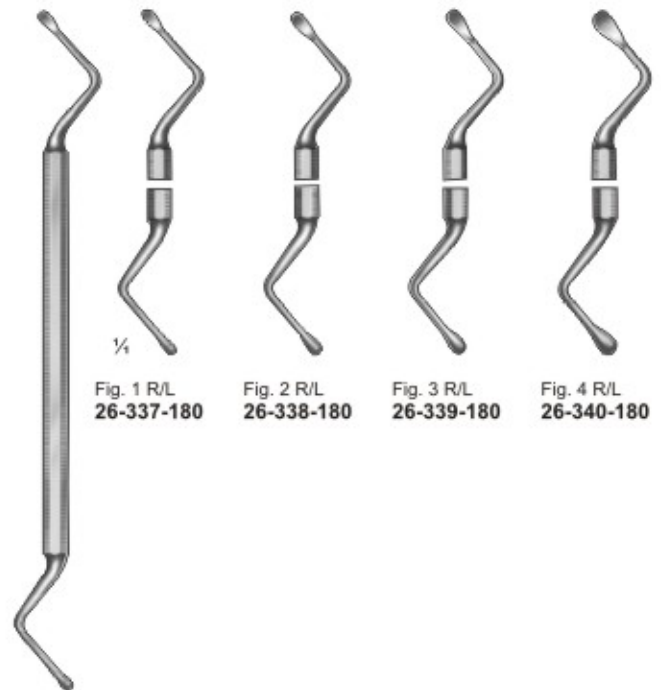
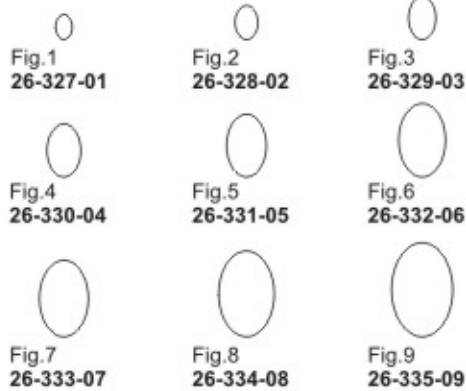

**LUCAS**  
double-ended  
26-336-180  
18 cm, 7"



# BONE CURETTES, DOUBLE-ENDED

Scharfe Doppellöffel  
Cucharillas de doble extremo

Curettes doubles  
Curette doppie



26-341-01

26-342-02

26-343-03

**WILLIGER**  
13.5 cm, 5 1/4"



26-344-01

26-345-02

26-346-03

**MARTINI**  
13.5 cm, 5 1/4"



**JANSEN**  
26-347-16  
16 cm, 6 1/4"



**JANSEN**  
26-348-16  
15 cm, 6"



26-349-21  
21 cm, 8 1/4"



**VOLKMANN**  
26-352-170  
17 cm, 6 3/4"



26-350-130  
13 cm, 5 1/4"

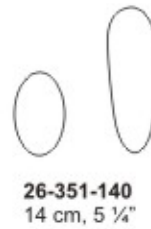

26-351-140  
14 cm, 5 1/4"



26-352-170  
17 cm, 6 3/4"



**VOLKMANN**

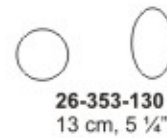

26-353-130  
13 cm, 5 1/4"

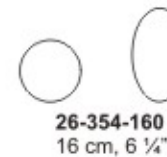

26-354-160  
16 cm, 6 1/4"

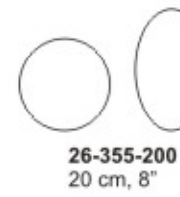

26-355-200  
20 cm, 8"



# BONE CURETTES

Scharfe Löffel  
Cucharillas cortantes

Curettes tranchantes  
Curette taglianti

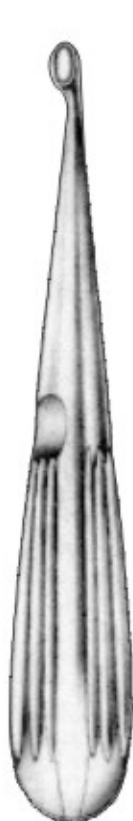

**SPRATT**

- |                             |                            |
|-----------------------------|----------------------------|
| ○<br>Fig. 0000<br>26-356-40 | ○<br>Fig. 000<br>26-357-30 |
| ○<br>Fig. 00<br>26-358-20   | ○<br>Fig. 0<br>26-359-10   |
| ○<br>Fig. 1<br>26-360-01    | ○<br>Fig. 2<br>26-361-02   |
| ○<br>Fig. 3<br>26-362-03    | ○<br>Fig. 4<br>26-363-04   |
| ○<br>Fig. 5<br>26-364-05    |                            |



**BRUNS**

- |                             |                            |                           |
|-----------------------------|----------------------------|---------------------------|
| ○<br>Fig. 0000<br>26-365-40 | ○<br>Fig. 000<br>26-366-30 | ○<br>Fig. 00<br>26-367-20 |
| ○<br>Fig. 0<br>26-368-10    | ○<br>Fig. 1<br>26-369-01   | ○<br>Fig. 2<br>26-370-02  |
| ○<br>Fig. 3<br>26-371-03    | ○<br>Fig. 4<br>26-372-04   | ○<br>Fig. 5<br>26-373-05  |
|                             |                            | ○<br>Fig. 6<br>26-374-06  |



**SCOVILLE**  
25 cm, 10"

- |  |                         |
|--|-------------------------|
|  | 26-375-000<br>Straight  |
|  | 26-376-03<br>Down Angle |
|  | 26-377-04<br>Up Angle   |



**FIBER HANDLE**  
27 cm, 10 3/4"

- |  |                     |
|--|---------------------|
|  | Fig. 0<br>26-378-10 |
|  | Fig. 1<br>26-379-01 |
|  | Fig. 2<br>26-380-02 |
|  | Fig. 3<br>26-381-03 |



- BRUNS**  
27 cm, 10 3/4" straight
- |           |           |
|-----------|-----------|
| 26-382-40 | Fig. 0000 |
| 26-383-30 | Fig. 000  |
| 26-384-20 | Fig. 00   |
| 26-385-10 | Fig. 0    |
| 26-386-01 | Fig. 1    |
| 26-387-02 | Fig. 2    |
| 26-388-03 | Fig. 3    |
| 26-389-04 | Fig. 4    |
| 26-390-05 | Fig. 5    |
| 26-391-06 | Fig. 6    |



- BRUNS**  
27 cm, 10 3/4" angled
- |           |           |
|-----------|-----------|
| 26-392-40 | Fig. 0000 |
| 26-393-30 | Fig. 000  |
| 26-394-20 | Fig. 00   |
| 26-395-10 | Fig. 0    |
| 26-396-01 | Fig. 1    |
| 26-397-02 | Fig. 2    |
| 26-398-03 | Fig. 3    |
| 26-399-04 | Fig. 4    |
| 26-400-05 | Fig. 5    |
| 26-401-06 | Fig. 6    |



**SCOVILLE**  
25 cm, 10"  
Ruptured Disc Curette

- |  |  |
|--|--|
|  | 26-402-000<br>4 mm x 10 mm<br>straight   |
|  | 26-403-004<br>4 mm x 10 mm<br>up angle   |
|  | 26-404-003<br>4 mm x 10 mm<br>down angle |

# BONE CURETTES



Scharfe Löffel  
Cucharillas cortantes

Curettes tranchantes  
Curette taglienti

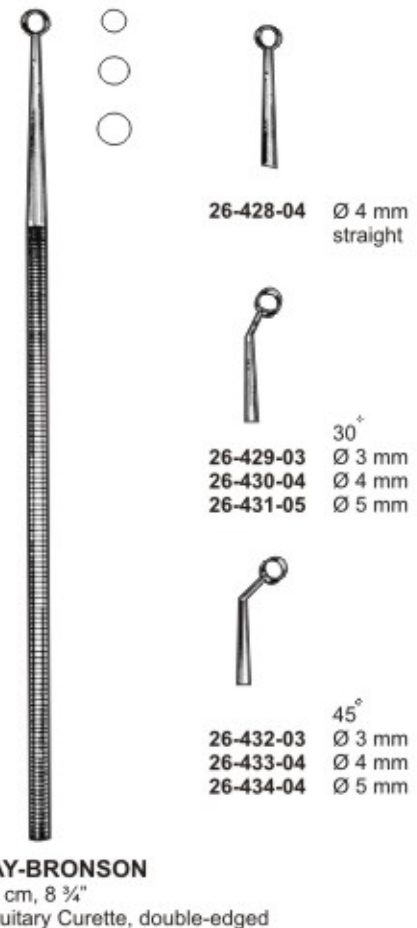
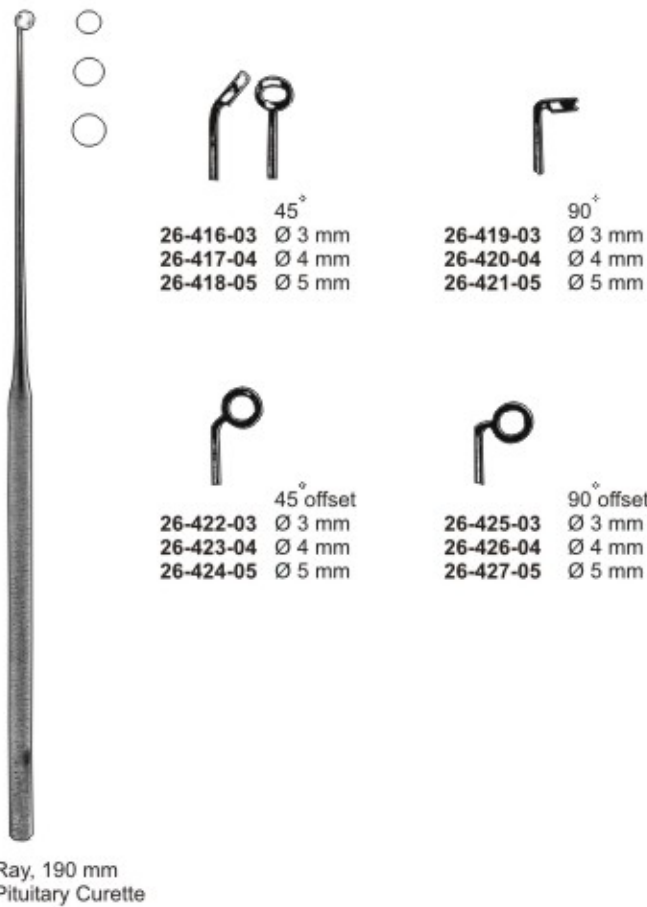
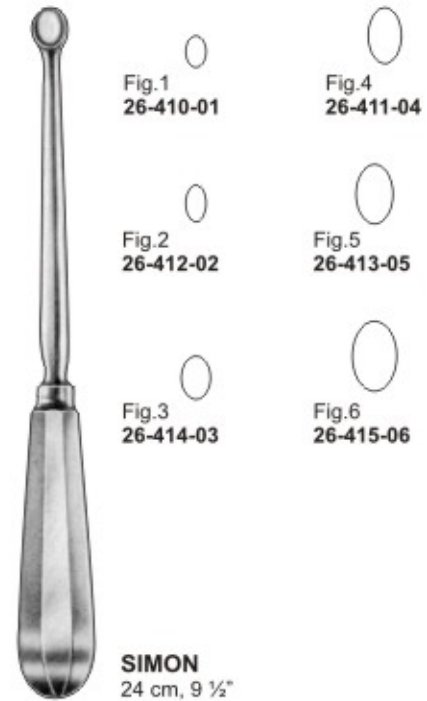
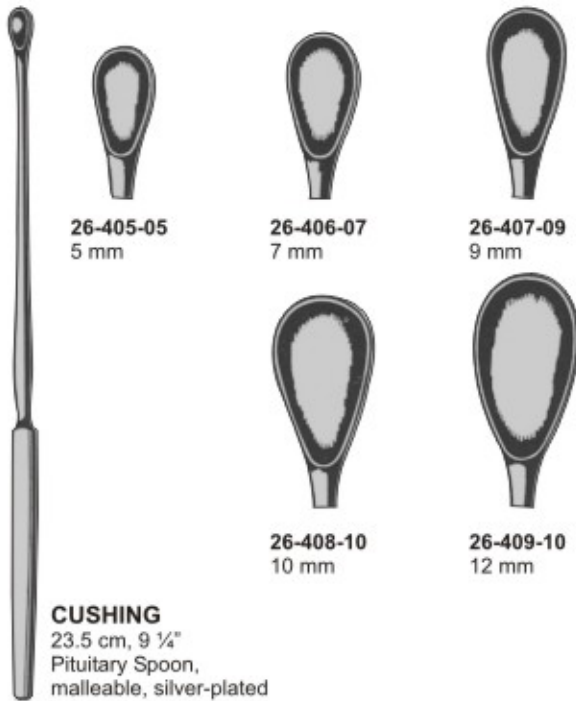



## IMPACTORS / TAMPS

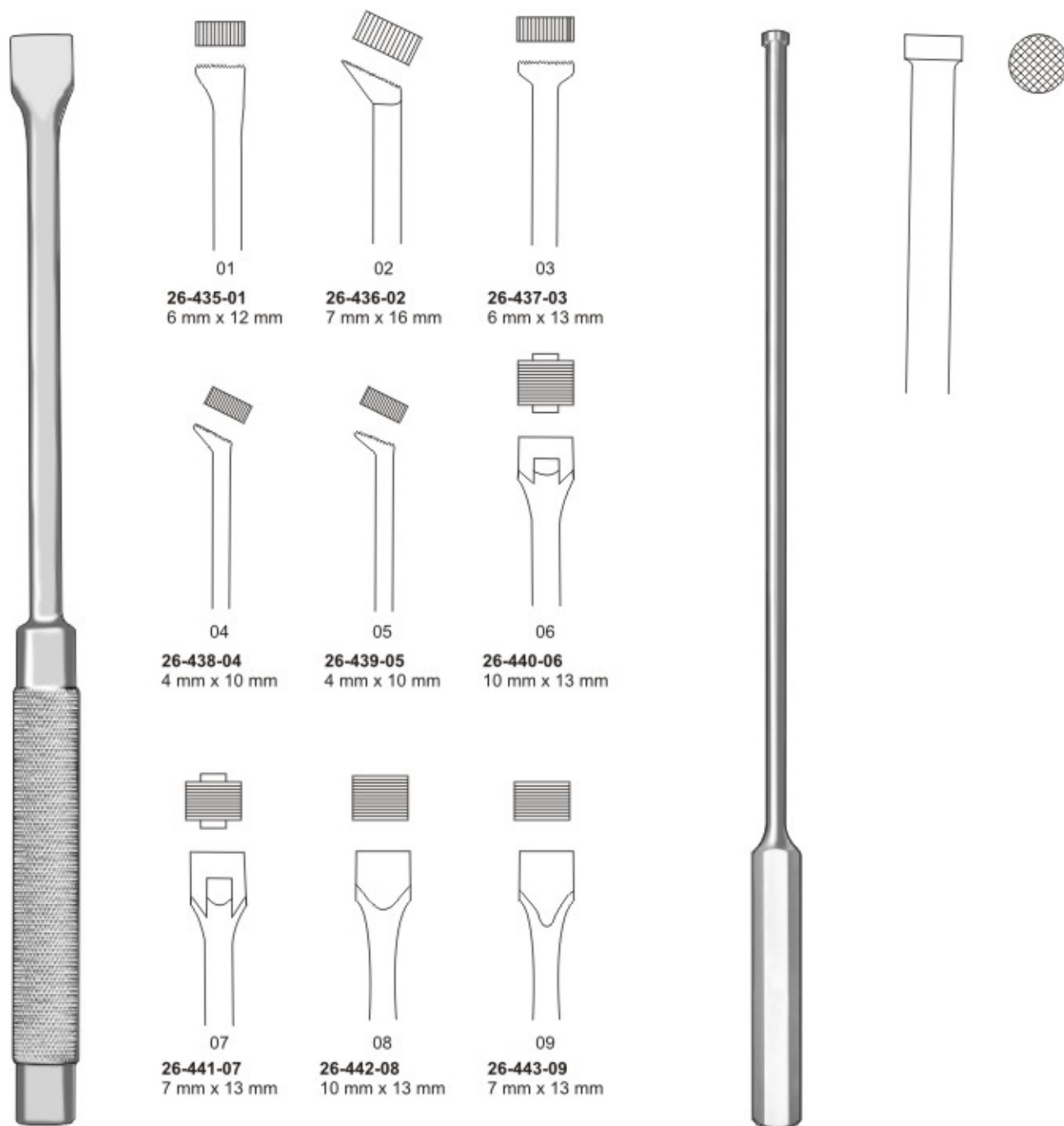

### LUMBAR, CERVICAL IMPACTORS & DRIVERS

serrated tips

<b>26-435-01</b>	Impactor, standard offset,	21.5 cm, 8 1/4"
<b>26-436-02</b>	Impactor, central canal,	21.5 cm, 8 1/4"
<b>26-437-03</b>	Impactor, lateral narrow,	21.5 cm, 8 1/4"
<b>26-438-04</b>	Impactor, micro offset,	18.0 cm, 7"
<b>26-439-05</b>	Impactor, micro lateral,	18.0 cm, 7"
<b>26-440-06</b>	Graft Driver, lumbar, guarded,	21.5 cm, 8 1/4"
<b>26-441-07</b>	Graft Driver, anterior, guarded,	21.5 cm, 8 1/4"
<b>26-442-08</b>	Graft Driver, lumbar, unguarded,	21.5 cm, 8 1/4"
<b>26-443-09</b>	Graft Driver, anterior, unguarded,	21.5 cm, 8 1/4"

### BONE TAMP ENDOSCOPIC

**26-444-10**  
43 cm, 17"  
10 mm diameter

# CHISELS / OSTEOTOMES



*Knochenmeißel, Osteotome*  
*Cinceles, Osteótomos*

*Ciseaux-burins, Ostéotomes*  
*Scalpelli, Osteotomi*



## HIBBS CHISEL

22.5 cm, 9", straight  
**26-445-06** 6 mm  
**26-446-09** 9 mm  
**26-447-12** 12 mm  
**26-448-15** 15 mm  
**26-449-18** 18 mm  
**26-450-20** 20 mm  
**26-451-25** 25 mm  
**26-452-30** 30 mm  
**26-453-35** 35 mm  
**26-454-40** 40 mm

22.5 cm, 9", curved  
**26-455-06** 6 mm  
**26-456-09** 9 mm  
**26-457-12** 12 mm  
**26-458-15** 15 mm  
**26-459-18** 18 mm  
**26-461-20** 20 mm  
**26-462-25** 25 mm  
**26-463-30** 30 mm  
**26-464-35** 35 mm  
**26-465-40** 40 mm

## OSTEOTOMES

22.5 cm, 9", straight  
**26-466-06** 6 mm  
**26-467-09** 9 mm  
**26-468-12** 12 mm  
**26-469-15** 15 mm  
**26-470-18** 18 mm  
**26-471-20** 20 mm  
**26-472-25** 25 mm  
**26-473-30** 30 mm  
**26-474-35** 35 mm  
**26-475-40** 40 mm

22.5 cm, 9", curved  
**26-476-06** 6 mm  
**26-477-09** 9 mm  
**26-478-12** 12 mm  
**26-479-15** 15 mm  
**26-480-18** 18 mm  
**26-481-20** 20 mm  
**26-482-25** 25 mm  
**26-483-30** 30 mm  
**26-484-35** 35 mm  
**26-485-40** 40 mm

HIBBS CHISEL / OSTEOTOMES



## COBB CHISEL

27.5 cm, 10 3/4", straight  
**26-486-06** 6 mm  
**26-487-09** 9 mm  
**26-488-12** 12 mm  
**26-489-15** 15 mm  
**26-490-18** 18 mm  
**26-491-25** 25 mm  
**26-492-35** 35 mm

27.5 cm, 10 3/4", curved  
**26-493-06** 6 mm  
**26-494-09** 9 mm  
**26-495-12** 12 mm  
**26-496-15** 15 mm  
**26-497-18** 18 mm  
**26-498-25** 25 mm  
**26-499-35** 35 mm

## OSTEOTOMES

275 mm straight  
**26-500-06** 6 mm  
**26-501-09** 9 mm  
**26-502-12** 12 mm  
**26-503-15** 15 mm  
**26-504-18** 18 mm  
**26-505-25** 25 mm  
**26-506-35** 35 mm

275 mm curved  
**26-507-06** 6 mm  
**26-508-09** 9 mm  
**26-509-12** 12 mm  
**26-510-15** 15 mm  
**26-511-18** 18 mm  
**26-512-25** 25 mm  
**26-513-35** 35 mm

COBB CHISEL / OSTEOTOMES



## HIBBS CHISEL endoscopic

**26-514-10**  
 46 cm, 18"  
 10 mm tip width straight

## HIBBS OSTEOTOMES endoscopic

**26-515-10**  
 46 cm, 18"  
 10 mm tip width straight



# ELEVATORS

Elevatoren  
Elevadores

Elévateurs  
Elevatori



**HARRINGTON**  
Spinal Elevator  
26-516-19 30 cm, 12"  
Sharp 19 mm tip width



**RIB ELEVATOR**, 42.5 cm, 16 3/4"  
endoscopic, Sharp with fiber  
handle 9 mm radius tip  
26-517-45 angled 45°  
26-518-90 angled 90°

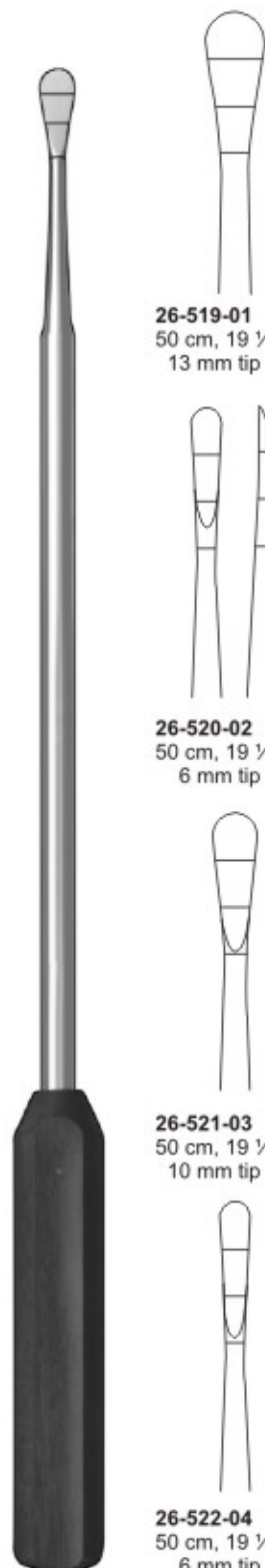

**26-519-01**  
50 cm, 19 1/2" sharp  
13 mm tip width

**26-520-02**  
50 cm, 19 1/2" sharp  
6 mm tip width

**26-521-03**  
50 cm, 19 1/2" sharp  
10 mm tip width

**26-522-04**  
50 cm, 19 1/2" sharp  
6 mm tip width

**COBB SPINAL**  
Elevator endoscopic  
with fiber handle  
graduated tips



26-523-01  
26-524-02  
26-525-03



26-526-04



26-527-05



26-528-06  
26-529-07  
26-530-08



26-531-09



26-532-10



26-533-11



26-534-12



26-535-13  
26-536-14



26-537-15



26-538-16  
26-539-17



26-540-18  
26-541-19

**RHOTON MICRO** Dissection Instruments 19 cm, 7 1/2"

- 26-523-01 Round Dissector 1 mm, angled
- 26-524-02 Round Dissector 2 mm, angled
- 26-525-03 Round Dissector 3 mm, angled
- 26-526-04 Elevator, curved
- 26-527-05 Elevator, angled
- 26-528-06 Spatula Dissector # 6 small, angled
- 26-529-07 Spatula Dissector # 7 medium, angled
- 26-530-08 Spatula Dissector # 8 large, angled
- 26-531-09 Hook, 90 angle, sharp
- 26-532-10 Hook, 90 angle, blunt
- 26-533-11 Hook, 45 angle, sharp
- 26-534-12 Needle, straight, sharp
- 26-535-13 Micro Curette, straight, 1 mm x 2 mm
- 26-536-14 Micro Curette, angled, 1 mm x 2 mm
- 26-537-15 Ball-tipped Dissector, 0.8 mm
- 26-538-16 Ball-tipped Dissector, 90 angle, 3 mm
- 26-539-17 Ball-tipped Dissector, 90 angle, 5 mm
- 26-540-18 Ball-tipped Dissector, 40 angle, 4 mm
- 26-541-19 Ball-tipped Dissector, 40 angle, 8 mm





# ELEVATORS

Elevatorien  
Elevadores

Elévateurs  
Elevatori



**SMITHWICK HOOK  
& DISSECTOR**  
**26-542-300**  
30 cm, 12" double ended  
5 mm semi-sharp end  
and 1 x 10 mm blunt hook



**26-543-45**  
angled 45°



**26-544-90**  
angled 90°



**NERVE PROBE ENDOSCOPIC**  
38 cm, 15"  
with ball end 80 mm tip &  
shaft length 29 cm, 11 1/2"  
handle length 7.1 mm  
shaft diameter



**PENFIELD ELEVATOR ENDOSCOPIC**  
**26-545-380**  
38 cm, 15"  
blunt, 4 mm tip width  
88 mm tip and shaft length, graduated  
29 cm, 11 1/2" handle length  
7.1 mm shaft diameter



*Elevatoren  
Elevadores*

*Elévateurs  
Elevatori*



**SACHS NERVE**  
26-546-185  
18.5 cm, 7 1/4"  
3 mm blunt

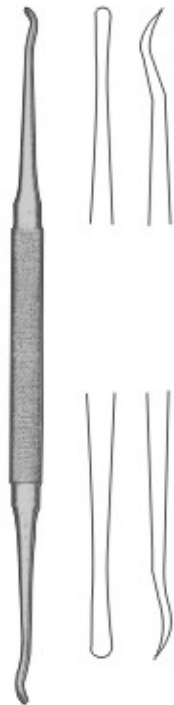

**KLEINERT KUTZ**  
Elevator and Dissector  
26-547-195  
19.5 cm, 7 3/4"  
2 mm x 3 mm Sharp ends



**FREER Elevator**  
26-548-185  
18.5 cm, 7 1/4"  
double ended  
5 mm sharp end  
5 mm blunt end



**WOODSON**  
Elevator/Spatula  
26-549-225  
22.5 cm, 9"  
double ended  
3 mm semi-blunt ends



**WOODSON DURAL**  
Separator/Packer  
26-550-175  
17.5 cm, 7"  
double ended with grooved  
blade 3 mm blunt end

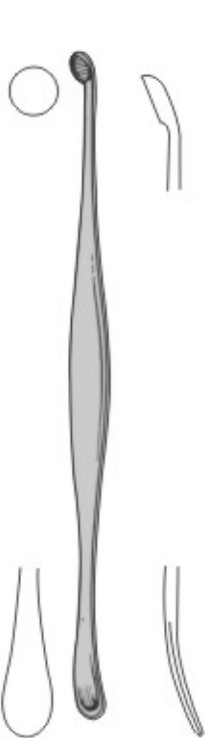

**26-551-175**  
style #1  
17.5 cm, 7"  
double ended

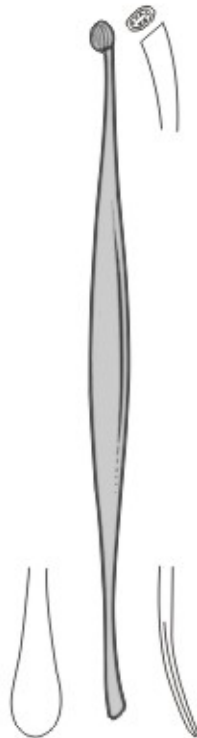

**26-552-185**  
style #2  
18.5 cm, 7 1/4"  
double ended

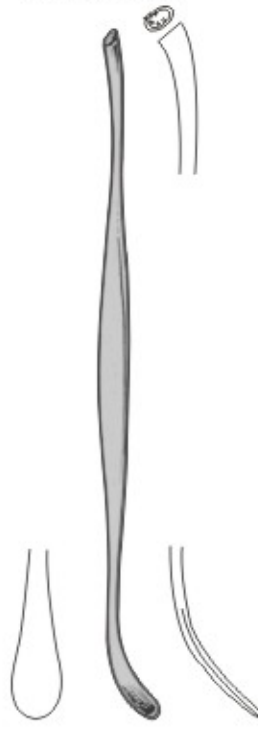

**PENFIELD Elevators**  
style #3  
26-553-280  
28 cm, 11"  
double ended



**26-554-280**  
style #4  
28 cm, 11"  
single ended

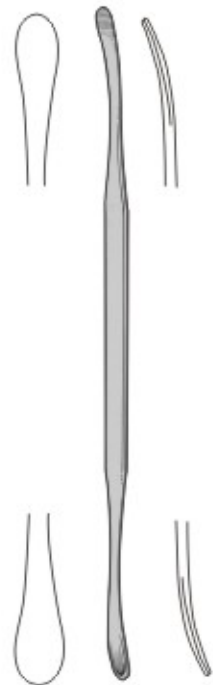

**26-555-185**  
style #5  
18.5 cm, 7 1/4"  
double ended



# REAMER, ELEVATORS, BONE FILES & ALVEOTOMY FILES

Reibahlen, Elevatorien, Knochenfeilen, Alveotomiefeilen

Pointes-carrées, Elévateurs, Limes à os, Limes pour alvéolotomie

Escariadores, Elevadores, Limas para huesos, Limas para alveolotomía

Punteruoli, Elevatori, Lime per ossa, Lime per alveolotomia



**26-556-140**  
14 cm, 5 1/2"

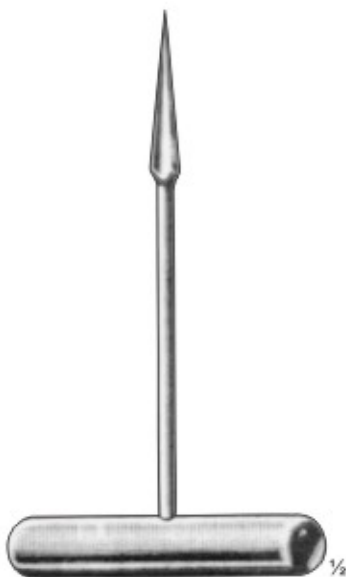

**26-557-140**  
14 cm, 5 1/2"



**PERTHES**  
**26-558-160** 16 cm, 6 1/2"  
**26-559-220** 22 cm, 8 3/4"



**BONE HOOK**  
**26-560-230**  
23 cm, 9"  
3 cm Dia.



**PUTTI**  
**26-561-280**  
27 cm, 10 1/2"



**PUTTI**  
**26-562-300**  
30 cm, 12"



Tip Size  
2 mm  
3 mm  
4 mm  
5 mm  
6 mm  
8 mm  
10 mm

**BONE TAMPS**  
**26-563-154**  
15.4 cm, 6"



**FOMAN RASP**  
**26-564-210**  
21 cm, 8 1/2"



**MILLER-COLBURN BONE FILE**  
**26-565-180**  
18 cm, 7"



Fig. 1  
**26-566-180**



Fig. 2  
**26-567-180**



Fig. 3  
**26-568-180**



Fig. 4  
**26-569-180**



cross cut



**MILLER ALVEOTOMY FILE**  
**26-570-190**  
19 cm, 7 1/2"



**MILLER ALVEOTOMY FILE**  
**26-571-190**  
19 cm, 7 1/2"





**COBB**  
24 cm, 9 1/4"



**COBB**  
24 cm, 9 1/4"



**26-572-01**  
Straight



**26-574-03**  
Strongly Curved



**26-576-05**  
Straight



**26-578-07**  
Strongly Curved



**26-573-02**  
Slightly Curved



**26-575-04**  
Curved down



**26-577-06**  
Slightly Curved



**26-579-08**  
Curved down



**HIBBS GOUGS** endoscopic.  
**26-580-460** 46 cm, 18"  
7 mm tip width straight, graduated



# OSTEOTOMES, GOUGES & CHISELS

Knochenmeißel, Hohlmeißel, Osteotome  
Cinceles, Gubias, Osteótomos

Ciseaux-burins, Gouges, Ostéotomes  
ScalPELLI, Sgorbie, Osteotomi



**LEXER Osteotome**  
22 cm, 8 3/4"

26-581-07	7 mm
26-582-10	10 mm
26-583-12	12 mm
26-584-15	15 mm
26-585-20	20 mm
26-586-25	25 mm
26-587-30	30 mm

**LEXER modif. Osteotome**  
29 cm, 11 1/2"

26-588-07	7 mm
26-589-10	10 mm
26-590-12	12 mm
26-591-15	15 mm
26-592-20	20 mm
26-593-25	25 mm
26-594-30	30 mm



**LEXER modif. Gouge**  
29 cm, 11 1/2"

26-595-07	7 mm
26-596-10	10 mm
26-597-12	12 mm
26-598-15	15 mm
26-599-20	20 mm
26-600-25	25 mm
26-601-30	30 mm

**LEXER Gouge**  
22 cm, 8 3/4"

26-602-07	7 mm
26-603-10	10 mm
26-604-12	12 mm
26-605-15	15 mm
26-606-20	20 mm
26-607-25	25 mm
26-608-30	30 mm



**LEXER**  
25 mm, 10"

26-609-07	7 mm
26-610-10	10 mm
26-611-15	15 mm

Straight



**LEXER**  
25 mm, 10"

26-612-07	7 mm
26-613-10	10 mm
26-614-15	15 mm

Curved



**FLAT**

26-615-10	10 mm
26-616-15	15 mm
26-617-20	20 mm
26-618-25	25 mm



**HOLLOW**

26-619-10	10 mm
26-620-15	15 mm
26-621-20	20 mm
26-622-25	25 mm



**MINI LEXER**  
26-623-180  
18 cm, 7"



**MINI LEXER**  
26-624-180  
18 cm, 7"  
Hollow

# OSTEOTOMES, GOUGES



Osteotome, Hohlmeißel  
Osteótomos, Gubias

Ostéotomes, Gouges  
Osteotomi, Sgorbie

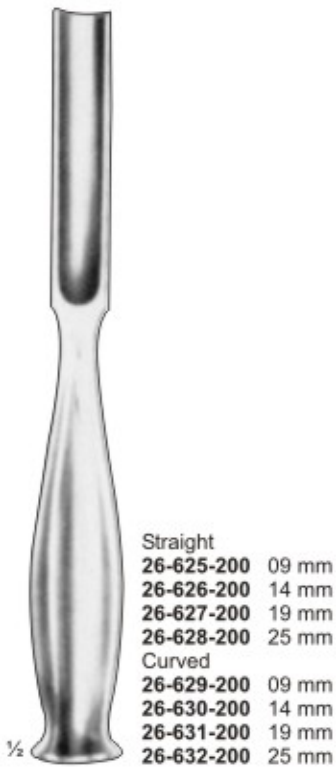

Straight  
26-625-200 09 mm  
26-626-200 14 mm  
26-627-200 19 mm  
26-628-200 25 mm  
Curved  
26-629-200 09 mm  
26-630-200 14 mm  
26-631-200 19 mm  
26-632-200 25 mm

**SMITH PETERSON**  
20 cm, 8"

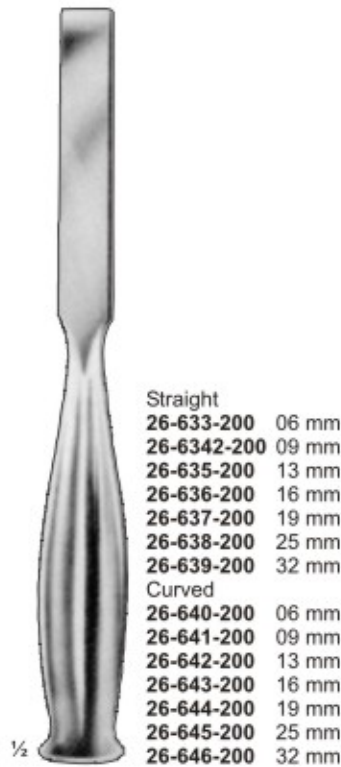

Straight  
26-633-200 06 mm  
26-6342-200 09 mm  
26-635-200 13 mm  
26-636-200 16 mm  
26-637-200 19 mm  
26-638-200 25 mm  
26-639-200 32 mm  
Curved  
26-640-200 06 mm  
26-641-200 09 mm  
26-642-200 13 mm  
26-643-200 16 mm  
26-644-200 19 mm  
26-645-200 25 mm  
26-646-200 32 mm

**SMITH PETERSON**  
20 cm, 8"



Straight  
26-647-200 10 mm  
26-648-200 15 mm  
26-649-200 20 mm  
26-650-200 25 mm  
Curved  
26-651-200 10 mm  
26-652-200 15 mm  
26-653-200 20 mm  
26-654-200 25 mm

**STILLE**  
20 cm, 8"

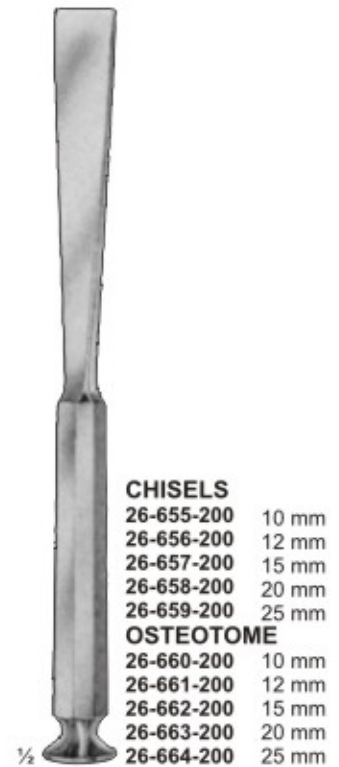

**CHISELS**  
26-655-200 10 mm  
26-656-200 12 mm  
26-657-200 15 mm  
26-658-200 20 mm  
26-659-200 25 mm  
**OSTEOTOME**  
26-660-200 10 mm  
26-661-200 12 mm  
26-662-200 15 mm  
26-663-200 20 mm  
26-664-200 25 mm

**STILLE**  
20 cm, 8"

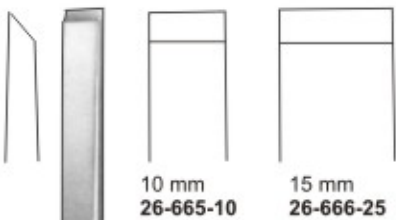

10 mm 26-665-10  
15 mm 26-666-25

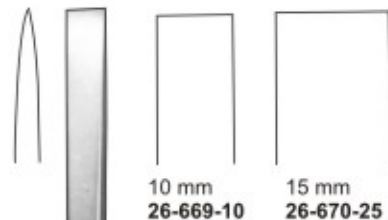

10 mm 26-669-10  
15 mm 26-670-25

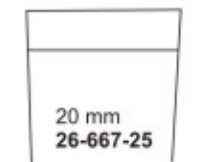

20 mm  
26-667-25

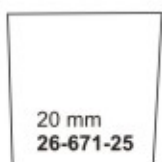

20 mm  
26-671-25

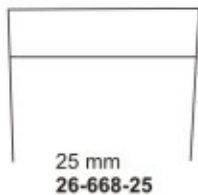

25 mm  
26-668-25



25 mm  
26-672-25

**STILLE**  
26-665-10 – 26-668-25  
20 cm, 8"

26-669-10 – 26-672-25  
20 cm, 8"



**CHISEL HANDLE**  
26-673-000



26-674-005 Chisel Blade 0.5 cm  
26-675-010 Chisel Blade 1.0 cm  
26-676-016 Chisel Blade 1.6 cm  
26-677-025 Chisel Blade 2.5 cm

26-678-005 Osteotome Blade 0.5 cm  
26-679-010 Osteotome Blade 1.0 cm  
26-680-016 Osteotome Blade 1.6 cm  
26-681-025 Osteotome Blade 2.5 cm



26-682-000  
Wrench for Chisel Handle



# OSTEOTOMES

Osteotome  
Osteótomos

Ostéotomes  
Osteotomi

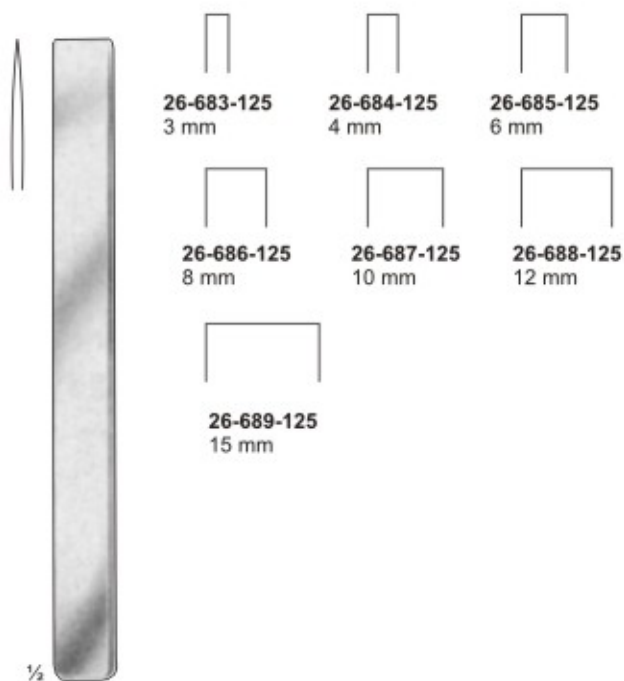

**MINI-LAMBOTTE**  
12.5 cm, 5"

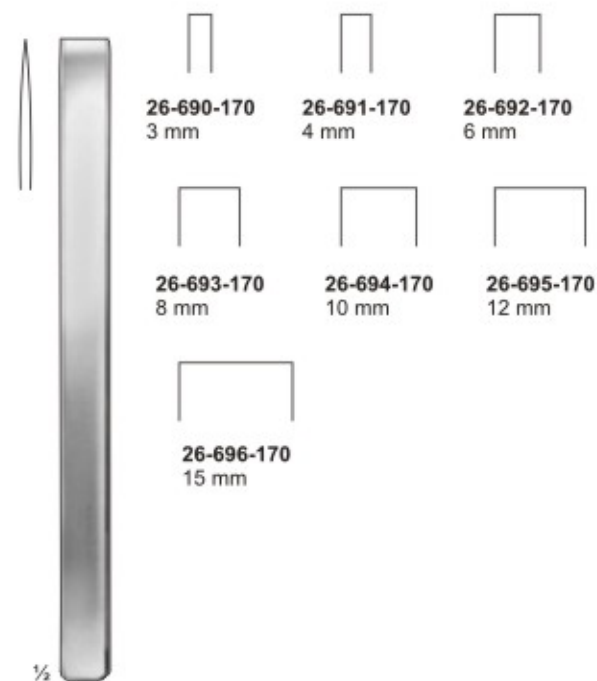

**MINI LAMBOTTE**  
17 cm, 6 3/4"

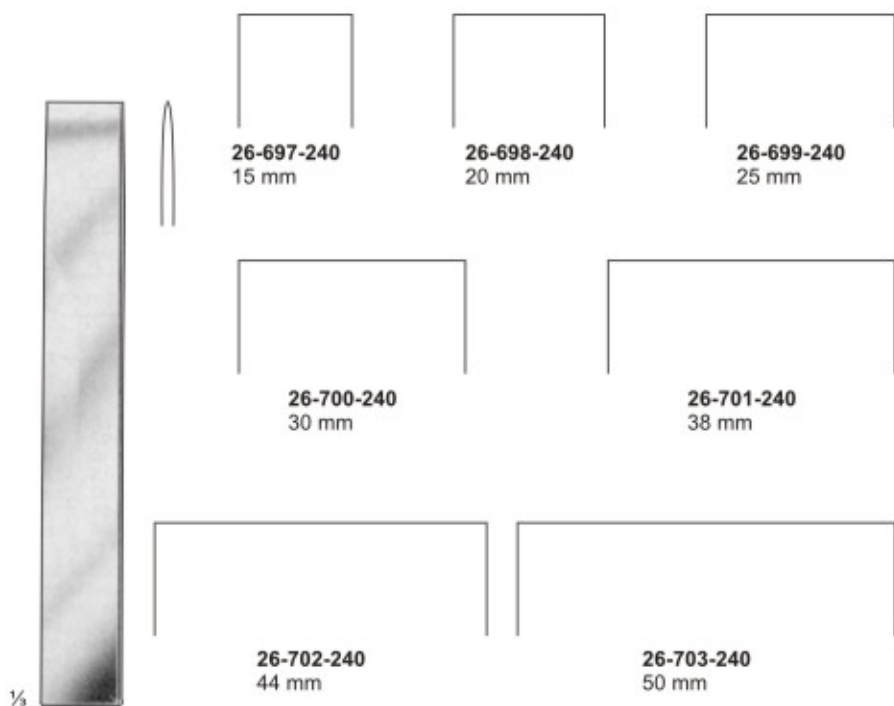

**LAMBOTTE**  
24 cm, 9 1/2"

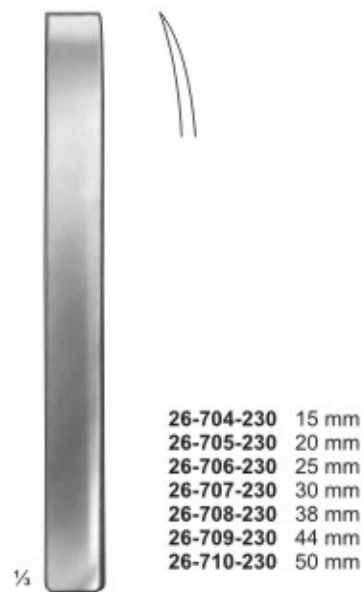

**LAMBOTTE**  
23 cm, 9"

# GOUGES

Gouges  
Sgorbie



Hohlmeißel  
Gubias

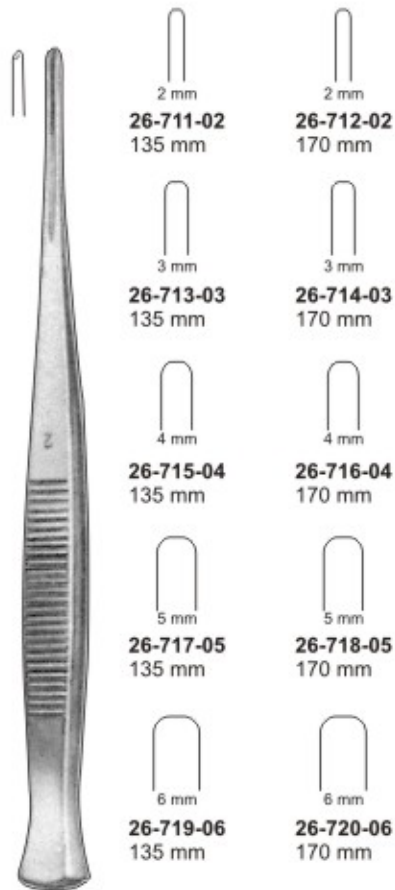

**PARTSCH**

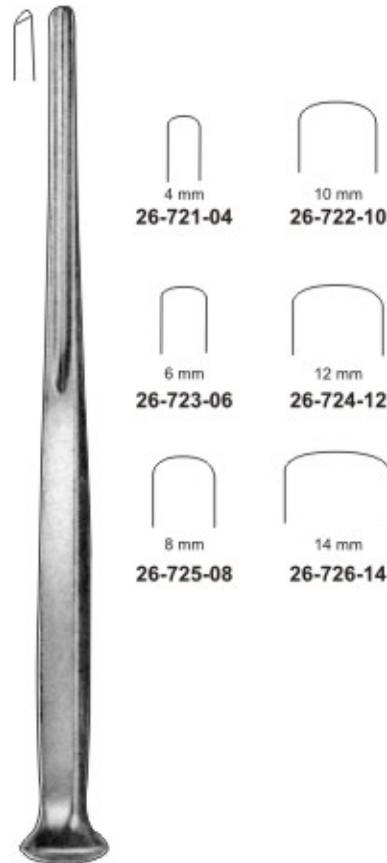

**ALEXANDER**



**SMITH PETERSON**

- |                  |          |       |
|------------------|----------|-------|
| <b>26-727-06</b> | Straight | 6 mm  |
| <b>26-728-09</b> | Straight | 9 mm  |
| <b>26-729-12</b> | Straight | 12 mm |
| <b>26-730-15</b> | Straight | 15 mm |
| <b>26-731-20</b> | Straight | 20 mm |
| <b>26-732-25</b> | Straight | 25 mm |
| <b>26-733-30</b> | Straight | 30 mm |
| <b>26-734-06</b> | Curved   | 6 mm  |
| <b>26-735-09</b> | Curved   | 9 mm  |
| <b>26-736-12</b> | Curved   | 12 mm |
| <b>26-737-15</b> | Curved   | 15 mm |
| <b>26-738-20</b> | Curved   | 20 mm |
| <b>26-739-25</b> | Curved   | 25 mm |
| <b>26-740-30</b> | Curved   | 30 mm |



**STILLE**

- |                  |          |       |
|------------------|----------|-------|
| <b>26-741-10</b> | Straight | 10 mm |
| <b>26-742-12</b> | Straight | 12 mm |
| <b>26-743-15</b> | Straight | 15 mm |
| <b>26-744-20</b> | Straight | 20 mm |
| <b>26-745-25</b> | Straight | 25 mm |
| <b>26-746-10</b> | Curved   | 10 mm |
| <b>26-747-12</b> | Curved   | 12 mm |
| <b>26-748-15</b> | Curved   | 15 mm |
| <b>26-749-20</b> | Curved   | 20 mm |
| <b>26-750-25</b> | Curved   | 25 mm |



- |                  |          |  |
|------------------|----------|--|
|                  | Straight |  |
| <b>26-751-05</b> | 5 mm     |  |
| <b>26-752-10</b> | 10 mm    |  |
| <b>26-753-15</b> | 15 mm    |  |



- |                  |        |  |
|------------------|--------|--|
|                  | Curved |  |
| <b>26-754-05</b> | 5 mm   |  |
| <b>26-755-10</b> | 10 mm  |  |
| <b>26-756-15</b> | 15 mm  |  |





## OSTEOTOMES, GOUGES

Hohlmeißel, Osteotome  
Gubias, Osteótomos

Gouges, Ostéotomes  
Sgorbie, Osteotomi



**SMITH-PETERSON**, 20 cm, 8"

Osteotome, Straight

26-757-06	6 mm
26-758-09	9 mm
26-759-12	12 mm
26-760-15	15 mm
26-761-20	20 mm
26-762-25	25 mm
26-763-30	30 mm



**SMITH-PETERSON**, 20 cm, 8"

Osteotome, curved

26-764-06	6 mm
26-765-09	9 mm
26-766-12	12 mm
26-767-15	15 mm
26-768-20	20 mm
26-769-25	25 mm
26-770-30	30 mm



**SMITH-PETERSON**, 20 cm, 8"

Gouge, Straight

26-771-06	6 mm
26-772-09	9 mm
26-773-12	12 mm
26-774-15	15 mm
26-775-20	20 mm
26-776-25	25 mm
26-777-30	30 mm



**SMITH-PETERSON**, 20 cm, 8"

Gouge, curved

26-778-06	6 mm
26-779-09	9 mm
26-780-12	12 mm
26-781-15	15 mm
26-782-20	20 mm
26-783-25	25 mm
26-784-30	30 mm



**LAMBOTTE**, 24 cm, 9 1/2"

Osteotome, Straight

26-785-06	6 mm
26-786-09	9 mm
26-787-12	12 mm
26-788-15	15 mm
26-789-20	20 mm
26-790-25	25 mm
26-791-30	30 mm

# ELEVATORS



*Elevatorien  
Elevadores*

*Élévateurs  
Elevatori*



**26-792-12**  
12 mm



**26-793-19**  
19 mm



**26-794-25**  
25 mm



**26-795-32**  
32 mm

**COBB SPINAL** Elevator  
23.8 cm, 9 1/2" sharp  
with hexagonal handle



**HARRINGTON SPINAL**  
Elevator  
**26-796-19**  
30 cm, 12", Sharp  
19 mm tip width



7 mm



9 mm



11 mm

**COBB MODIF.**  
**26-797-07** 7 mm  
**26-798-09** 9 mm  
**26-799-11** 11 mm  
28 cm, 11" Round Handle



4 mm



6 mm



8 mm

**COBB MODIF.**  
**26-800-04** 4 mm  
**26-801-06** 6 mm  
**26-802-08** 8 mm  
28 cm, 11" Round Handle



7 mm

15 mm

20 mm



**26-803-07**  
16 cm, 6 1/4"



**26-804-15**  
19 cm, 7 1/2"

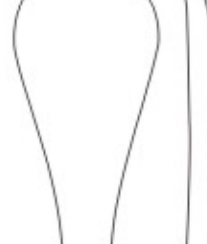

**26-805-20**  
20 cm, 8"

**HOEN**



**SEBILEAU**  
**26-806-175**  
17.5 cm, 7"



# PERIOSTEAL ELEVATORS

Raspatorien  
Periostótomos

Rugines-raspatoires  
Periostotomi



**PERIOSTEAL Elevator**  
26-807-182  
18.2 cm, 7"  
Fiber/Phenolic Handle  
blade 6mm



**CHANDLER Bone Elevator**

26-808-190  
19 cm, 7 1/2" 13 mm  
26-809-200  
20 cm, 8" 20 mm  
26-810-230  
23 cm, 9" 25 mm  
26-811-250  
25 cm, 10" 31 mm



**HOEN PERIOSTEAL Elevator**  
26-812-165  
16.5 cm, 6 1/2"



**KEY PERIOSTEAL Elevator**  
26-813-180  
18 cm, 7 1/2"



**KEY (Fig. A)**

Fig.	Item	Description	Inch.	Width
A	26-814-190	19 cm	7 1/2"	3 mm
A	26-815-190	19 cm	7 1/2"	6 mm
A	26-816-190	19 cm	7 1/2"	9 mm
A	26-817-190	19 cm	7 1/2"	12 mm
A	26-818-190	19 cm	7 1/2"	15 mm
A	26-819-190	19 cm	7 1/2"	19 mm
A	26-820-190	19 cm	7 1/2"	25 mm



**COBB Elevators**  
26-821-234  
23.4 cm, 9"  
Hex Handle



**PERIOSTEAL ELEVATOR**  
26-822-170  
17 cm, 7"

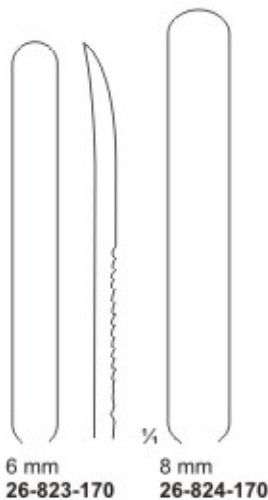

6 mm 26-823-170  
8 mm 26-824-170



**DOYEN RIB RASPATORY**  
26-825-170  
17 cm, 7"



26-826-170  
Right Crved  
For Adults

26-827-170  
Left Crved  
For Adults

26-828-170  
Right Crved  
For Children

26-829-170  
Left Crved  
For Children



**ADSON ELEVATOR**  
26-830-170  
17 cm, 7"

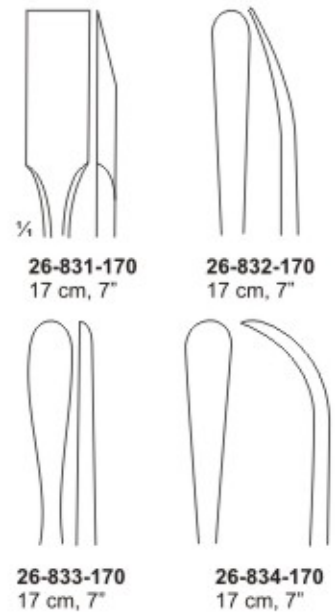

26-831-170  
17 cm, 7"

26-832-170  
17 cm, 7"

26-833-170  
17 cm, 7"

26-834-170  
17 cm, 7"

# PERIOSTEAL ELEVATORS

Raspatorien  
Periostótomos

Rugines-raspatoires  
Periostotomi



**ST. THOMAS**  
26-835-160  
16 cm, 6 1/2"  
Pointed



**ST. THOMAS**  
26-836-160  
16 cm, 6 1/2"  
Rounded



**ROBINSON'S**  
26-837-170  
17 cm, 7"



**WILLIGER**  
26-838-130  
13 cm, 5"



**WILLIGER**  
26-839-160  
16 cm, 6 1/2"



**LANE**  
26-840-160  
16 cm, 6 1/2"  
Serrated



**LANE**  
26-841-270  
27 cm, 10 1/2"



**TRETHOWAN'S**  
26-842-220  
22 cm, 9"



**BRISTOW'S**  
26-843-240  
24 cm, 9 1/2"



**SEDILLOT**  
26-844-210  
21 cm, 8 1/4"



# PERIOSTEAL ELEVATORS

Raspatorien  
Periostótomos

Rugines-raspatoires  
Periostotomi



**KEY**  
 26-845-06 6 mm  
 26-846-12 12 mm  
 26-847-20 20 mm  
 26-848-25 25 mm  
 190 cm, 7 1/2" sharp, slightly curved



**PENNYBACKER**  
 26-849-06 6 mm  
 17 cm, 6 3/4" sharp, curved



**LANGENBECK**  
 26-850-15 15 mm  
 19 cm, 7 1/2" sharp, slightly curved



**CUSHING** 15 mm  
 26-851-01 round edge  
 26-852-02 Square edge  
 18 cm, 7"



**ADSON**  
 26-853-170  
 17 cm, 6 3/4"



**HOEN**  
 26-854-07 7 mm  
 16 cm, 6 1/4"  
 26-855-15 15 mm  
 19 cm, 6 1/4"  
 26-856-20 20 mm  
 19 cm, 6 1/4" Semisharp

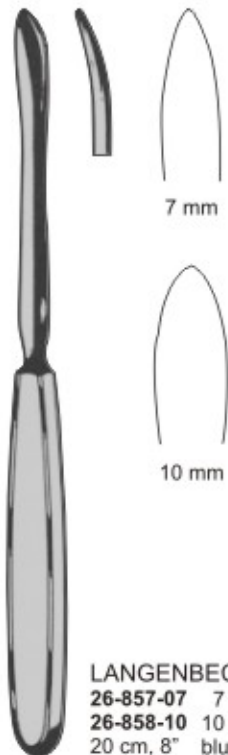

**LANGENBECK**  
 26-857-07 7 mm  
 26-858-10 10 mm  
 20 cm, 8" blunt



**CUSHING**  
 19 cm, 7 1/2"  
 26-859-19 Left  
 26-860-19 Right



**26-861-06**  
 6 mm, 185 mm sharp, curved



**26-862-13**  
 13 mm, 200 mm sharp, curved

# PERIOSTEAL ELEVATORS



Raspatorien  
Periostótomos

Rugines-raspatoires  
Periostotomi



1/2

**26-863-200**  
20 cm, 8"  
Medium straight  
blade round edge,  
width 14 mm



1/2

**26-864-200**  
20 cm, 8"  
Medium curved  
blade round edge,  
width 14 mm



1/2

**26-865-180**  
18 cm, 7"  
Small curved  
blade round edge,  
width 6 mm



1/2

**26-866-180**  
18 cm, 7"  
Small curved  
blade straight edge,  
width 6 mm



1/2

**26-867-180**  
18 cm, 7"  
Extra small  
curved blade  
round edge,  
width 3 mm



1/2

**26-868-200**  
20 cm, 8"  
Large straight blade  
round edge,  
width 20 mm



Medium Blade  
Straight Edge, 14 mm  
**26-869-185**  
Straight 18.5 cm, 7 1/2"  
**26-870-185**  
Curved 18.5 cm, 7 1/2"



1/2

**LANGENBECK**  
**26-871-180**  
18 cm, 7"



1/2

**LANGENBECK**  
**26-872-190**  
19 cm, 7 1/2"



1/2

**LAMBOTTE**  
**26-873-210** 21 cm, 8 1/2"  
**26-874-210** 1.0 cm  
**26-8741-210** 1.5 cm  
**26-875-210** 2.0 cm



1/2

**FARABEUF**  
**26-876-150**  
15 cm, 6"



1/2

**FARABEUF**  
**26-877-150**  
15 cm, 6"



1/2

**26-878-160** 5 mm  
**26-879-160** 6 mm  
**26-880-160** 7 mm  
16 cm, 6 1/2"



# ELEVATORS

Elevatoren  
Elevadores

Élévateurs  
Elevatori



**CARROLL** Periosteal Elevator  
**26-881-140**  
14 cm, 5 1/2" sharp, double ended  
3 mm round end, 10 mm flat end



**ADSON** Periosteal 17 cm, 6 1/4"  
**26-882-01** Sharp 7 mm straight  
**26-883-02** blunt 7 mm curved  
**26-884-03** semi-sharp 7 mm straight  
**26-885-04** semi-sharp 7 mm curved



**CUSHING** Periosteal Elevator  
**26-886-185** 18.5 cm, 7 1/4", 15 mm sharp, straight  
**26-887-185** curved



**LANGENBECK**  
Periosteal Elevator  
19.5 cm, 7 3/4"  
**26-888-01** blunt edge  
**26-889-02** sharp edge



Key Periosteal Elevator sharp edge  
**26-890-06** 17.7 cm, 7" 6.5 mm width  
**26-891-09** 18.5 cm, 7 1/4" 9.5 mm width  
**26-892-12** 18.5 cm, 7 1/4" 12.7 mm width  
**26-893-19** 20.0 cm, 8" 19.0 mm width  
**26-894-25** 20.9 cm, 8 1/4" 25.0 mm width

# BONE LEVERS, KNEE RETRACTORS & SPINAL RETRACTORS

Knochenhebel, Kniehaken, Spinalhaken  
Elevadores para hueso, Separadores para le genou,

Leviers á os, Ecarteurs pour le genou, Ecarteurs spinaux  
Elevatori per ossa, Divaricatori per il ginocchio,



**AUFRANC**  
26-895-290  
29 cm, 11 1/2"



**AUFRANC**  
26-896-290  
29 cm, 11 1/2"



**AUFRANC**  
26-897-290  
29 cm, 11 1/2"



**BLOUNT KNEE  
RETRACTOR**  
26-898-175  
17.5 cm, 7"



**BENNETT**  
26-899-260  
24 cm, 9 1/2"  
43 mm, 60 mm,  
65 mm,

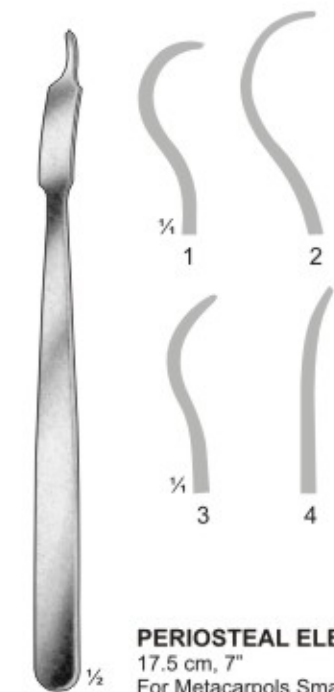

26-900-175

**PERIOSTEAL ELEVATOR**

17.5 cm, 7"

For Metacarpals Small

6 mm width

26-901-175

For Metacarpals Medium

10 mm width

26-902-175

Light Curve, Rounded End,

5 mm width

26-903-175

Contra Angled Curve

4.5 mm width



26-904-180

18 cm, 7"

Small, width 6 mm  
short, narrow tip



26-905-180

18 cm, 7"

Small, width 8 mm  
short, narrow tip



26-906-160

12.5 cm, 5"

For Small Fragments  
Board Shank



26-907-200

20 cm, 8"

Width 8 mm  
short, narrow tip



26-908-200

20 cm, 8"  
Width 18 mm short,  
narrow tip

26-909-200 20 cm, 8"  
Width 18 mm long,  
narrow tip





## BONE LEVERS, KNEE RETRACTORS & SPINAL RETRACTORS

*Knochenhebel, Kniehaken, Spinalhaken*  
*Elevadores para hueso, Separadores para le genou,*

*Leviers à os, Ecarteurs pour le genou, Ecarteurs spinaux*  
*Elevatori per ossa, Divaricatori per il ginocchio,*



**HOHMANN**  
26-910-150  
15 cm, 6"



**HOHMANN**  
26-911-154  
15.4 cm, 6"  
Short tip



**26-912-180** 18 cm, 7"  
Width 43 mm  
narrow tip  
**26-913-180** 18 cm, 7"  
Width 70 mm  
narrow tip



**26-914-180** 18 cm, 7"  
Width 43 mm  
long shank, angled



**26-915-160** 16 cm, 6 1/2"  
width 22 mm wide tip



**26-916-160** 16 cm, 6 1/2"  
long wire tip for Hip  
Surgery, width 24 mm



**LANGE-HOHMANN**  
26-917-240 24 cm, 9 1/2"  
26-918-240 26 cm, 10 1/2"  
26-919-240 29 cm, 11 1/2"



**RETRACTOR  
FOR KNEE**  
26-920-270  
27 cm, 11" Blunt



**ALEXANDER**  
26-921-200  
20 cm, 8"



**MATSON**  
26-922-220  
22 cm, 9"

# RETRACTORS



Wundhaken  
Separadores

Ecarteurs  
Divaricatori



**CUSHING VEIN** Retractor  
**26-923-225**  
22.5 cm, 9"  
with fenestrated handle  
Blade 12 mm width x 10 mm



**CUSHING DECOMPRESSION**  
Retractor  
**26-924-21**  
21.5 cm, 8 1/2"  
with fenestrated blade and handle  
Blade 13 mm width x 22 mm



**SCOVILLE** 24 cm, 9 1/2"  
straight  
**26-925-01**  
carved  
**26-926-02**  
7 mm

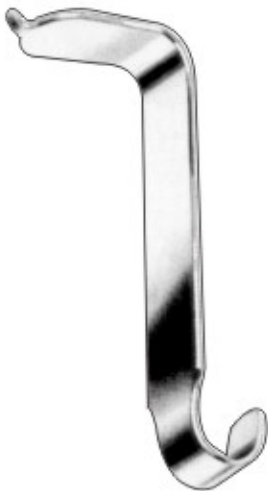

**TAYLOR**  
17 cm, 6 3/4"  
**26-927-170** 30 x 75 mm  
**26-928-170** 30 x 100 mm



**HIBBS**  
25 x 75 mm, 23 cm, 9"  
**26-929-230**  
25 x 80 mm, 24 cm, 9 1/2"  
**26-930-240**



Meyerding  
16 X 50 mm, 20 cm, 8"  
**26-931-200**  
25 X 75 mm, 23 cm, 9"  
**26-932-230**  
50 X 90 mm, 24 cm, 9 1/2"  
**26-933-240**



## RETRACTORS

Wundhaken  
Separadores

Ecarteurs  
Divaricatori



**SENN Retractor**  
16 cm, 6 1/4"  
**26-934-01** 3 sharp prongs  
**26-935-02** 3 blunt prongs



**LITTLE RETRACTOR**  
**26-936-190**  
19 cm, 7 1/2"  
Blade 7 mm x 18 mm



**BLADE RETRACTOR**  
18 cm, 7"  
**26-937-18** 18 mm x 76 mm  
**26-938-20** 20 mm x 76 mm  
**26-939-23** 23 mm x 76 mm

# DURA DISSECTORS



*Duradissectoren*  
*Disecadores Para Duramadre*

*Dissecteurs à Dure-mère*  
*Dissettori Per La Dura-madre*



**FRAZIER**  
26-940-150  
15 cm, 6"



**HOEN**  
26-941-150  
15 cm, 6"  
90°



**HORSLEY**  
26-942-200  
20 cm, 8"



26-943-01  
wide



26-944-02  
narrow



**TOENNIS**  
24 cm, 8 1/2"



**DAVIS**  
26-945-04 4 mm  
24.5 cm, 9 3/4"



**OLIVECRONE**  
26-946-180 18 cm, 7"  
26-947-240 24 cm, 9 1/2"  
delicate pattern



**OLIVECRONE**  
26-948-180 18 cm, 7"  
26-949-240 24 cm, 9 1/2"  
heavy pattern



# MICRO INSTRUMENTS



### DISSECTOR

18.5 cm, 7 1/4"

26-952-10 1.0 mm  
26-953-15 1.5 mm  
26-954-20 2.0 mm

23 cm, 9"

26-955-10 1.0 mm  
26-956-15 1.5 mm  
26-957-20 2.0 mm



### RASPATORY, round

18.5 cm, 7 1/4"

26-958-20 2.0 mm  
26-959-30 3.0 mm

23 cm, 9"

26-960-20 2.0 mm  
26-961-30 3.0 mm



### CURETTE

26-962-15 18.5 cm, 7 1/4", 1.5 mm  
26-963-15 23.0 cm, 9", 1.5 mm  
straight



### CURETTE

26-964-15 18.5 cm, 7 1/4", 1.5 mm  
26-965-15 23.0 cm, 9", 1.5 mm  
angled



### HOOK

26-950-185 18.5 cm, 7 1/4" 1.5 mm, 90°  
26-951-230 23.0 cm, 9" 1.5 mm, 90°  
sharp



### HOOK

26-966-15 18.5 cm, 7 1/4" 1.5 mm, 90°  
26-967-15 23.0 cm, 9" 1.5 mm, 90°  
blunt



### TISSUE LIFTER

26-968-10 18.5 cm, 7 1/4" 1.0 mm  
26-969-15 1.5 mm

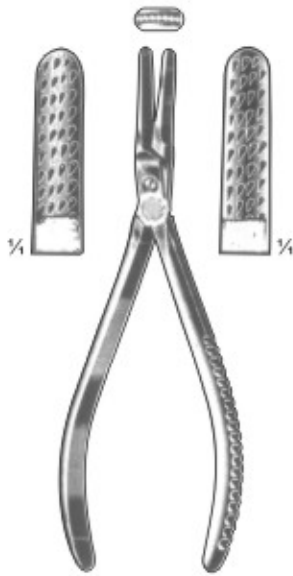

**NAIL EXTRACTING  
FORCEPS**  
26-970-140  
14 cm, 5 1/2"

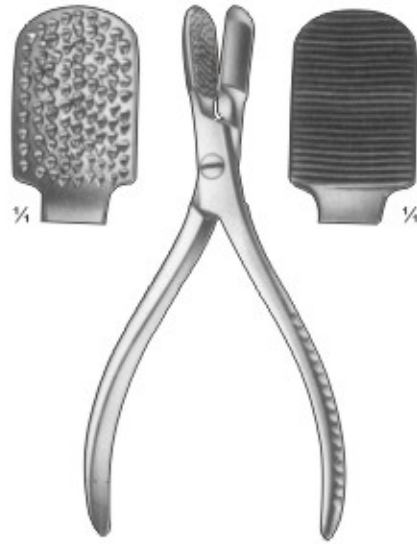

**NAIL EXTRACTING  
FORCEPS**  
26-971-145  
14.5 cm, 5 3/4"

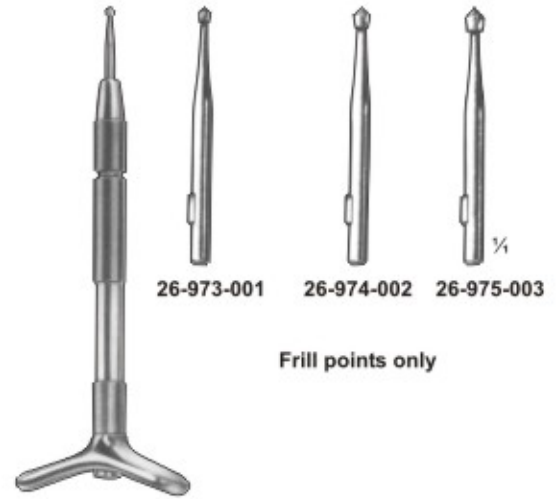

**26-972-000**  
Finger nail drill with 3  
drill points

Frill points only

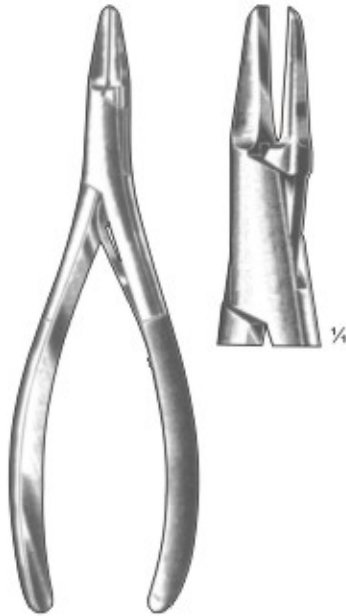

**NAIL SPLITTING  
FORCEPS**  
26-976-135  
13.5 cm, 5 1/4"



**RING CUTTER**  
26-977-170  
17 cm, 6 3/4"

**26-978-000**  
Saw Blade Only  
for 26-977-170

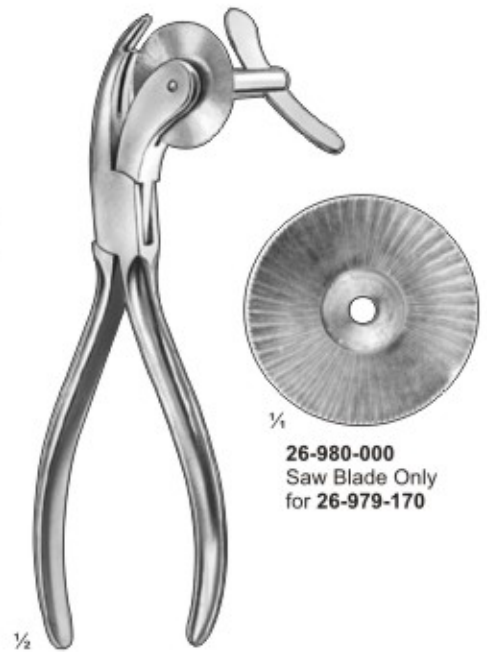

**RING CUTTER**  
26-979-170  
17 cm, 6 3/4"

**26-980-000**  
Saw Blade Only  
for 26-979-170



# FLAT NOSE PLIERS, TENDON TUNNELLING FORCEPS

Flachzangen, Sehnendurchzugzangen  
Alicates de pico plano, Pinzas para pasar tendones

Pincas plates, Pincas pour passer les tendons  
Tenaglie piatte, pinze passa-tendini

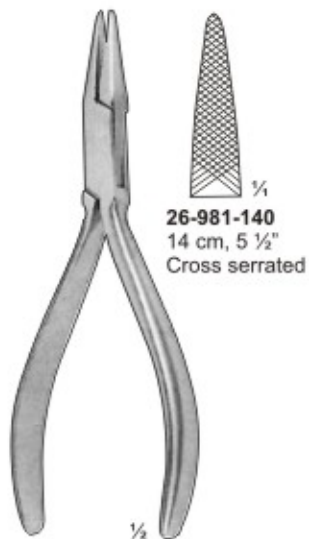

**26-981-140**  
14 cm, 5 1/2"  
Cross serrated

**NEEDLE  
NOSE PLIERS**

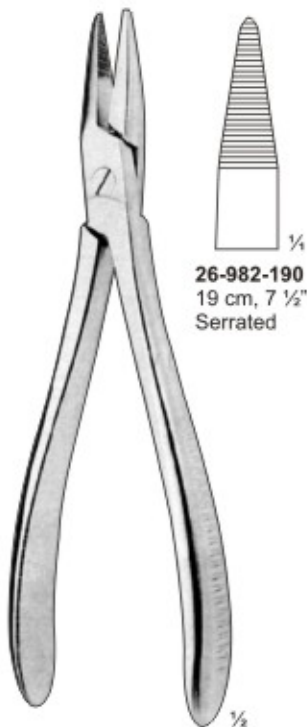

**26-982-190**  
19 cm, 7 1/2"  
Serrated

**NEEDLE  
NOSE PLIERS**



**FLAT NOSE**  
**26-983-180**  
18 cm, 7"



**26-984-153**  
15.25 cm, 6"  
6 mm

**TENDON**

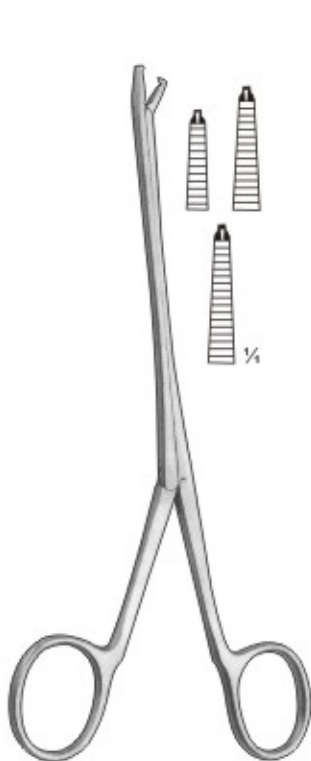

**BRAND**  
**26-985-150** 15 cm, 6"  
**26-986-190** 19 cm, 7 1/2"  
**26-987-240** 24 cm, 9 1/2"

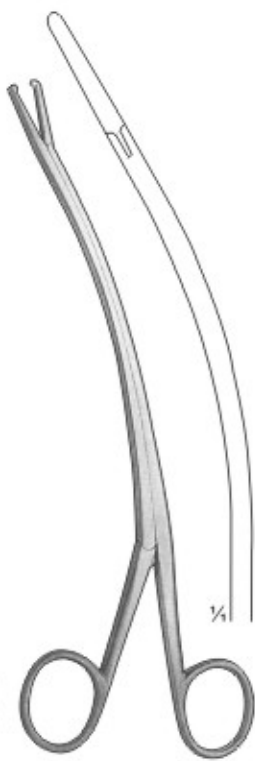

**BRAND**  
**26-988-150** 15 cm, 6"  
**26-989-190** 19 cm, 7 1/2"  
**26-990-240** 24 cm, 9 1/2"



**CARROLL**  
**26-991-130**  
13 cm, 5"  
Curved Shaft  
2 mm x 6 mm

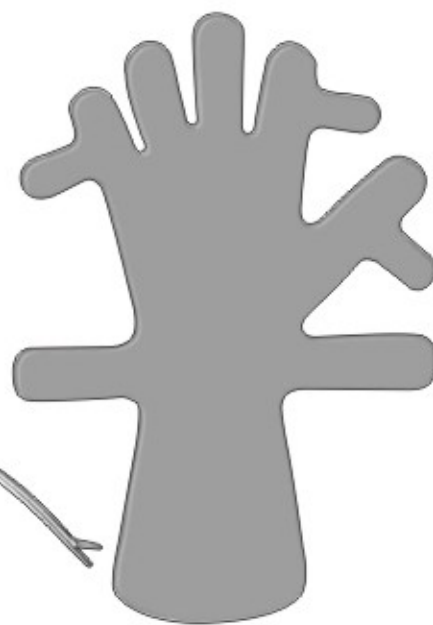

**LEAD HAND**  
**26-992-000**  
Adult Size

# FLAT NOSE, COMBI-FLAT, VISE GRIP PLIERS

Flachzangen, Tonnenzange, Kombinationszange  
Alicates de pico plano, Combi-Alicate de alambre

Pinces plates, Combi-Pince pour fils  
Tenaglie piatte, Combi-Pinza per fili



**FLAT NOSED  
PARALLEL PLIERS**  
26-993-180 18 cm, 7"  
with lateral wire cutter

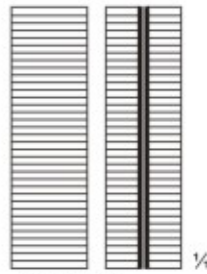

**26-994-170**  
17 cm, 6 1/2"  
Grooved, Serrated

**FLAT NOSED  
PARALLEL PLIERS**



**26-995-150**  
18 cm, 7"  
With Spring  
serrated

**LOCKING PLIERS**



**FLAT NOSED PLIER**  
26-996-210 18 cm, 7"  
parallell, with lateral  
wire cutter



**LOUTE**  
26-997-210  
21 cm, 8 1/2"



**MODEL USA**



**26-998-230**  
23 cm, 9"  
3 Prong

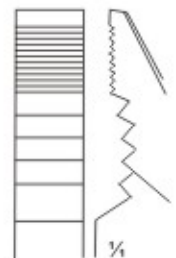
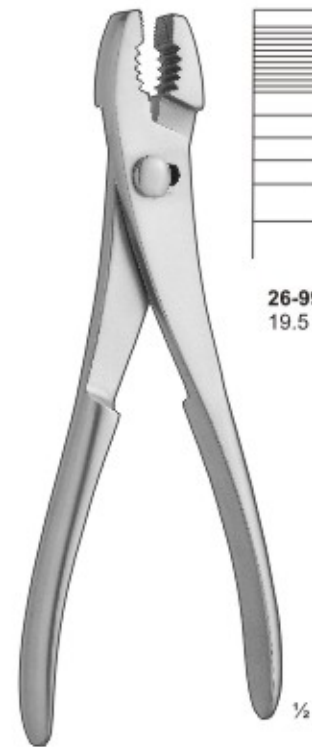

**26-999-195**  
19.5 cm, 8"

**SLIP JOINT**





# ORTHOPAEDICS

Orthopädie  
Ortopedia

Orthopédie  
Ortopedia

## WIRE INSTRUMENTS



**26-1000-180 EXTRACTION Pliers**  
18 cm, 7"  
**26-1001-180 TC jaws**



**EXTRACTION Pliers**  
**26-1002-130** 13 cm, 5"  
**26-1003-180** 18 cm, 7"



**EXTRACTION Pliers**  
**26-1004-19**  
19 cm, 7 1/2" TC



**EXTRACTION Pliers**  
**26-1005-19**  
20cm, 8" TC



**FLAT-NOSED Pliers**  
parallel,  
**26-1006-180**  
18 cm, 7"  
Stainless Steel



**FLAT-NOSED Pliers**  
parallel  
**26-1007-180**  
with lateral wire cutter,  
18 cm, 7"  
Stainless Steel



**WISE GRIP**  
**26-1008-18** 18 cm, 7"  
**26-1009-20** 20 cm, 8"  
**26-1010-24** 24 cm, 9 1/2"  
Stainless Steel



**WIRE TIGHTENING Pliers**  
**26-1011-180**  
18 mm, 7"  
T/C

# FLAT NOSE, COMBI-FLAT PLIERS

Flachzangen, Tonnenzange, Kombinationszange  
Alicates de pico plano, Combi-Alicate de alambre

Pinces plates, Combi-Pince pour fils  
Tenaglie piatte, Combi-Pinza per fili

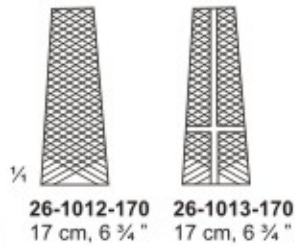

26-1012-170  
17 cm, 6 3/4"

26-1013-170  
17 cm, 6 3/4"

**WIRE FORCEPS**  
26-1012-170  
with serrated jaws  
26-1013-170  
with longitudinal and  
transversal grooves

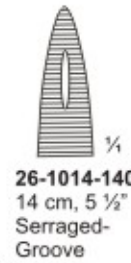

26-1014-140  
14 cm, 5 1/2"  
Serrated-  
Groove

**NEEDLE NOSED**



**EXTRACTION PLIERS**  
26-1015-130 13 cm, 5"  
26-1016-180 18 cm, 7"



**NAIL EXTRACTOR**  
26-1017-160 16 cm, 6 1/2"  
with Longitudinal Groove  
(for Intramedullary Gliding Nails)



# ORTHOPAEDICS

Orthopädie  
Ortopedia

Orthopédie  
Ortopedia

## WIRE INSTRUMENTS



**26-1018-50**  
Bending Iron  
for Kirschner Wires



**26-1019-20**  
**26-1020-25**  
Pliers with serrated  
jaws and groove  
jaws without groove

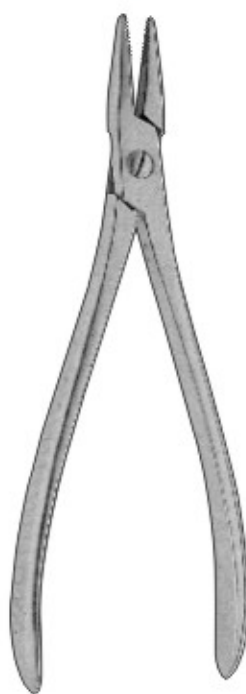

**26-1021-18**  
Rounded Pliers with  
serrated jaws



**26-1022-10**  
Wire Bending Cutting  
Pliers soft wire 1.5 mm  
Hard Wire 1.0 mm



**26-1023-10**  
**26-1024-12**  
Universal Scissors  
Universal Scissors  
with TC cutting edges



**26-1025-15**  
Wire Cutter T/C



**26-1026-10**  
Wire Bending Pliers  
soft Wire 1.5 mm  
Hard Wire 1.0 mm



**26-1027-12**  
Wire Cutter  
soft wire 2.0 mm  
hard wire 1.2 mm

# EXTENSION PIN, BOW



*Extensiionsnägel, Extensionsbügel,  
Clavos de extensión, Extribos para extensión*

*Clous à os, Etriers à extension,  
Chiodi per ossa, Archi per estensione,*

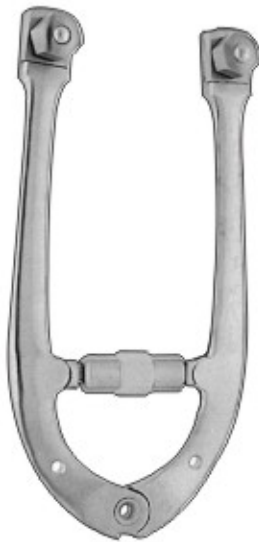

### KIRSCHNER

26-1028-00 40 x 140 mm  
26-1029-00 60 x 220 mm

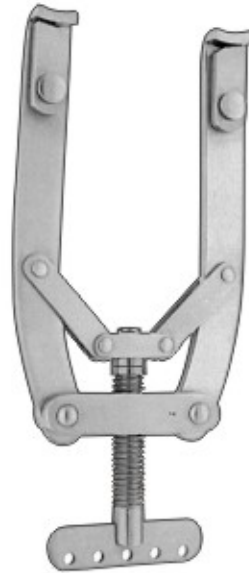

### KIRSCHNER, AMERICAN TYPE

26-1030-00 Medium 130 mm  
26-1031-00 Large 185 mm  
26-1032-00 Extra Large 220 mm  
Max. Jaw Opening



### KIRSCHNER

26-1033-00 200 mm x 155 mm  
26-1034-00 155 mm x 155 mm  
26-1035-00 135 mm x 130 mm  
26-1036-00 120 mm x 120 mm  
26-1037-00 105 mm x 100 mm  
26-1038-00 95 mm x 110 mm  
26-1039-00 95 mm x 70 mm



### SCREW NUT WRENCH

26-1040-00  
14 x 17 mm

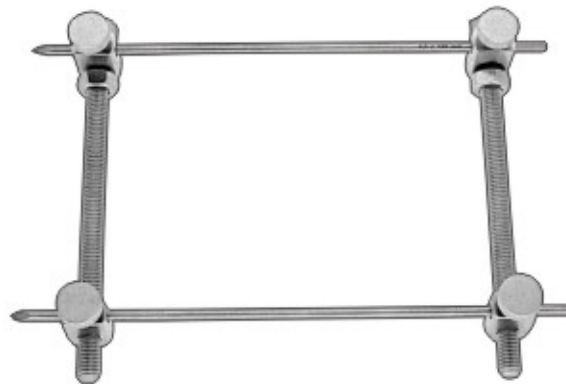

### CHARNLEY-MUELLER

26-1042-00  
Compression Clamp

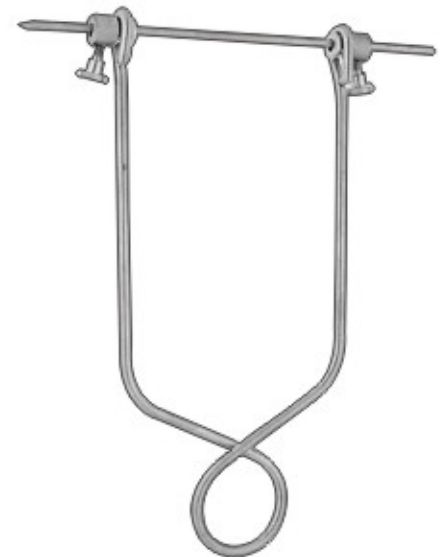

	Inside Length	Inside Width
26-1043-00	90 mm	75 mm
26-1044-00	160 mm	90 mm
26-1045-00	210 mm	110 mm
26-1046-00	210 mm	150 mm



# BONE RONGEURS

Hohlmeißelzangen  
Pinzas gubias

Pinces-gouges  
Pinze-sgorbie

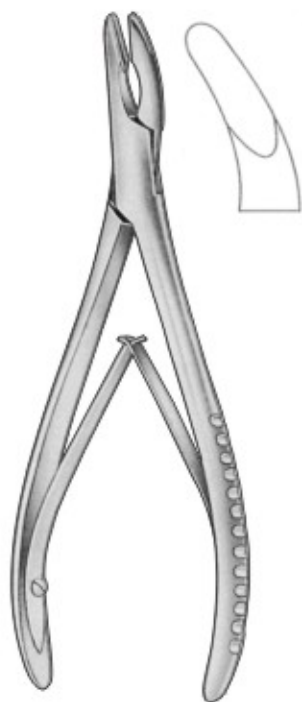

**HARTMANN**  
26-1047-185  
18.5 cm, 7 1/4"

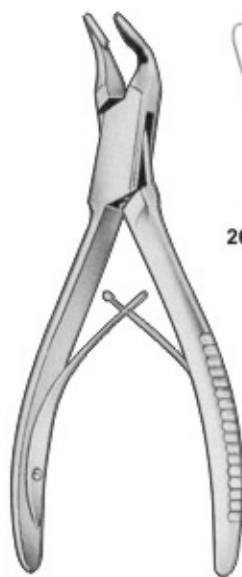

**BLUMENTHAL**  
15 cm, 6"

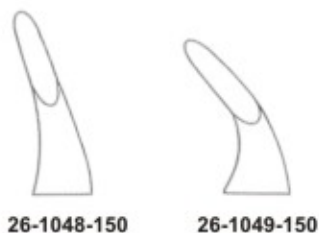

26-1048-150

26-1049-150



26-1050-150



**LUER**  
15 cm, 6"



26-1051-150

26-1052-150



26-1053-150



**FRIEDMAN &  
MINI-FRIEDMAN**



26-1054-120  
12 cm, 4 3/4"  
Curved



26-1055-140  
14 cm, 5 1/2"  
Curved



**UNIVERSAL**



26-1056-133  
13.25 cm, 5 1/2"  
Angled  
17 mm x 3.5 mm



**BACON**  
26-1057-200  
20 cm, 8"

# BONE RONGEURS



Hohlmeißelzangen  
Pinzas gubias

Pinces-gouges  
Pinze-sgorbie



26-1058-175  
17.5 cm, 7"



26-1059-175  
17 cm, 6 3/4"



1/4

1/4

## LUER

26-1060-170 17 cm, 6 3/4" straight  
26-1061-170 17 cm, 6 3/4" curved



1/4

26-1062-153  
15.5 cm, 6"  
Curved-Small  
9 mm x 3.5 mm

## LUER

## STELLBRINK SYNOVCTOMY RONGEUR



CLEVELAND  
26-1063-140  
14 cm, 5 1/2"

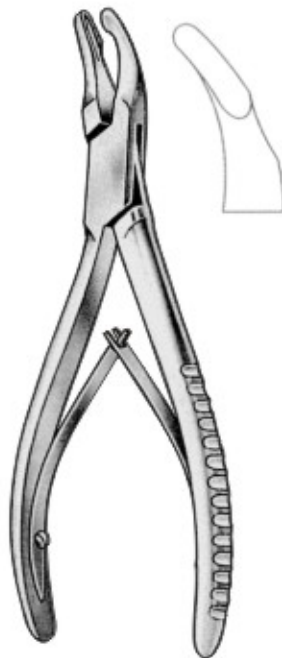

CLEVELAND  
26-1064-170  
17 cm, 6 3/4"



MEAD  
16.5 cm, 6 1/2"



26-1065-165



26-1066-165



## BONE RONGEURS

Hohlmeißelzangen  
Pinzas gubias

Pinces-gouges  
Pinze-sgorbie



**LEMPERT**  
26-1067-190 19 cm, 7 1/2" straight  
26-1068-190 19 cm, 7 1/2" curved



**LEMPERT**



1/4  
**26-1069-160**  
16 cm, 6 1/2"  
Curved  
**26-1070-190**  
19 cm, 7 1/2"  
Straight  
12 mm x 3 mm  
**26-1071-190**  
19 cm, 7 1/2"  
Curved



**ADSON**  
26-1072-200  
20 cm, 8" Straight  
15 mm x 7.5 mm



1/2  
**BANE**



1/4  
**26-1073-180**  
18 cm, 7"  
Slightly Curved,



**HAKANSSON**  
26-1074-155  
15.5 cm, 6"

# BONE RONGEURS



Hohlmeißelzangen  
Pinzas gubias

Pinces-gouges  
Pinze-sgorbie

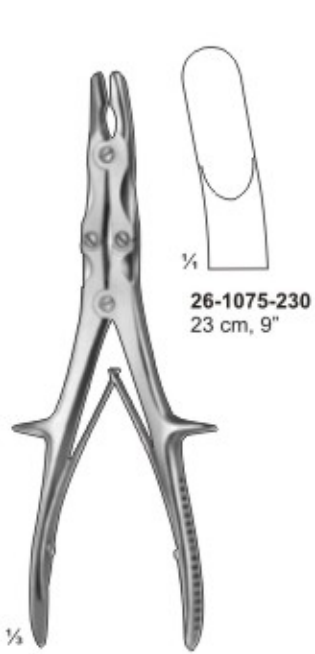

**26-1075-230**  
23 cm, 9"

**STILLE-RUSKIN**

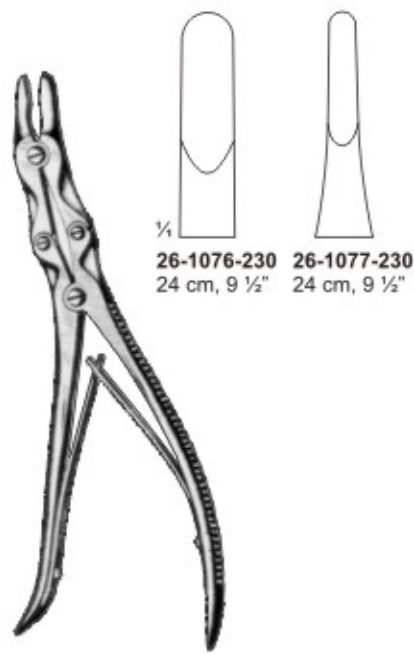

**26-1076-230** **26-1077-230**  
24 cm, 9 1/2" 24 cm, 9 1/2"

**LEKSELL-STILLE**

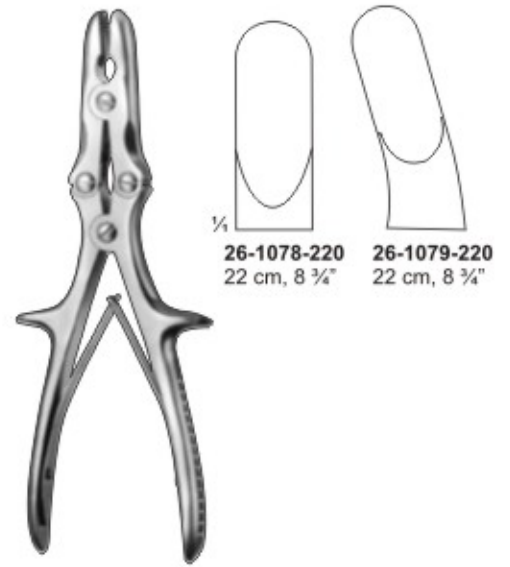

**26-1078-220** **26-1079-220**  
22 cm, 8 3/4" 22 cm, 8 3/4"

**STILLE-LUER**



**26-1080-230** **26-1081-230**  
23 cm, 9" 23 cm, 9"

**ECHLIN / STILLE-LUER**



**BEYER  
RONGEUR**  
**26-1082-180**  
18 cm, 7" curved

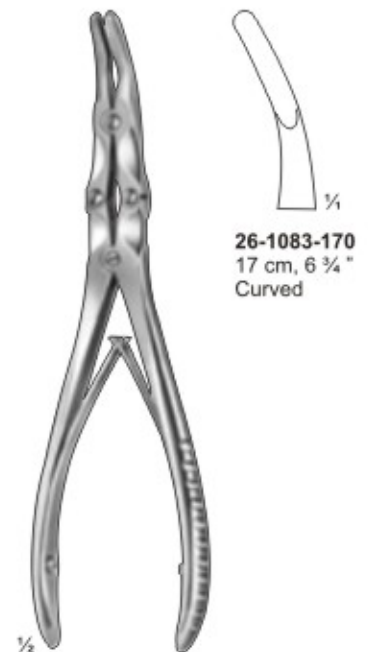

**26-1083-170**  
17 cm, 6 3/4" Curved

**MAYFIELD**





# BONE RONGEURS

Hohlmeißelzangen  
Pinzas gubias

Pinces-gouges  
Pinze-sgorbie

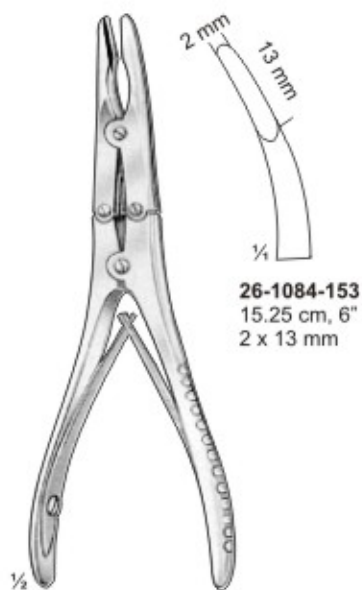

**26-1084-153**  
15.25 cm, 6"  
2 x 13 mm

**KLEINERT-KUTZ**

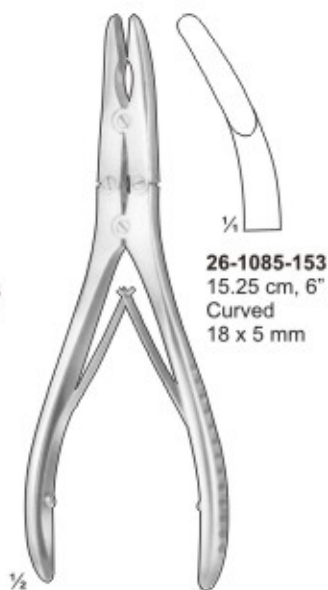

**26-1085-153**  
15.25 cm, 6"  
Curved  
18 x 5 mm

**RUSKIN-MINI**

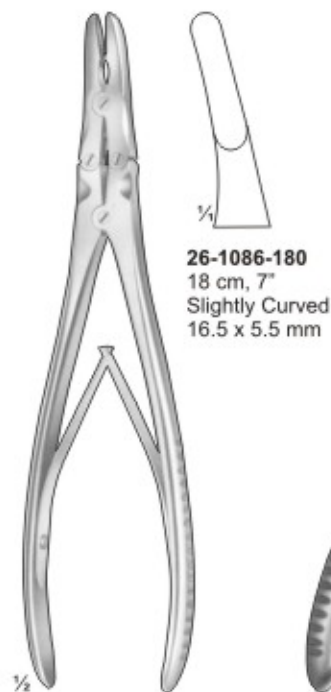

**26-1086-180**  
18 cm, 7"  
Slightly Curved  
16.5 x 5.5 mm

**RUSKIN**

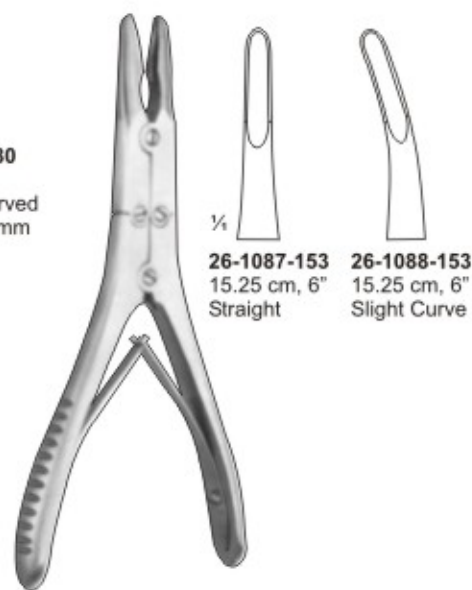

**26-1087-153**  
15.25 cm, 6"  
Straight

**26-1088-153**  
15.25 cm, 6"  
Slight Curve

**BÖHLER**



**26-1089-180**  
18 cm, 7"  
Curved

**BEYER**



**26-1090-180**  
18 cm, 7"  
Slightly Curved

**ZAUFAL-JANSEN**



**26-1091-230**  
22.5 cm, 9"

**SEMB**



**26-1092-230**  
23 cm, 9"  
Duckbill  
17 mm x 6 mm

**STILLE**

# BONE RONGEURS



Hohlmeißelzangen  
Pinzas gubias

Pinces-gouges  
Pinze-sgorbie



**ECHLIN**  
23 cm, 9"



26-1093-230  
2 mm

26-1094-230  
3 mm

26-1095-230  
4 mm



**LEKSELL**  
26-1096-220 3 mm  
26-1097-220 5 mm  
26-1098-220 8 mm  
22 cm, 8 3/4"



**MAYFIELD**  
26-1099-170  
17 cm, 6 3/4"



**RUSKIN RONGEUR**  
26-1100-00  
curved



**MARQUARDT**  
26-1101-200  
20 cm, 8"



## BONE RONGEURS

Hohlmeißelzangen  
Pinzas gubias

Pinces-gouges  
Pinze-sgorbie



**26-1102-230**  
23 cm, 9"  
**26-1103-270**  
27 cm, 10 1/2"  
straight

**STILLE-LUER**  
Rongeur Forceps



**26-1104-230**  
23 cm, 9"  
**26-1105-270**  
27 cm, 10 1/2"  
curved



**STILLE RONGEUR**  
Forceps  
**26-1106-230**  
23 cm, 9"  
Double-Action  
jaws 3mm wide  
Jaws angled to side



**LEKSELL RONGEUR**  
Forceps  
**26-1107-230**  
23 cm, 9"  
Double-Action  
Fully Curved  
Jaw 7mm x 13mm wide



**SAUERBRUCH**  
31 cm, 12 1/4"



**26-1108-310**  
Round  
20 mm



**26-1109-310**  
Straight  
20 mm

# BONE CUTTING FORCEPS

Knochensplitterzangen  
Pinzas cortantes para hueso

Pinces coupantes à os  
Cesoie per ossa



**LISTON BONE  
Cutting Forceps**



**26-1110-140**  
14 cm, 5 1/2"



**26-1111-170**  
17 cm, 6 3/4"



**26-1112-190**  
19 cm, 7 1/2"  
**26-1113-220**  
22 cm, 8 3/4"



**LISTON  
P109-597-000**



**26-1114-140**  
14 cm, 5 1/2"



**26-1115-170**  
17 cm, 6 3/4"



**26-1116-190**  
19 cm, 7 1/2"



**26-1117-220**  
22 cm, 8 3/4"



**MARKWALDER**



**26-1118-200**  
20 cm, 8"



**LITTAUER / LISTON**



**26-1119-150**  
15 cm, 6"  
Straight,



**CLEVELAND-GARDNER**



**26-1120-160**  
16 cm, 6 1/2"



## BONE CUTTING FORCEPS

Knochensplitterzangen  
Pinzas cortantes para hueso

Pinces coupantes à os  
Cesoie per ossa

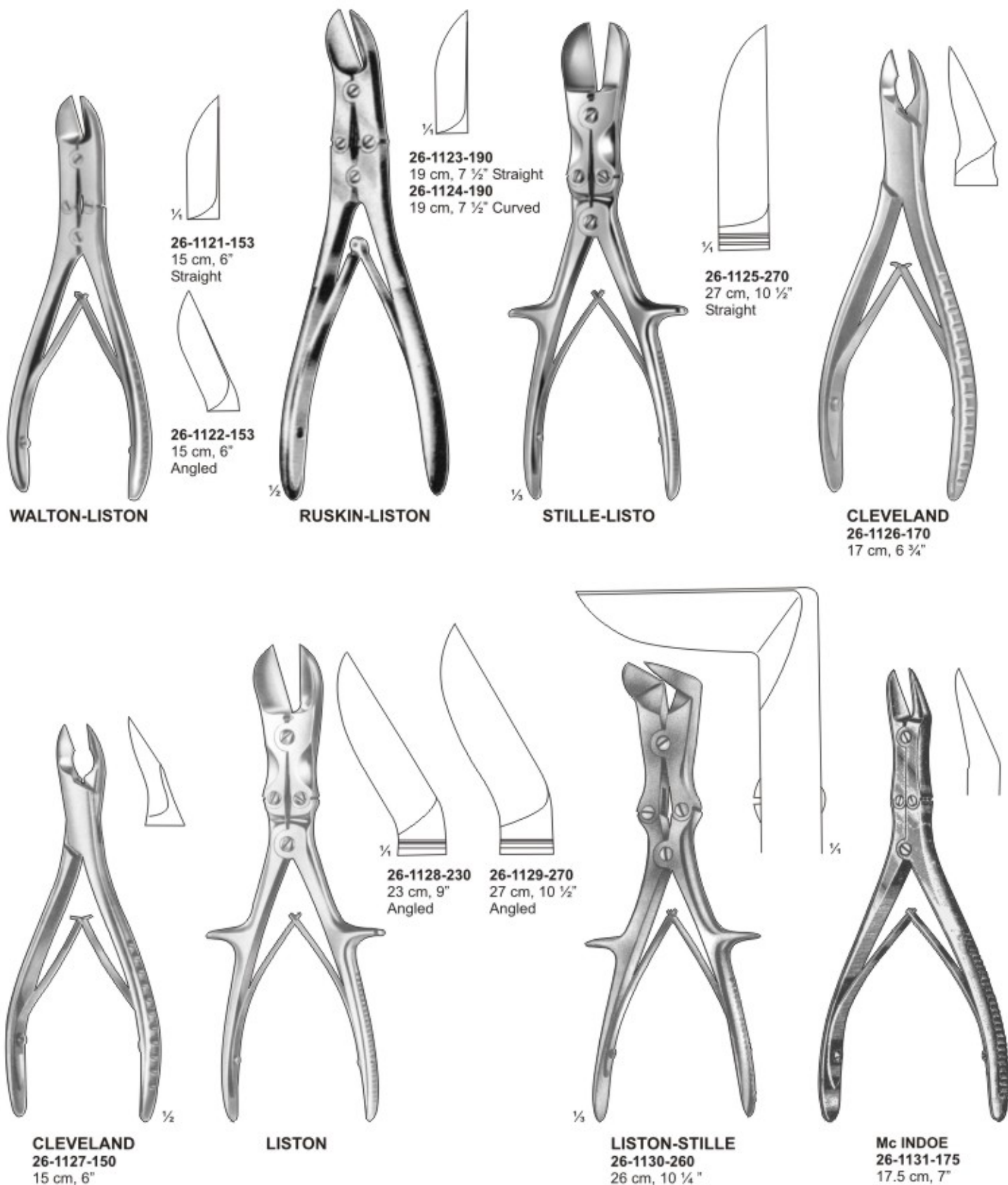

# BONE CUTTING FORCEPS

Knochensplitterzangen  
Pinzas cortantes para hueso

Pinces coupantes à os  
Cesoie per ossa



**HORSLEY**  
Bone Cutting Forceps  
26-1132-250  
25 cm, 10"



**LISTON-KEY (HORSLEY)**  
26-1133-265  
26.5 cm, 10 1/2"  
Angled, 28 mm

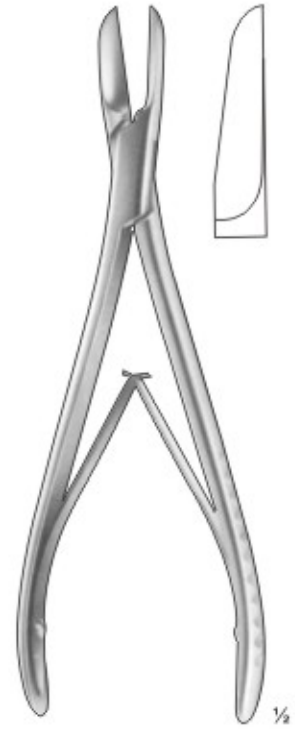

**COTTLE-KAZANJIAN**  
26-1134-190  
19 cm, 7 1/2"

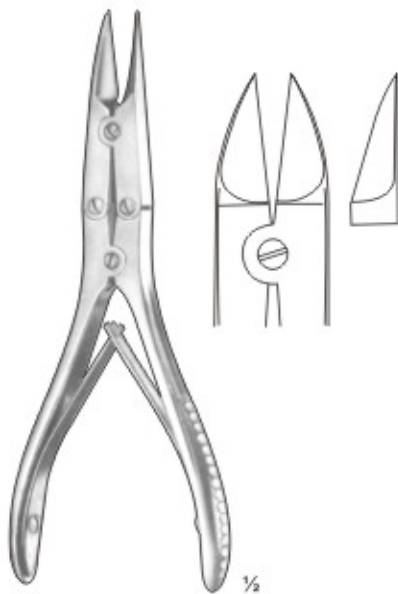

**26-1135-150**  
15 cm, 5 3/4"

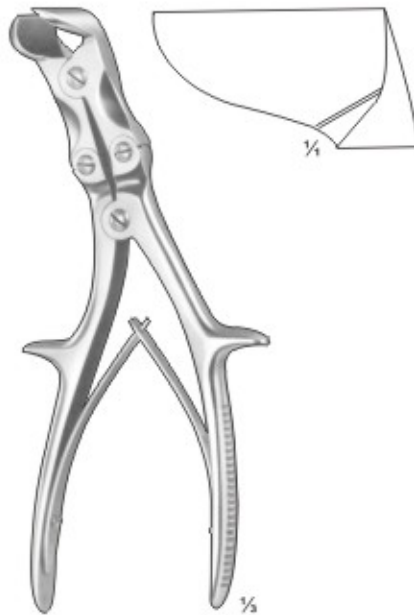

**SEMB**  
26-1136-240  
24 cm, 9 1/2"



**RUSKIN BONE SPLITTING  
FORCEPS**  
26-1137-200  
20 cm, 8", Double-Action



## DRESSING SCISSORS / PLASTER SHEARS

Gipsmesser, Gipssäge, Oszillierende Gipssäge,  
Cuchillos para yeso, Sierra oscillante para yeso

Couteaux pour plâtre, Scies oscillante  
Coltelli per gesso, Sega oscillata per gesso



**GORNEY SEPTAL  
SCISSORS**  
26-1138-197  
19.7 cm, 8"  
double action



**UTILITY SHEARS**  
26-1139-215  
21.5 cm, 8 1/2"  
Serrated blade



**SEUTIN**  
26-1140-230  
23.0 cm, 9"



**WOLFF**  
26-1141-180 18 cm, 7"  
26-1142-240 24 cm, 9 1/2"



**STILLE**  
26-1143-200 20 cm, 8"  
26-1144-230 23 cm, 9"  
26-1145-260 26 cm, 10"  
26-1146-370 37 cm, 14 1/2"



**HENNIG**  
26-1147-280  
28 cm, 11"



**CAPLAN**  
26-1148-220 22 cm, 8 3/4" Straight  
26-1149-220 22 cm, 8 3/4" Curved

**ORTHOPAEDICS WIRE CUTTER**



¼

**26-1150-150**  
15 cm, 6"



¼

**DIAMANT PIN CUTTER**  
**26-1151-160**  
16 cm, 5 ½"

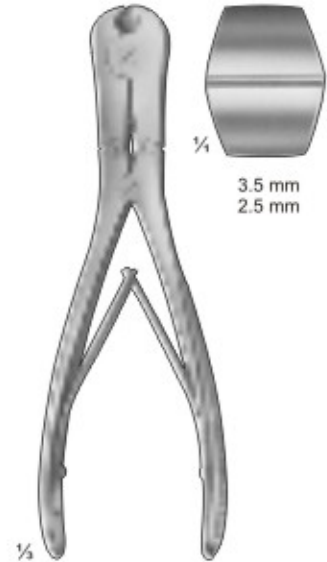

¼

3.5 mm  
2.5 mm

¼

**26-1152-220**  
22 cm, 9 ¾"



¼

**26-1153-320**  
32 cm, 12 ¾"  
3.0 mm, 3.0 mm

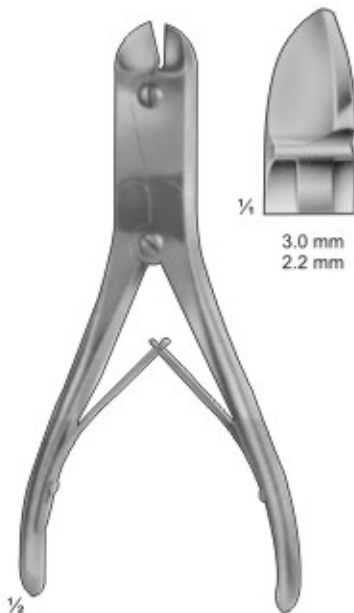

¼

¼

3.0 mm  
2.2 mm

**26-1154-235**  
23.5 cm, 9 ¼"



¼

**26-1155-140**  
14 cm, 5 ½"  
1.2 mm

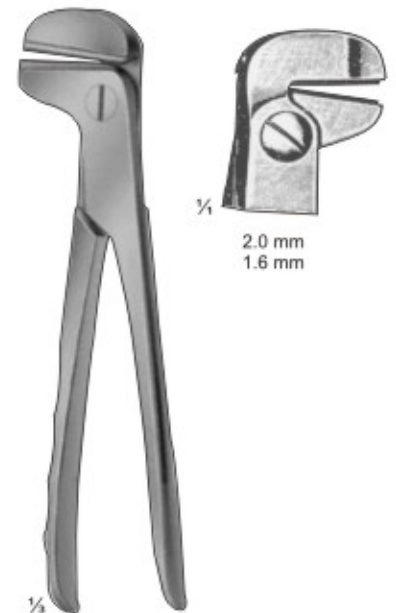

¼

2.0 mm  
1.6 mm

¼

**26-1156-240**  
24 cm, 9 ½"





## FLAT NOSE PLIERS & WIRE CUTTING PLIERS T.C. INSERTED

*Pinces plates, Alicates planos, Flachzangen.*

*Pinces coupantes, Alicates para cortar alambre, Drahtkneifzangen*



**EXTRACTION PLIERS**  
26-1157-180 18 cm, 7"  
26-1158-180 18 cm, 7"



**EXTRACTION PLIERS**  
26-1159-200  
20 cm, 8"



**EXTRACTION PLIERS**  
26-1160-200  
20 cm, 8"

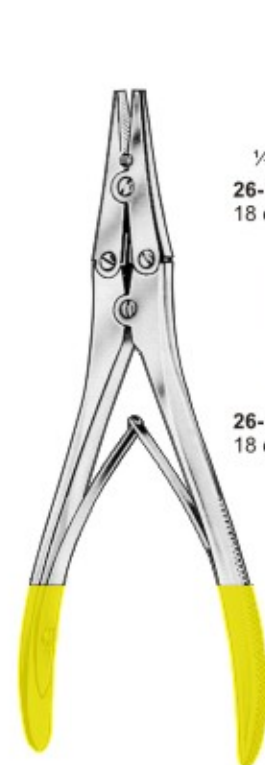

**WIRE CUTTERS**

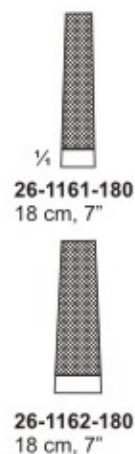

**WIRE CUTTERS**  
26-1163-180  
18 cm, 7"



**WIRE CUTTERS**  
26-1164-180 18 cm, 7"  
26-1165-210 21 cm, 8 1/4"



**WIRE CUTTERS**  
26-1166-180  
18 cm, 7"

# WIRE CUTTING PLIERS T.C INSERTED

*Pinces coupantes, Alicates para cortar alambre, Drahtkneifzangen*



## UNIVERSAL SCISSORS

26-1167-100 10 cm, 4"  
26-1168-120 12 cm, 5"



**WIRE CUTTER**  
26-1169-180  
18 cm, 7"  $\frac{1}{2}$



**WIRE CUTTERS**  
26-1170-180 18 cm, 7"  
26-1171-210 21 cm, 8  $\frac{1}{2}$ "



**WIRE CUTTERS**  
26-1172-140  
14 cm, 5  $\frac{1}{2}$ "  $\frac{1}{4}$

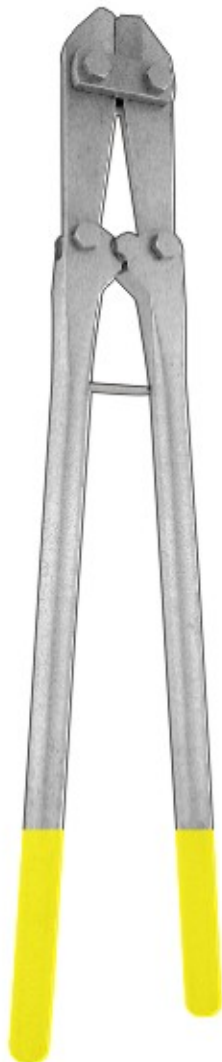

**WIRE CUTTERS**  
26-1173-460 46 cm, 18"  
26-1174-560 56 cm, 22"



**WIRE CUTTERS**  
26-1175-220  
22 cm, 8  $\frac{3}{4}$ "  $\frac{1}{2}$

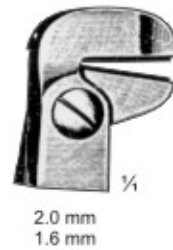

2.0 mm  
1.6 mm  $\frac{1}{4}$



26-1176-240  
24 cm, 9  $\frac{1}{2}$ "  $\frac{1}{2}$



# E.N.T. SURGERY

---



# EAR SPECULA

Ohrspekula  
Espéculos Auriculares

Spéculms Auriculares  
Specoli Auricolari



2.0 3.0 3.5 4.0 4.5 5.0 6.0 6.5 7.0 7.5 mm Ø



### BOUCHERON

27-001-001 Set of 4  
27-002-002 3.5 mm  
27-003-003 4.5 mm  
27-004-004 5.5 mm  
27-005-005 6.5 mm



### PLOITZER

27-006-001 Set of 4  
27-007-002 2 mm  
27-008-003 3 mm  
27-009-004 4 mm  
27-010-005 5 mm



### HARTMANN for children

27-011-001 Set of 3  
27-012-002 2 mm  
27-013-003 3.5 mm  
27-014-004 5 mm



### HARTMANN Set of 4, For Adults

327-015-001 4.0 mm  
327-016-002 5.0 mm  
327-017-003 6.0 mm  
327-018-004 7.5 mm



### ZOLLNER Set of 6, Alu Black

27-019-001 5.3 x 6.5 mm  
27-020-002 7.5 x 8.5 mm  
27-021-003 6.5 x 7.5 mm  
27-022-004 8.5 x 9.5 mm  
27-023-006 9.5 x 10.5 mm  
27-024-007 10.5 x 11.5 mm



### GRUBER AURAL SPECULA

Black finish, diam, 38 mm

27-025-001 Set of 4  
27-026-002 3 mm  
27-027-003 4 mm  
27-028-004 5 mm  
27-029-005 7 mm



### ROSEN

Black finish, slotted round ends 35 mm

27-030-001 Set of 4  
27-031-002 3 mm  
27-032-003 4 mm  
27-033-004 5 mm  
27-034-005 7 mm



### ROSEN

slotted round ends  
Black finish, 35 mm

27-035-001 Set of 4  
27-036-002 4 mm  
27-037-003 5 mm  
27-038-004 6 mm  
27-039-005 7 mm



### TUMARKIN

Tapered Slot

27-040-001	Size	Set of 8
27-041-002	0	4.5 mm
27-042-003	1	6.5 mm
27-043-004	2	7.0 mm
27-044-005	3	7.5 mm
27-045-006	4	8.0 mm
27-046-007	5	8.5 mm
27-047-008	6	9.0 mm
27-048-009	7	11. mm



# DIAGNOSTIC PRODUCTS

Diagnostikprodukte  
produits diagnostiques

Prodotti diagnostici  
Productos de diagnóstico



27-049-001

27-053-005  
Rubber Bulb with rubber  
tube and connection cone



27-050-002  
Ear Speculum,  
Ø 6.5 mm



27-051-003  
Ear Speculum,  
Ø 7 mm



27-052-004  
Ear Speculum,  
Ø 8 mm

## SIEGLE

Single Part:

27-049-001 to 27-053-005 Diagnostic Head Complete Set  
Aural magnifier, anastigmatic,  
complete with:

27-049-001 1 diagnostic head

27-050-002 to 27-052-004 3 ear specula

27-053-005 1 rubber bulb with rubber tube and  
connection cone

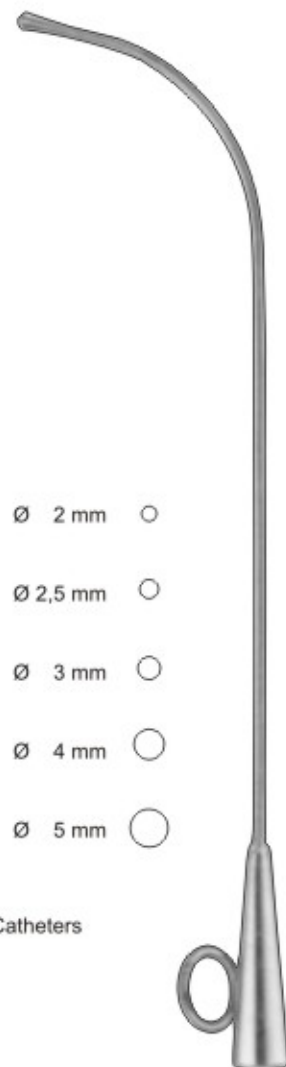

27-059-001 Ø 2 mm ○

27-060-002 Ø 2,5 mm ○

27-061-003 Ø 3 mm ○

27-062-004 Ø 4 mm ○

27-063-005 Ø 5 mm ○

Hartmann  
Eustachian Catheters



## POLITZER

27-054-001  
Air Douche, with  
metal mount



## Metal Nasal Tips

27-055-002 Ø 18 mm  
27-056-003 Ø 21 mm  
27-057-004 Ø 23 mm



## 27-058-005

Metal Connector,  
eustachian catheter to  
Politzer air douche

# TUNING FORKS



Stimmgabeln  
Diapasones

Diapasons  
Diapason



**HARTMANN /  
FRENCH**  
27-064-128  
C 128



**LUCAE**  
27-065-128  
C 128  
Variable up to h  
(= Engl. B)



**HARTMANN**  
27-066-128  
C 128  
Variable up to h  
(= Engl. B)

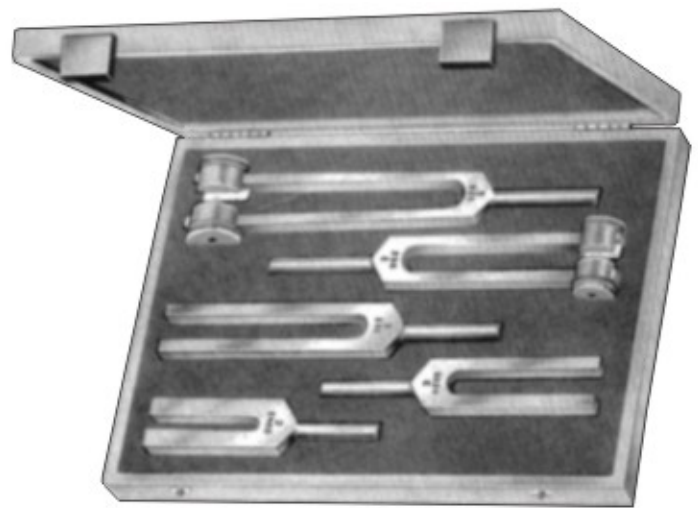

27-068-000 = Set 5

- 27-069-0128 C 128
- 27-070-0256 C 256
- 27-071-0512 C 512
- 27-072-1024 C 1024
- 27-073-2048 C 2048

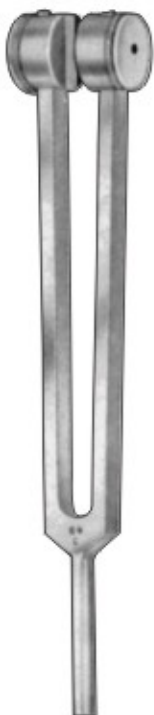

27-067-064  
C 64



27-069-128  
C 128

Aluminum



27-070-256  
C 256

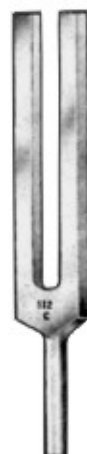

27-071-512  
C 512



27-072-1024  
C 1024



27-073-2048  
C 2048



27-074-4096  
C 4096



# TUNING FORKS

Stimmgabeln  
Diapasones

Diapasons  
Diapason



HARTMANN      LUCAE      HARTMANN-FRENCH

C <sup>2</sup>	16			27-087-016
C <sup>1</sup>	32			27-088-032
C	64			27-089-064
C	128 c	27-075-128	27-081-128	27-090-128
C <sup>1</sup>	256 c <sup>1</sup>	27-076-256	27-082-256	27-091-256
C <sup>2</sup>	512 c <sup>2</sup>	27-077-512	27-083-512	
C <sup>3</sup>	1024 c <sup>3</sup>	27-078-1024	27-084-1024	
C <sup>4</sup>	2048 c <sup>4</sup>	27-079-2048	27-085-2048	
C <sup>5</sup>	4096 c <sup>5</sup>	27-080-4096	27-086-4096	

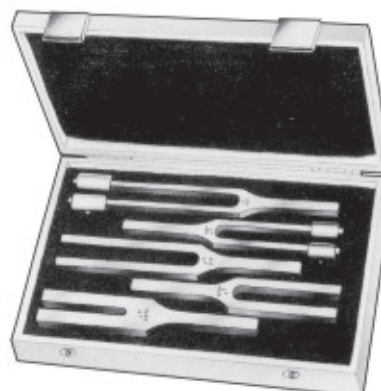

**HARTMANN**  
27-092-000 = Set 6

27-075-128	128 C
27-076-256	256 C <sup>1</sup>
27-077-512	512 C <sup>2</sup>
27-078-1024	1024 C <sup>3</sup>
27-079-2048	2048 C <sup>4</sup>
27-080-4096	4096 C <sup>5</sup>

**LUCAE**  
27-093-000 = Set 6

27-081-128	128 C
27-082-256	256 C <sup>1</sup>
27-083-512	512 C <sup>2</sup>
27-084-1024	1024 C <sup>3</sup>
27-085-2048	2048 C <sup>4</sup>
27-086-4096	4096 C <sup>5</sup>

**HARTMANN-FRENCH**  
27-094-000 = Set 7

27-087-016	16 C <sup>2</sup>
27-088-032	32 C <sup>2</sup>
27-089-064	64 C
27-090-128	128 C
27-091-256	256 C <sup>1</sup>



**RYDEL-SEIFFER**  
27-095-001  
C 65 / C 128  
With Clamps = C 64  
Without Clamps = C 128



27-096-001



**KOENIG**  
27-097-001  
A 109  
Variable up to g



27-098-001  
a<sup>1</sup> 109

# TYMPANUM NEEDLE



Trommelfellnadeln,  
Agujas Para Tímpano,

Aiguilles Pour Le Tympan,  
Aghi Per Timpano,

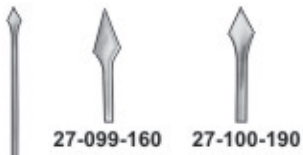

27-099-160 27-100-190



## LUCAE

**27-099-160**  
for children, 16 cm, 6 1/2"  
**27-100-190**  
for adults, 19 cm, 7 1/2"  
Tympanum Perforators, bayonet-shaped  
**27-101-180**  
for children, 18 cm, 7"  
Tympanum Perforator, bayonet-shaped,  
handle 90 angled to the lancet



## AGNEW

**27-102-190**  
Tympanum Perforator, angular  
19 cm, 7 1/2"



## POLITZER

**27-103-165**  
16.5 cm, 6 1/2"

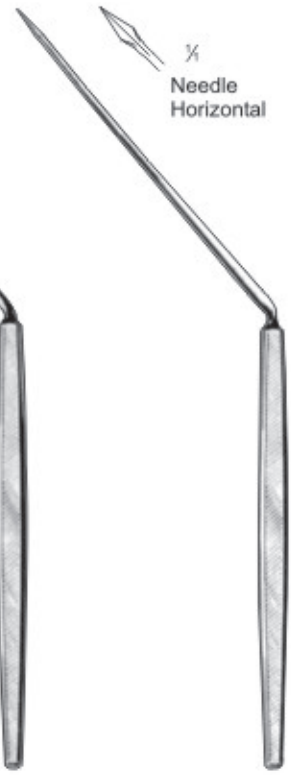

## POLITZER

**27-104-165**  
16.5 cm, 6 1/2"



## POLITZER

**27-105-160**  
16 cm, 6 1/2"



## BUCK

**27-106-150**  
15 cm, 6"



## SEXTON

**27-107-180**  
18 cm, 7"



## SEXTON

**27-108-170**  
17 cm, 6 3/4"



## GERZOG-SEXTON

**27-109-170**  
17 cm, 6 3/4"



## POLITZER

**27-110-160**  
16 cm, 6 1/2"





# TYMPANUM NEEDLE, EAR CURETTES

Trommelfellnadeln, Ohrküretten  
Agujas Para Timpano, Curettes Auriculaires

Aiguilles Pour Le Tympan, Curettes Auriculaires  
Aghi Per Timpano, Cuette Auricolari



**BARBARA**  
27-111-165

1/4

25°

- 0.3 mm 27-115-165
- 0.6 mm 27-116-165
- 1.0 mm 27-117-165
- 1.2 mm
- 1.5 mm
- 2.0 mm
- 2.5 mm

27-112-165

45°

- 27-118-165
- 27-119-165
- 27-120-165
- 27-121-165
- 27-122-165
- 27-123-165
- 27-124-165

27-113-165

90°

- 27-125-165
- 27-126-165
- 27-127-165
- 27-128-165
- 27-129-165
- 27-130-165
- 27-131-165

**ROSEN**  
27-114-165

- 27-132-165
- 0.5 mm 27-133-165
- 1.0 mm



**LEMPERT**  
17 cm, 6 1/2"

27-134-170  
2 mm

27-135-170  
3 mm

27-136-170  
4 mm

27-137-170  
5 mm



**SHAPLEIGH**  
13 cm, 5 1/4"

27-138-130

27-139-130

**BARBARA**



**BUCK**  
16.5 cm, 6 1/2"



- |                     |                     |                     |                     |
|---------------------|---------------------|---------------------|---------------------|
| 27-140-165<br>Blunt | 27-142-165<br>Blunt | 27-144-165<br>Blunt | 27-146-165<br>Blunt |
| 27-141-165<br>Sharp | 27-143-165<br>Sharp | 27-145-165<br>Sharp | 27-147-165<br>Sharp |
| 27-148-165<br>Blunt | 27-150-165<br>Blunt | 27-152-165<br>Blunt | 27-154-165<br>Blunt |
| 27-149-165<br>Sharp | 27-151-165<br>Sharp | 27-153-165<br>Sharp | 27-155-165<br>Sharp |



**LANGENBECK**  
27-156-130  
13 cm, 5 1/4"



**BARTH**  
27-157-180  
18 cm, 7"



**JANDEN**  
27-158-150  
15 cm, 6"

# EAR HOOKLETS, TYMPANUM NEEDLE



Ohrhäkchen, Trommelfellnadeln  
Ganchitos Auriculares, Agujas Para Tímpano

Crochets Auriculaires, Aiguilles Pour Le Tympan  
Uncini Auricolari, Aghi Per Timpano

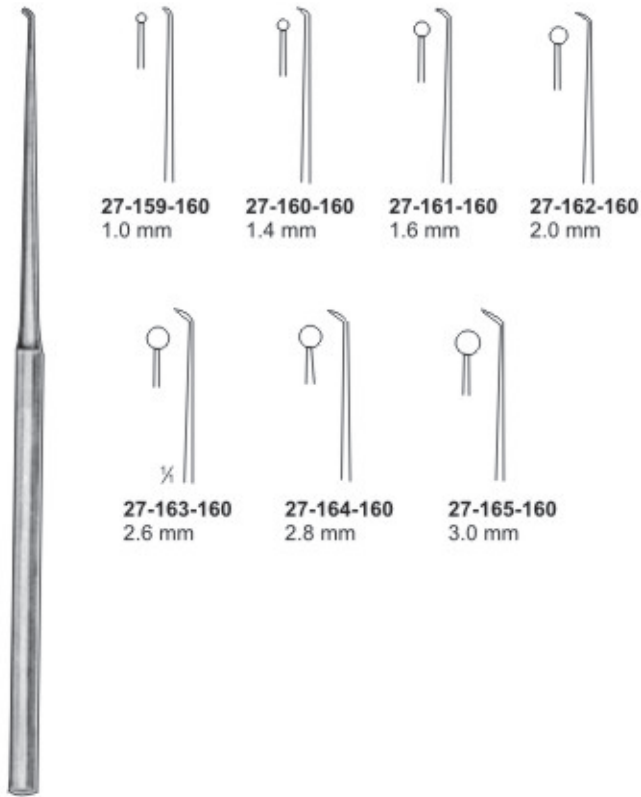

**ROSEN**  
16 cm, 6 1/4"

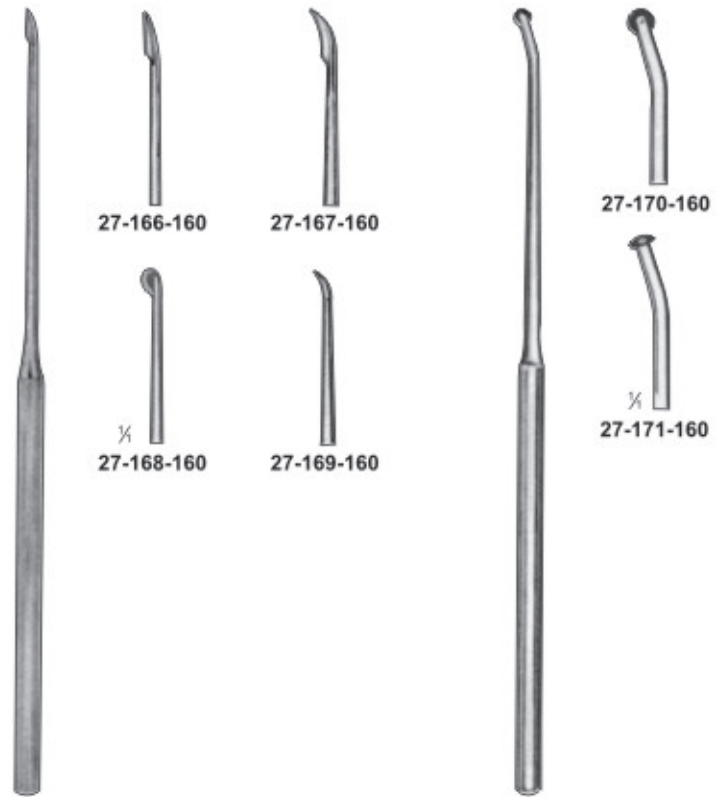

**PLESTER**  
16 cm, 6 1/4"

**SCHUKNECHT**  
16 cm, 6 1/4"

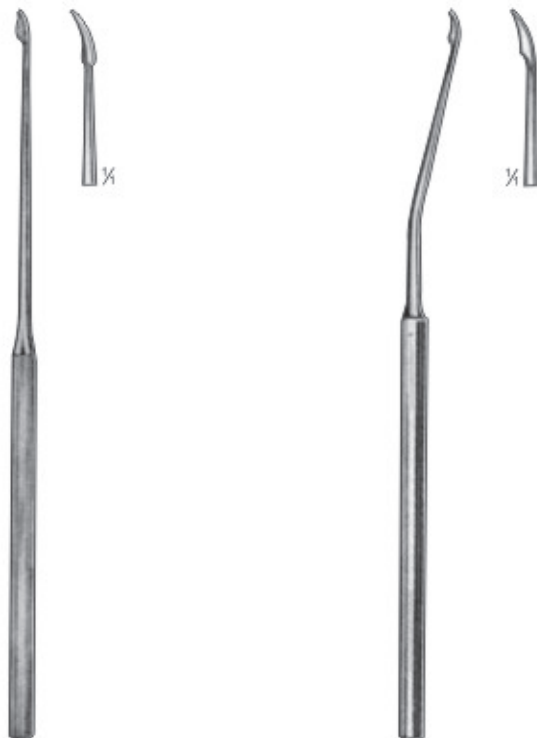

**SCHUKNECHT**  
27-172-160  
16 cm, 6 1/4"

**SCHUKNECHT**  
27-173-160  
16 cm, 6 1/4"



**BILLEAU**  
16.5 cm, 6 1/2"

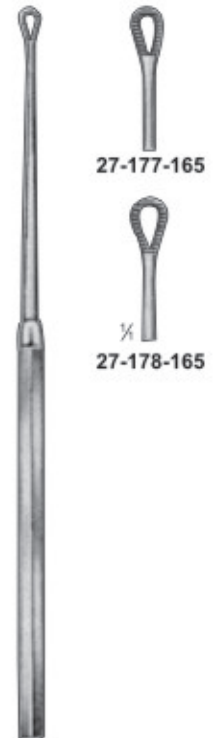

**SNELLEN**  
16.5 cm, 6 1/2"



# EAR HOOKLETS, TYMPANUM NEEDLE

Ohrhäkchen, Trommelfellnadeln  
Ganchitos Auriculares, Agujas Para Timpano

Crochets Auriculaires, Aiguilles Pour Le Tympan  
Uncini Auricolari, Aghi Per Timpano



**GROSS**  
27-179-165  
16.5 cm, 6 1/2"



**HARTMANN**  
27-180-165  
16.5 cm, 6 1/2"



**ZAUFAL**  
27-181-165  
16.5 cm, 6 1/2"



**WAGENER**  
14 cm, 5 1/2"

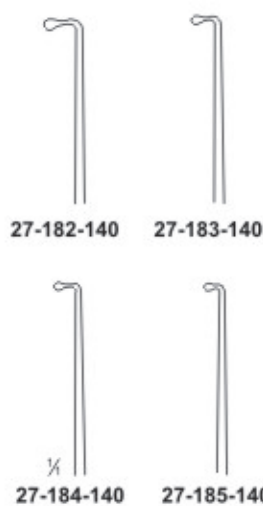

**LUCAE**  
14 cm, 5 1/2"



**FISCH**  
18 cm, 7"

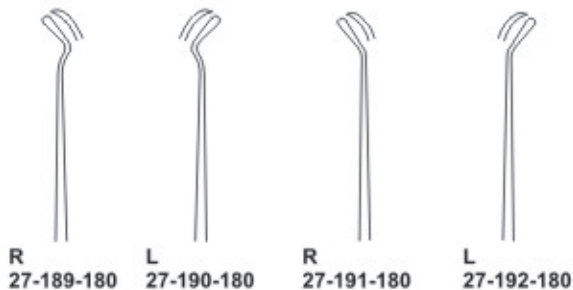

**ROSEN**  
18 cm, 7"

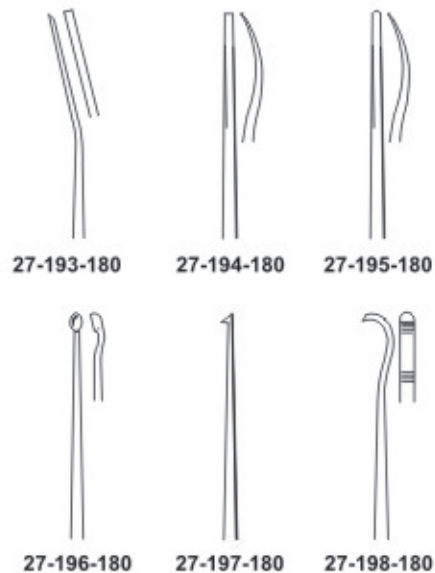

# EAR POLYPUS FORCEPS



Ohrpolypenzangen  
Pinzas Para Pólipos Auriculares

Pinces Pour Polyypes Auriculares  
Pinze Per Polipi Auricolari

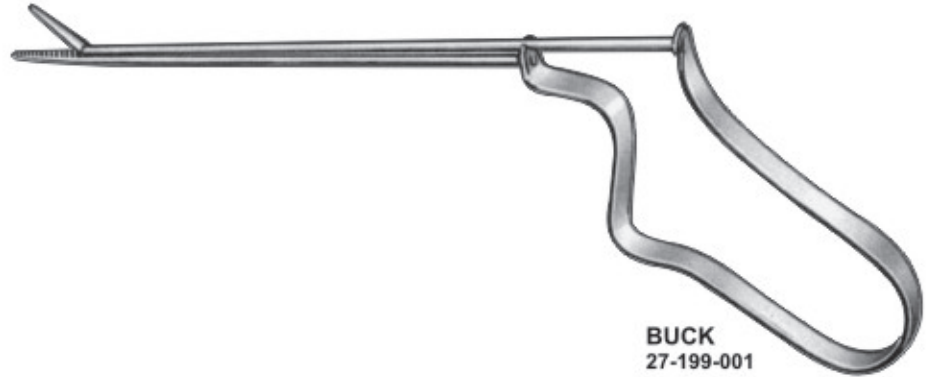
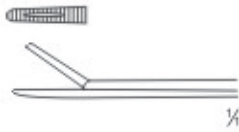

**BUCK**  
27-199-001



**QUIRE**  
27-200-120  
12 cm, 4 3/4"

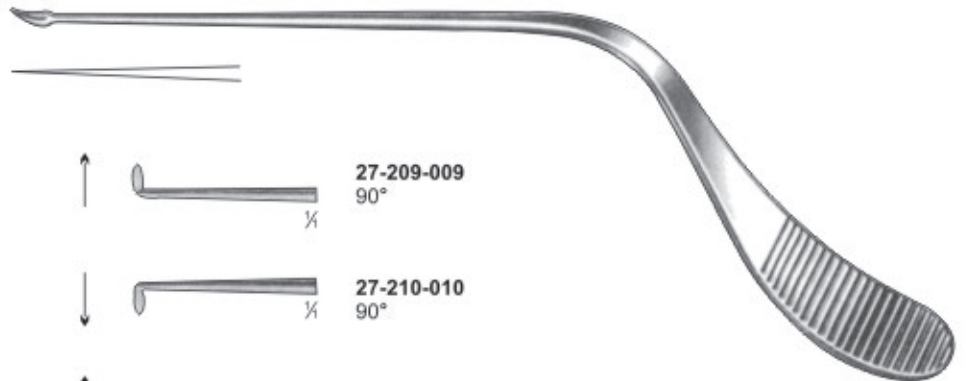

**ZÖLLNER**  
27-218-000



**27-201-001**  
45°/0.5 mm



**27-202-002**  
45°/1.0 mm



**27-203-003**  
45°/0.5 mm



**27-204-004**  
45°/1.0 mm



**27-205-005**  
90°/0.5 mm



**27-206-006**  
90°/0.5 mm



**27-207-007**  
90°/1.0 mm



**27-208-008**  
90°/1.0 mm



**27-209-009**  
90°



**27-210-010**  
90°



**27-211-011**



**27-212-012**



**27-213-013**



**27-214-014**



**27-215-015**



**27-216-016**



**27-217-017**



# EAR SYRINGES, ALLIGATOR EAR FORCEPS

Ohrspritzen, alligator-ohrfaßzangen  
Seringues à oreilles, Pinces crocodiles à oreilles

Siringhe per orecchi, Pinze alligatore per orecchi  
Jeringas para el oído, Pinzas de boca de cocodrilo para el oído



**REINER**  
27-219-001  
Tip Only



**REINER**  
27-220-002  
Tip Only



27-221-003  
Shield



27-222-000 50CC Complete  
75CC Complete  
27-223-000 100CC Complete  
150CC Complete  
With Tip & Shield



**HARTMANN-WULLSTEIN**  
27-224-085



**HARTMANN-WULLSTEIN**  
27-225-085



**HARTMANN**  
27-226-085  
27-227-140



**HARTMANN**  
27-228-085  
27-229-140



**HARTMANN-NOYES**  
27-230-085



**DUCKBILL**  
27-231-085



**WEINGÄRTNER**  
27-232-085



**HARTMANN**  
27-233-085 = 2.0 mm  
27-234-140 = 2.5 mm  
27-235-165 = 3.0 mm



**HARTMANN**  
27-236-085 = 2.0 mm  
27-237-140 = 2.5 mm  
27-238-165 = 3.0 mm



**STRÜMPEL**  
27-239-085



**HARTMAN**  
27-240-085



**HARTMANN**  
27-241-085



**HARTMANN-HOFFMANN**  
27-242-085

# MICRO EAR FORCEPS



Mikro-Ohrzängchen  
Micro Pinzas Auriculares

Micro Pincès Auriculaires  
Micro Pinze Auricolari

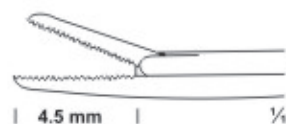

**27-243-080**  
8 cm, 3"  
Straight-Serrated  
4.5 x 0.8 mm

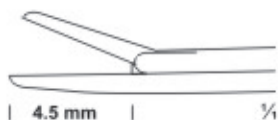

**27-244-080**  
8 cm, 3"  
Straight-Smooth  
4.5 x 0.8 mm

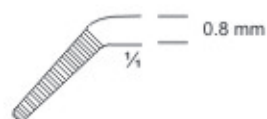

**27-245-080**  
left

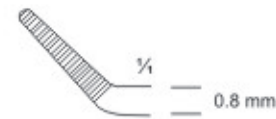

**27-246-080**  
right

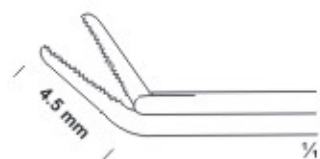

**27-247-080**  
curved up

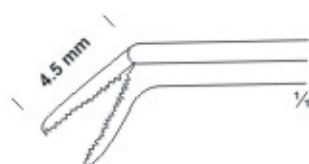

**27-248-080**  
curved down

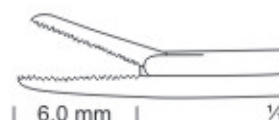

**27-249-080**  
8 cm, 3"  
Straight-Serrated  
6 x 0.8 mm

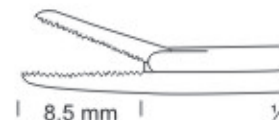

**27-250-080**  
8 cm, 3"  
Straight-Serrated  
8.5 x 0.8 mm

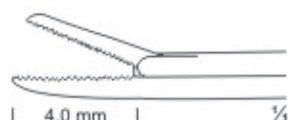

**27-251-080**  
8 cm, 3"  
Straight-Serrated  
4 x 0.6 mm

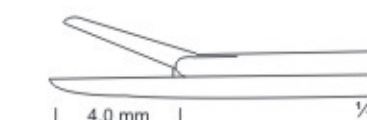

**27-252-080**



**27-253-001**  
7.5 cm, 3"  
With Stylus  
1.0 mm



**27-254-002**  
7.5 cm, 3"  
With Stylus  
1.5 mm



**27-255-003**  
7.5 cm, 3"  
With Stylus  
2.0 mm



MICRO-EAR FORCEPS



## MICRO EAR FORCEPS, MASTOID RONGEURS

Mikro-Ohrzängchen, Ohr-Knochenstanzen

Micro Pinzas Auriculares, Pinzas Cortantes Para Huesos

Micro Pincas Auriculares, Ostéotomes Emporte-pièces

Micro Pinze Auricolari, Pinze Osteotmi

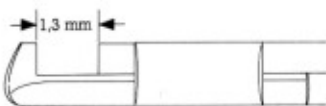

27-256-060  
left

27-257-060  
right

HOUSE-DIETER



27-258-060  
left

27-259-060  
right

HOUSE-DIETER



∩ X 1 mm

∩ X 2 mm

∩ X 3 mm

**CITELLI**

27-260-060 6 cm, 2 1/2"

27-261-060 6 cm, 2 1/2"

27-262-060 6 cm, 2 1/2"

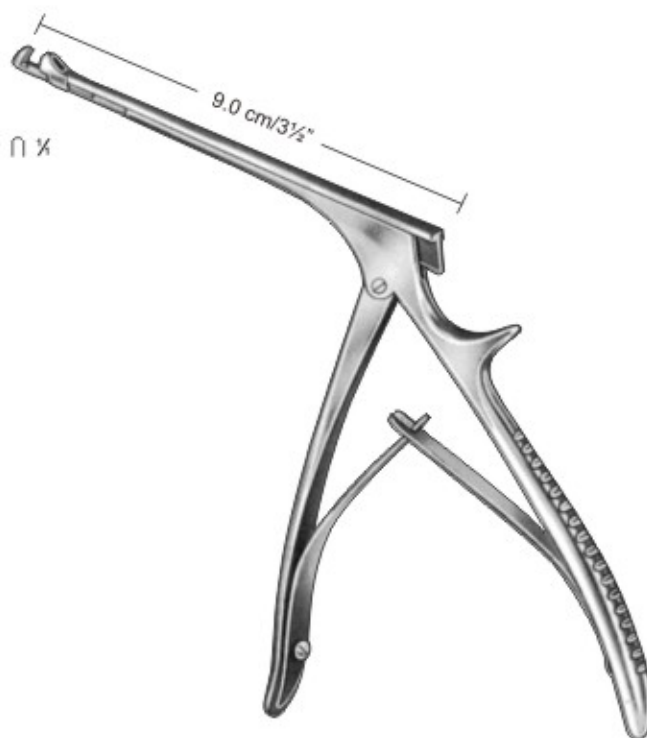

∩ X

**BEYER**

27-263-090

9 cm, 3 1/2"

# MICRO EAR FORCEPS, MASTOID RONGEURS



Mikro-Ohrzängchen, Ohr-Knochenstanzen  
 Micro Pinzas Auriculares, Pinzas Cortantes Para Huesos

Micro Pincas Auriculaires, Ostéotomes Emporte-pièces  
 Micro Pinze Auricolari, Pinze Osteotmi



**WULLSTEIN**

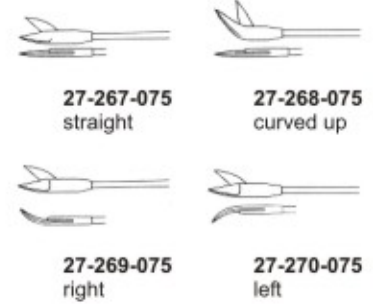
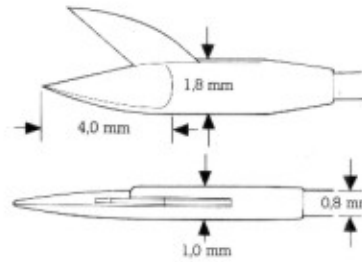
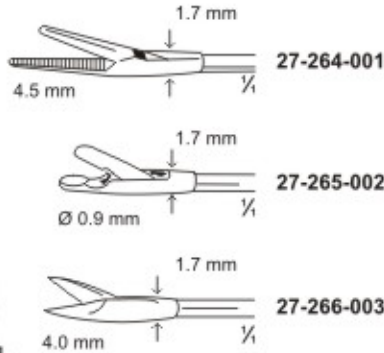

**27-271-001**  
 Micro scissor  
 straight, sharp / sharp



**BELLUCCI 27-272-002**  
 Micro scissor  
 curved up, blunt / blunt



**BELLUCCI 27-273-003**  
 Micro scissor  
 curved to the left,  
 sharp / sharp



**BELLUCCI 27-274-004**  
 Micro scissor  
 curved to the right,  
 sharp / sharp



**BELLUCCI 27-275-005**  
 Micro scissor  
 horizontal cutting

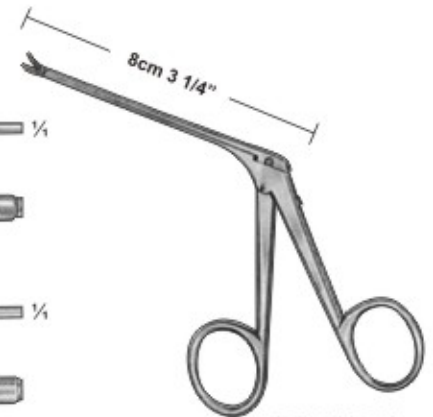

**BELLUCCI**  
 8 cm, 3 1/4"





# MICRO EAR FORCEPS

Mikro-Ohrzängchen  
Micro Pinzas Auriculares

Micro Pincés Auriculaires  
Micro Pinze Auricolari



**27-276-080**  
8 cm, 3 1/4"  
Straight

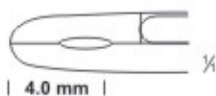

| 4.0 mm |

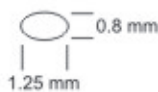

**27-277-080**  
8 cm, 3 1/4"  
Curved right



**27-279-080**  
8 cm, 3 1/4"  
Curved left



**27-278-080**  
8 cm, 3 1/4"  
Curved up



**27-279-080**  
8 cm, 3 1/4"  
Curved down

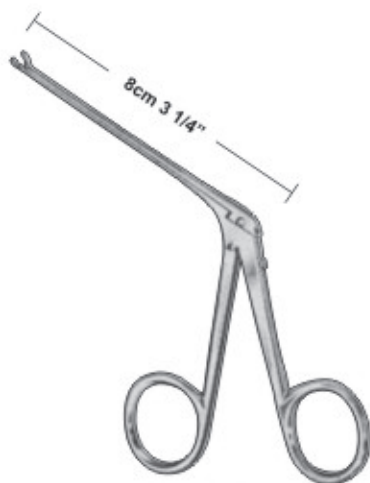
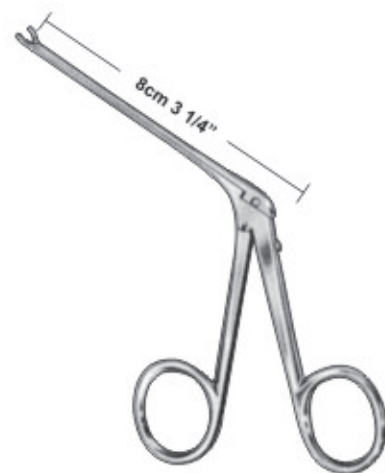

**CRURA-NIPPER**  
**27-280-080**  
8 cm, 3 1/4"



**27-282-080**  
8 cm, 3 1/4"  
0.8 x 3.5 mm



**27-283-080**  
8 cm, 3 1/4"  
0.8 x 6.0 mm



**McGEE**  
**27-281-080**  
8 cm, 3 1/4"

# EAR FORCEPS



Ohrpoinzetten  
Pinzas Auriculares

Pinces Auriculaires  
Pinze Auricolari



**TROELTSCH**  
27-284-110  
11 cm, 4 1/2"



**TROELTSCH**  
27-285-130  
13 cm, 5"



**TROELTSCH**  
27-286-120  
12 cm, 5 1/4"



**LUCAE**  
27-287-140  
14 cm, 5 1/2"



**JANSEN**  
27-288-160  
16 cm, 6 1/4"



**TYDINGS TONSIL  
SEIZING FORCEPS**  
27-289-184  
Two-prong jaws. With catch.  
18.4 cm, 7 1/4"



**TIVNEN TONSIL  
SEIZING FORCEPS**  
27-290-216  
Guard on lock prevents  
over-riding of 3 x 3 prongs.  
21.6 cm, 8 1/2"



# NASAL SPECULUM

Nasenspekula  
Espéculos Nasales

Spéculums Nasaux  
Specoli Nasali



**KILLIAN**  
13 cm, 5 1/4"

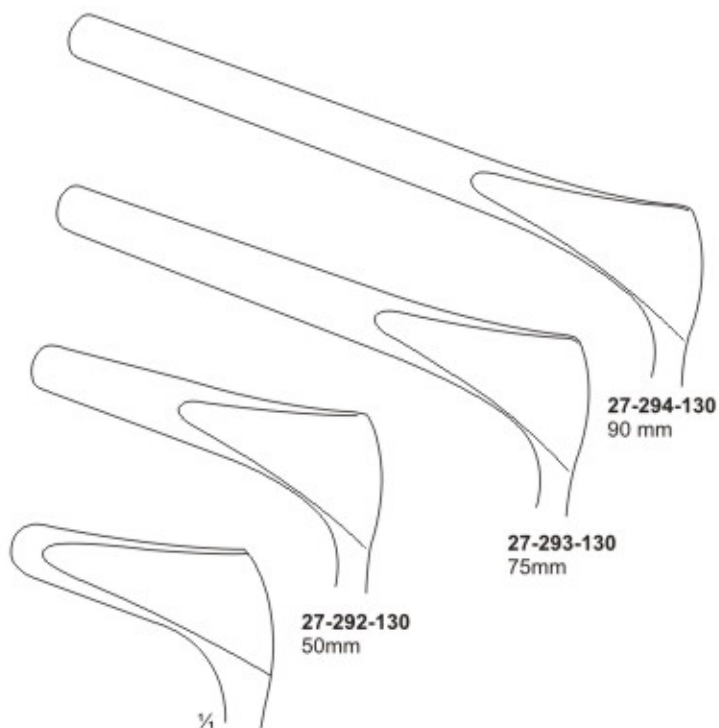

**27-291-130**  
35 mm

**27-292-130**  
50mm

**27-293-130**  
75mm

**27-294-130**  
90 mm



**MODIFIED WIEN**

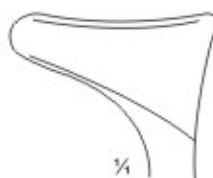

**27-295-130**  
13.0 cm, 5 1/4"  
2.5 cm Tip



**27-296-130**  
13.25 cm, 5 1/4"  
3 cm Tip

With Fixing Screw



**COTTLE**  
27-297-150  
15 cm, 6"

# NASAL SPECULUM

Nasenspekula  
Espéculos Nasaes

Spéculums Nasaux  
Specoli Nasali



**COTTLE**  
15 cm, 6"

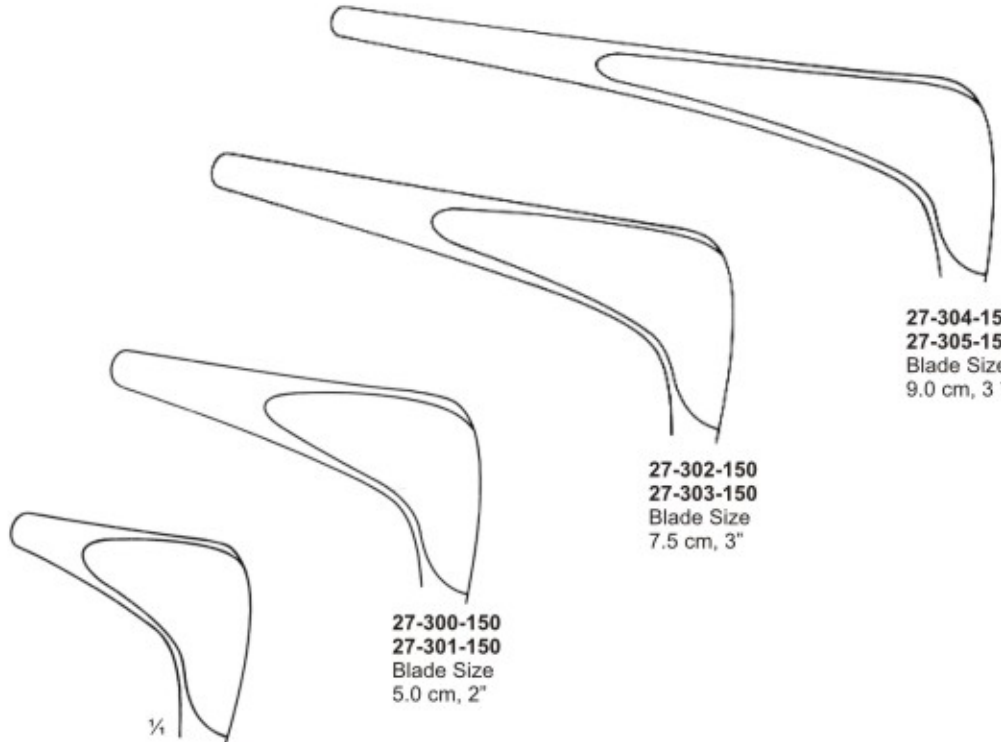

**27-304-150**  
**27-305-150**  
Blade Size  
9.0 cm, 3 1/2"

**27-302-150**  
**27-303-150**  
Blade Size  
7.5 cm, 3"

**27-300-150**  
**27-301-150**  
Blade Size  
5.0 cm, 2"

1/4

**27-298-150**  
**27-299-150**  
Blade Size  
3.5 cm, 1 1/2"

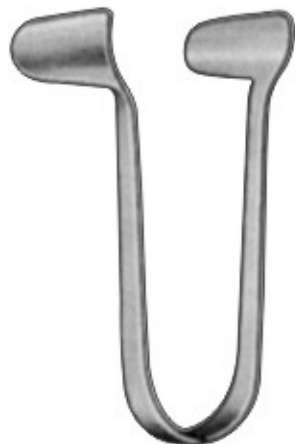

**THUDICHUM**  
(Golfsmith)



**27-306-065**  
6.5 cm, 2 1/2"



**27-307-065**  
6.5 cm, 2 1/2"



**27-308-065**  
6.5 cm, 2 1/2"

1/4



**VOLTOLINI**  
(Duplay)



**27-309-001**



**27-310-002**



1/4  
**27-311-003**



# NASAL SPECULUM

Nasenspekula  
Especulos Nasaes

Spéculums Nasaux  
Specoli Nasali



27-312-135  
13.5 cm, 5 1/2"

TIECK-HALLE

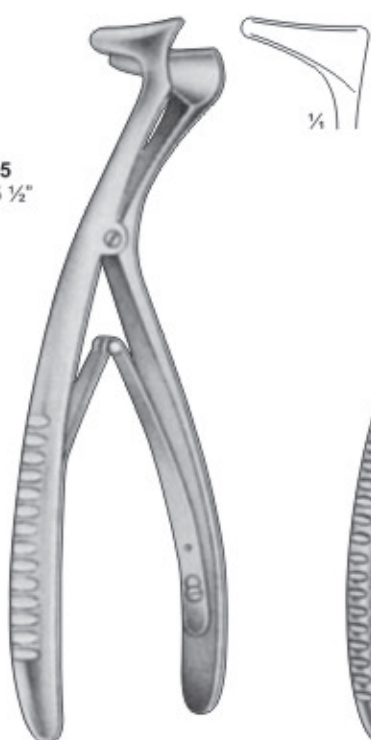

BECKMANN  
27-313-130  
13 cm, 5"

BECKMANN



BECKMANN  
15 cm, 6"

BECKMANN



27-314-150



27-315-150



27-316-150



HARTMANN-HALLE  
15 cm, 6"

HARTMANN-HALLE

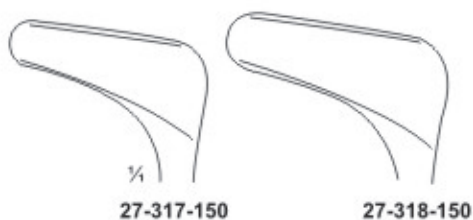

27-317-150

27-318-150



27-319-150



HARTMANN  
15 cm, 6"

HARTMANN

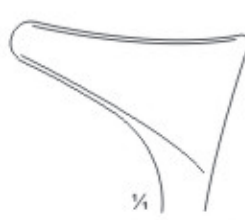

27-320-150

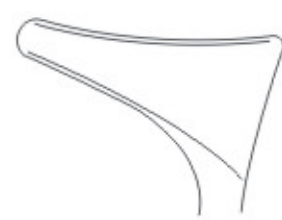

27-321-150

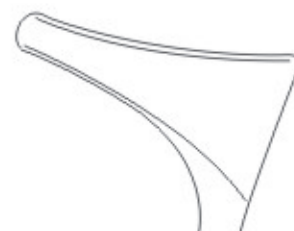

27-322-150

# NASAL SPECULUM

Nasenspekula  
Espéculos Nasaes

Spéculums Nasaux  
Specoli Nasali



**MODIFIED WIEN**  
14.5 cm, 5 3/4"

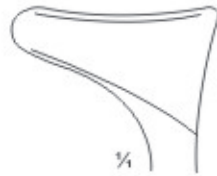

27-323-145  
2.5 cm Tip



27-324-145  
3 cm Tip



**VIENNA NASAL SPECULUM**  
27-325-140 - Infant  
27-326-140 - Child  
27-327-140 - Adult  
14 cm, 5 1/2"



**HALLE NASAL SPECULUM**  
27-328-140 - Infant  
27-329-140 - Adult  
14 cm, 5 1/2"



**VIENNA NASAL SPECULUM**  
27-330-140 - Adult  
14 cm, 5 1/2"



**COTTLE SEPTAL SPECULUM**  
27-331-150 15 cm, 6" Blade 2.8 cm  
27-332-150 15 cm, 6" Blade 5 cm  
27-333-150 15 cm, 6" Blade 7.5 cm  
27-334-150 15 cm, 6" Blade 10 cm



**KILLIAN NASAL SPECULUM**  
27-335-130 5 cm, 2" Small blade  
27-336-130 7.5 cm, 3" Medium blade  
13 cm, 5 1/4"



## SEPTUM FORCEPS

Nasenpolyenzangen  
Pinzas Para Pólipos Nasaes

Pinces À Polypes Nasaux  
Pinze Per Polipi Nasali



**HARTMANN**  
27-337-160  
16 cm, 6 1/4"  
27-338-200  
20 cm, 8"



**HEYMANN-KNIGHT**  
27-339-180  
18 cm, 7"



**LUBET-BARBON**  
27-340-200  
20 cm, 8"



**KILLIAN**  
27-341-170  
17 cm, 6 3/4"

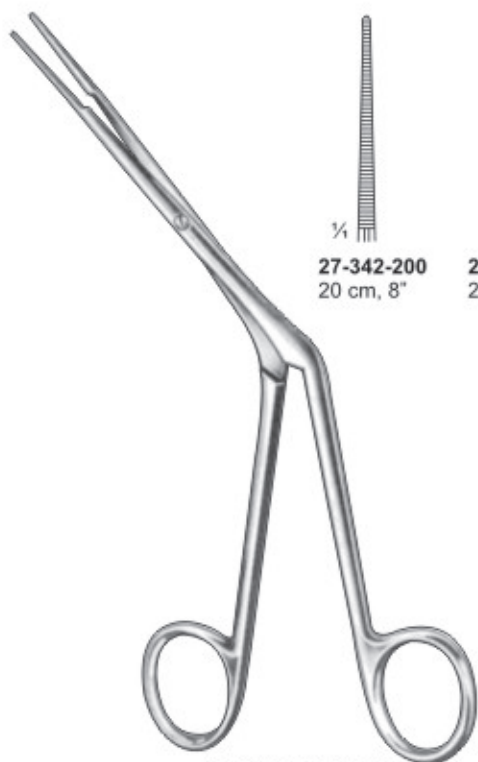

**WESTMACOTT**

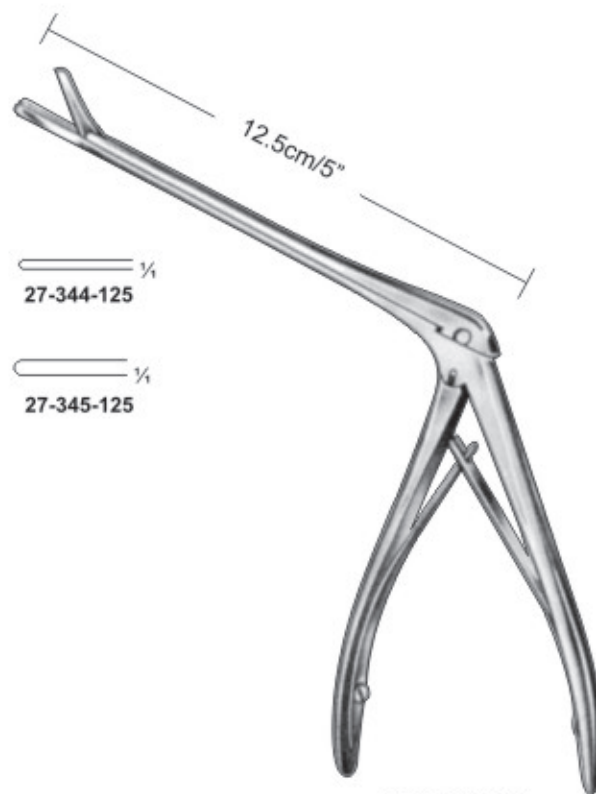
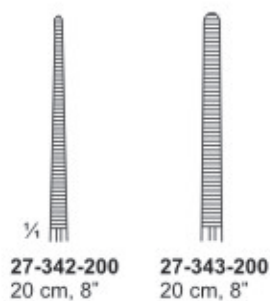

**STRUYCKEN**

# SEPTUM FORCEPS

Nasenpolyenzangen  
Pinzas Para Pólipos Nasaes

Pinces À Polypos Nasaux  
Pinze Per Polipi Nasali



**GRAIG**  
27-346-170  
18 cm, 7"

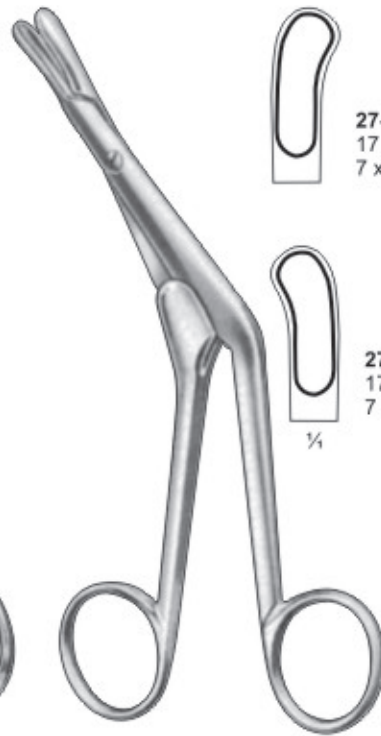

**GRAIG-DOMNICK**  
18 cm, 7"

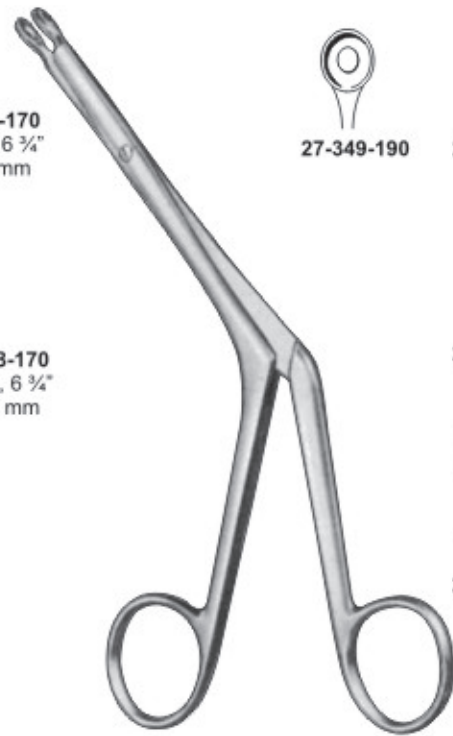

**BRUENINGS**  
19 cm, 7 1/2"

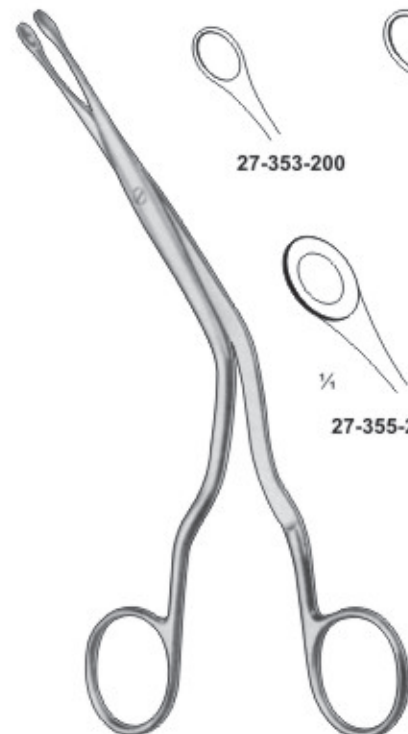

**LUC**  
20 cm, 8"

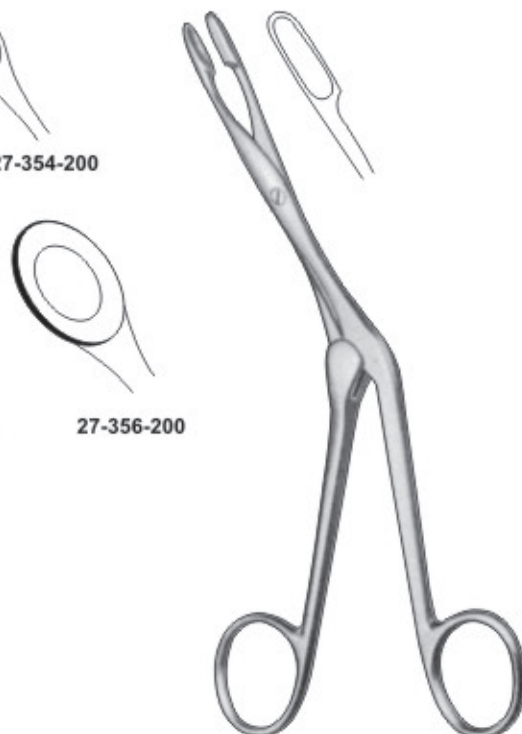

**KNIGHT**  
27-357-180  
18 cm, 7"

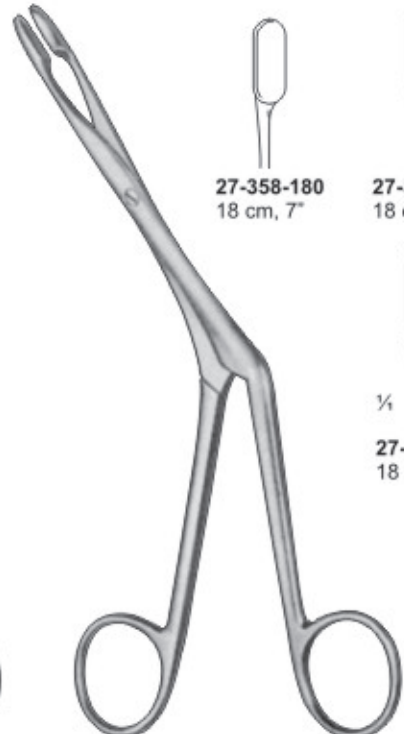

**HEYMANN**



5 x 18 mm



27-347-170  
17 cm, 6 3/4"  
7 x 18 mm



27-348-170  
17 cm, 6 3/4"  
7 x 18 mm

1/4



27-349-190



27-350-190



27-351-190



27-352-190



27-353-200



27-354-200



27-355-200



27-356-200



27-358-180  
18 cm, 7"



27-359-180  
18 cm, 7"



27-360-180  
18 cm, 7"





## NASAL SCISSORS, NASAL TOMPON

Nasenscheren, Nasentamponinzetten  
Tijeras nasales, Septumzangen

Ciseaux nasaux, Pincesa à Pansements  
Forbici nasali, Pincas Pour La Cloison Nasale

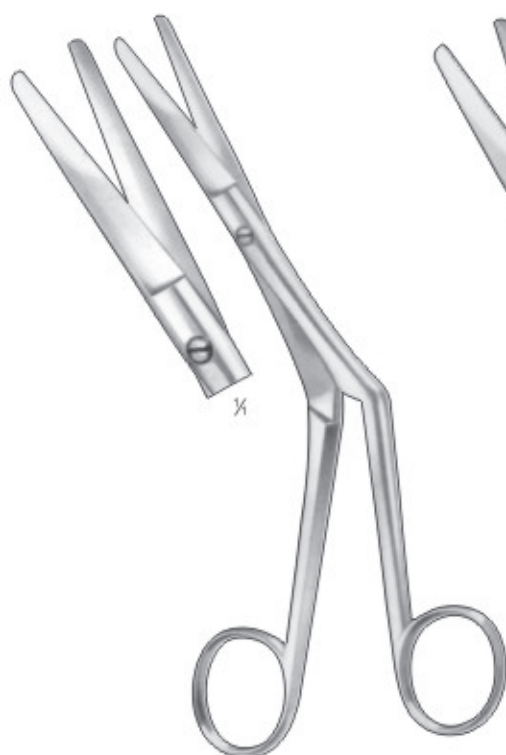

**HEYMANN**  
27-361-200  
Nasal Scissors  
20 cm, 8"



**KIRSTEIN**  
27-362-180  
Nasal Scissors,  
blades serrated  
18 cm, 7"

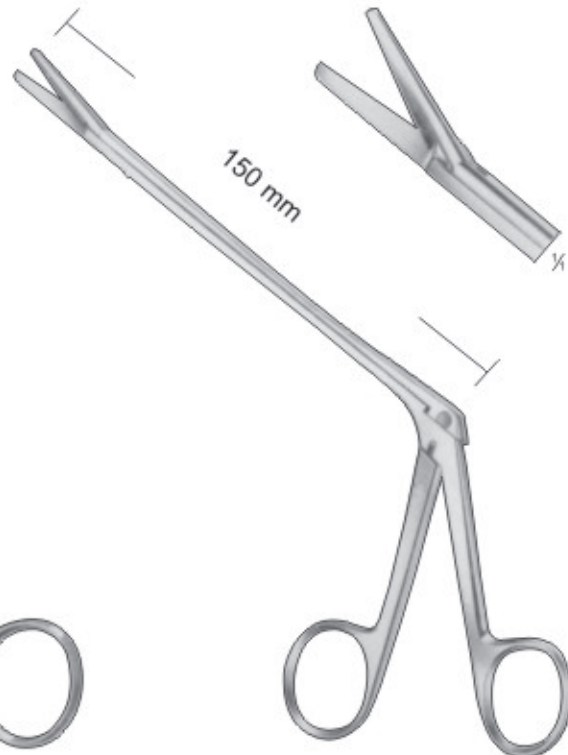

**OLIVECRONE**  
27-363-225  
Nasal Scissors,  
22.5 cm, 9"



**27-364-001**  
Ø 0,3 mm  
Snare Wire  
in coils of 10 meters



**KRAUSE**  
27-365-250  
25 cm, 10"  
Nasal Polypus  
Snare knee-shaped  
27-366-001  
Tube only  
27-367-002  
Wire Guide Only



**KRAUSE-VOSS**  
27-368-250  
25 cm, 10"  
Nasal Polypus Snare,  
knee shaped, complete  
27-369-001  
Tube with wire  
guide only, vertical  
27-370-002  
Tube with wire  
guide only, horizontal



**WILDE**  
27-371-250  
Nasal Polypus Snare,  
bayonet-shaped



**27-372-001**  
Ø 0,3 mm  
Wire Loops for nasal snares,  
package of 100 pieces,  
Sales unit: PH=100 pieces

# ALAR HOOKLETS, NASAL RETRACTORS



Nasenflügelhäkchen, Nasenhaken  
Ganchitos Para Alas De Nariz, Separadores Nasales,

Crochets Pour Les Ailes Du Nez, Ecarteurs Nasaux  
Uncini Per Le Pinne Nasali, Divaricatori Nasali

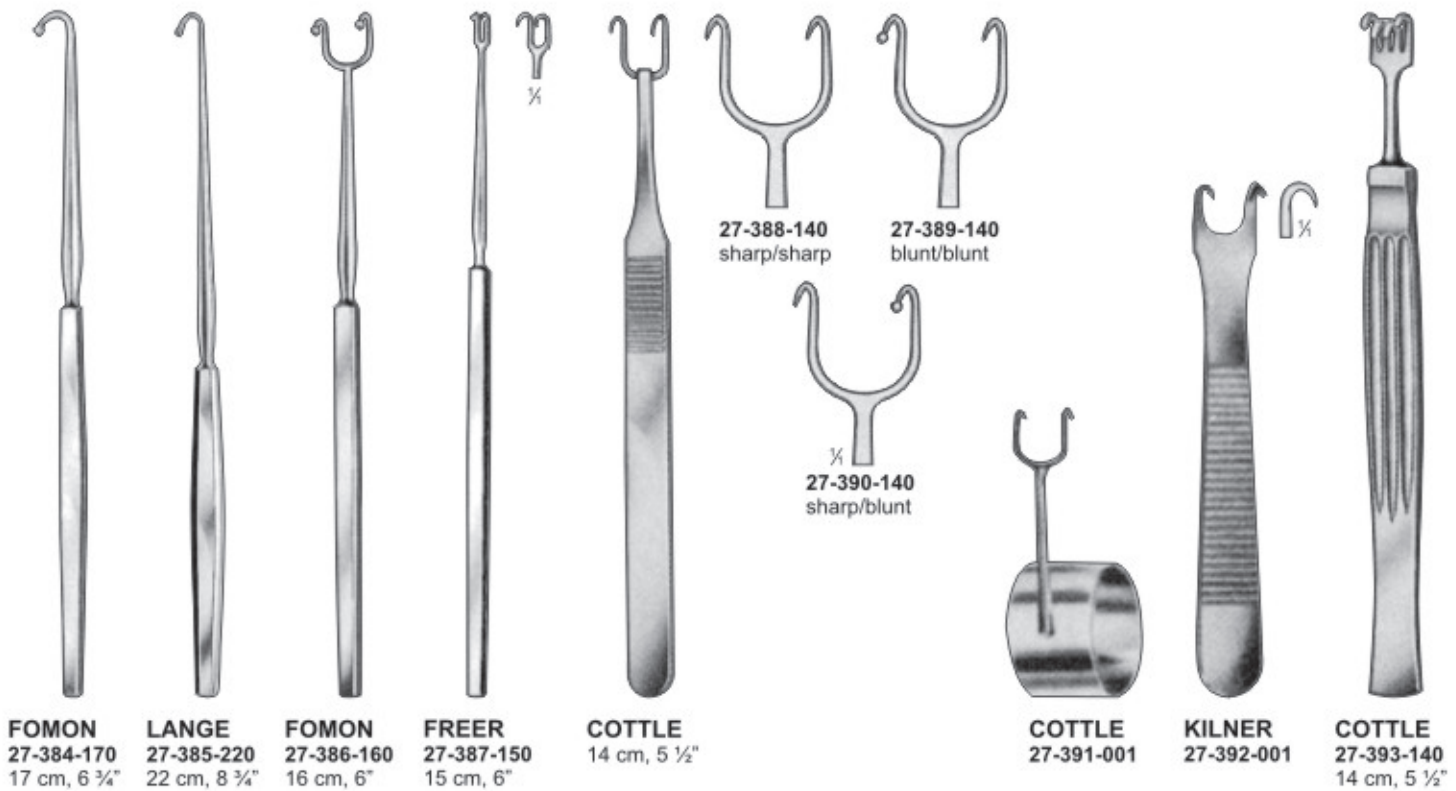



## SEPTUM KNIVES, MALLETS

Septummesser, Hämmer  
Cuchillos Para Tabique Nasal, Martillos

Bistouris Pour La Cloison Nasale, Maillets  
Bisturi Per Il Setto Nasale, Martelli



**BALLENGER**



**27-394-200**  
20 cm, 8"  
Swivel  
4mm



**BALLENGER**

**27-395-200** 4 x 3 mm  
**27-396-200** 5 x 4 mm  
**27-397-200** 6 x 5 mm  
20 cm, 8"  
Swivel Knife,  
bayonet-shaped



3 mm



4 mm



5 mm



**JOSEPH**  
**27-398-170**  
17 cm, 6 3/4"  
straight



**JOSEPH**  
**27-399-170**  
17 cm, 6 3/4"  
bayonet shaped  
right curved



**JOSEPH**  
**27-400-170**  
17 cm, 6 3/4"  
bayonet shaped  
left curved, nasal saws

# SEPTUM CHISELS, SEPTUM GOUGES



*Septummeißel, Septum-Hohlmeißel*

*Cinceles Para Tabique Nasal, Gubias Para Tabique Nasal*

*Ciseaux-burins Pour La Cloison Nasale, Gouges Pour La Cloison Nasale*

*Scalpello Per il Setto Nasale, Sgorbie Per il Setto Nasale*



**FREER**  
27-401-160  
16 cm, 6 1/4"  
4 mm wide  
Septum Chisel,  
straight



**FREER**  
27-402-160  
16 cm, 6 1/4"  
4 mm wide  
Septum Chisel,  
curved



**FREER**  
27-403-150  
15 cm, 6"  
6 mm wide  
Septum Gouge,  
straight

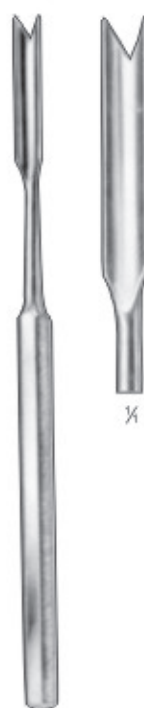

**BALLENGER**  
27-404-155  
15.5 cm, 6"  
6 mm wide  
Septum Gouge



**KILLIAN-CLAUS**  
27-405-170  
17 cm, 6 3/4"  
5 mm wide  
Septum Gouge



**KILLIAN**  
27-406-170  
17 cm, 6 3/4"  
5 mm wide  
Septum Gouge



**MASING**  
27-407-180  
18 cm, 7"



**MASING**  
27-408-180  
18 cm, 7"



**MASING**  
27-409-180  
18 cm, 7"



**MASING**  
27-410-180  
18 cm, 7"



# SEPTUM CHISELS, SEPTUM GOUGES

Septummeißel, Septum-Hohlmeißel  
Cinceles Para Tabique Nasal, Gubias Para Tabiwue Nasal

Ciseaux-burins Pour La Cloison Nasale, Gouges Pour La Cloison Nasale  
Scalpello Per il Setto Nasale, Sgorbie Per il Setto Nasale



**SILVER**  
27-411-180  
18 cm, 7"



**SILVER**  
27-412-180  
18 cm, 7"



**SILVER**  
27-413-180  
18 cm, 7"



**WALTER**  
27-414-180  
chisel with notch,  
double guarded  
18 cm, 7"



**NEIVERT**  
27-415-200  
20 cm, 8"



**ANDERSON-NEIVERT**  
27-416-200  
20 cm, 8"



**ANDERSON-NEIVERT**  
27-417-200  
20 cm, 8"



**CONVERSE**



**CONVERSE**  
27-418-190  
19 cm, 7 1/2"

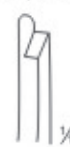

**CONVERSE**  
27-419-190  
19 cm, 7 1/2"



**GILLIES**  
Osteotome  
14 cm, 5 1/2"



27-420-140 5 mm  
27-421-140 7 mm  
27-422-140 9 mm

# OSTEOTOMES



Osteotome  
Osteótomos

Osteotomes  
Ostéotomi



**COTTLE.**  
27-423-180  
fishtail osteotomes  
with protected ends  
double guarded  
18 cm, 7"

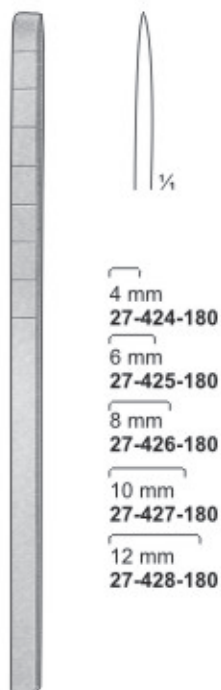

**COTTLE**  
osteotmes with depth  
markings 4 mm, 6 mm,  
8 mm, 10 mm, 12 mm,  
18 cm, 7"

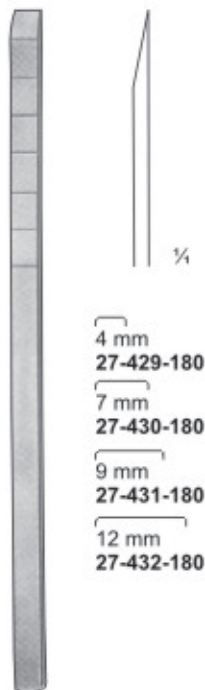

**COTTLE**  
chisel with depth  
markings  
18 cm, 7"



**COTTLE**  
27-433-180  
osteotome, curved,  
depth markings  
18 cm, 7"

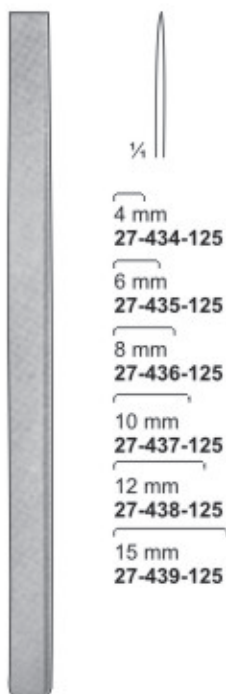

**LAMBOTTE**  
4 mm, 6 mm, 8 mm,  
10 mm, 12 mm, 15 mm  
Osteotome  
12.5 cm, 5"

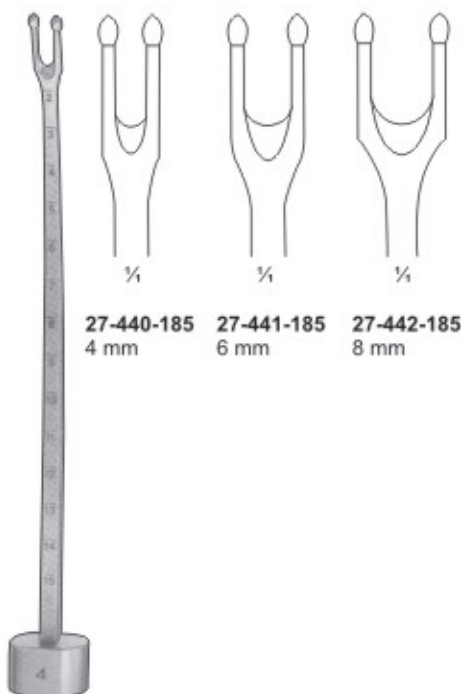

**OSTEOTOMES  
for septum**  
18.5 cm, 7 1/4 "

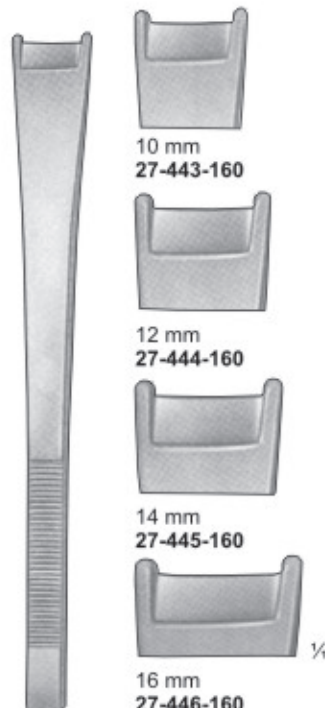

**CINELLI**  
osteotome, double  
guarded, straight  
16 cm, 6 1/4"



**FOMON**  
27-447-170 5 mm  
27-448-170 8 mm  
17 cm, 6 3/4"



# SEPTUM ELEVATORS, PERIOSTEAL ELEVATORS

Septum elevatorien, Periostelevatorien

Élévateurs Pour La Cloison Nasale, Elévateurs Pour Le Périoste

Elceadores Para Tabique Nasal, Laegras Para Periostio

Elevatori Per Il Setto Nasale, Elevatori Per il Periosto



**FREER**  
27-449-155  
15.5 cm, 6 1/4"  
Mucous Knife



**BRUNINGS**  
27-450-155  
15.5 cm, 6 1/4"  
Septatome



**HALLE**  
27-451-180 18 cm, 7"  
3,3 mm  
Elevator blunt

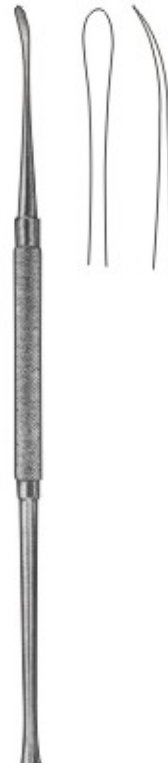

**FREER**  
27-452-190 19 cm, 7 1/2"  
4 mm  
Respiratory sharp

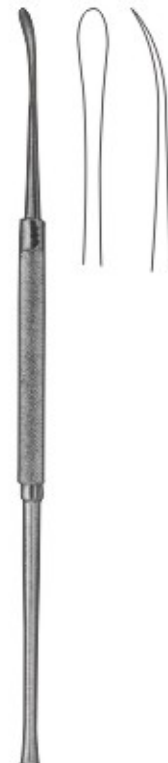

**FREER**  
27-453-190 19 cm, 7 1/2"  
4 mm  
Respiratory sharp



**FREER**  
27-454-190 19 cm, 7 1/2"  
4 mm  
Elevator curved



**FREER**  
27-455-175  
4 mm  
Raspatory Sharp  
17.5 cm, 7"

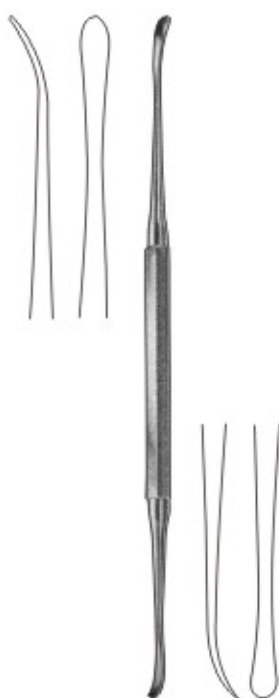

**FREER**  
27-456-180  
18 cm, 7"  
Elevator, sharp / blunt



**FREER-YASARGIL**  
27-457-180  
18 cm, 7"  
Dissector, sharp

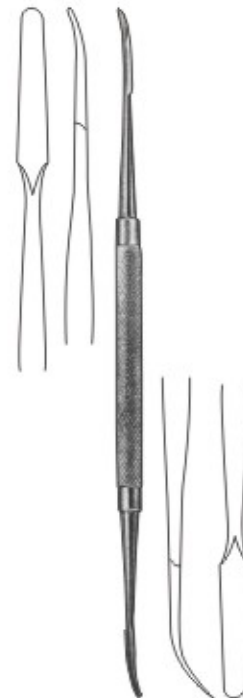

**KILLIAN**  
27-458-180  
18 cm, 7"  
Elevator, sharp / blunt

# SEPTUM ELEVATORS, PERIOSTEAL ELEVATORS



Septumelevatorien, Periostelevatorien  
 Elceadores Para Tabique Nasal, Lae gras Para Periostio

Élévateurs Pour La Cloison Nasale, Élévateurs Pour Le Périoste  
 Elevatori Per Il Setto Nasale, Elevatori Per il Periostio



**HILL**  
 27-459-220  
 22 cm, 8 3/4"  
 Elevator, semi-sharp / blunt

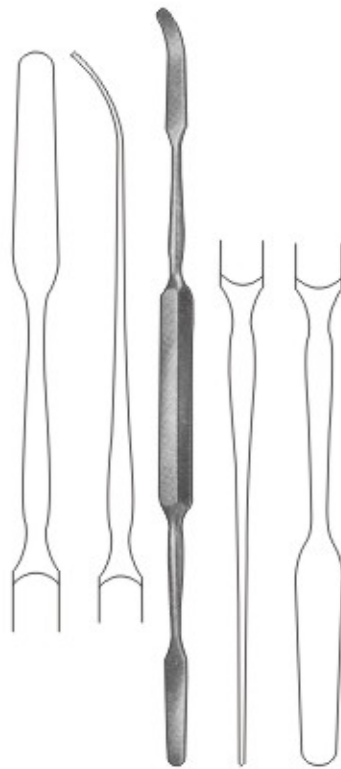

**MACDONALD**  
 27-460-190  
 19 cm, 7 1/2"  
 Dissector, blunt / blunt



**WATRON-CHEYNE  
 RASPATORY**  
 19 cm, 7 1/2"

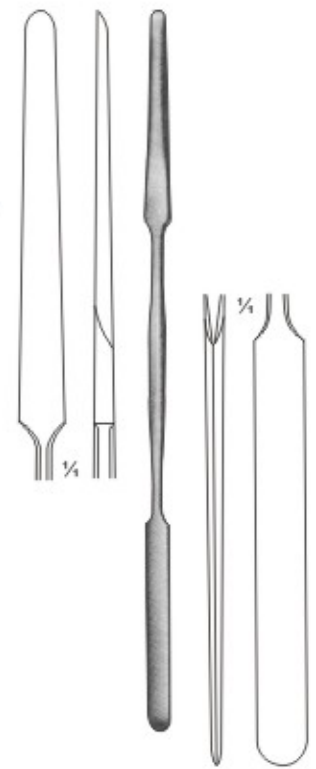
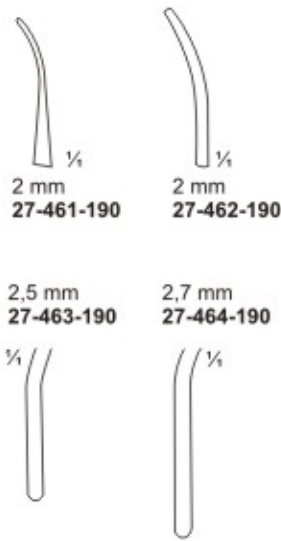

**KILLIAN**  
 27-465-185  
 18.5 cm, 7 1/4"  
 Elevator sharp / blunt



**Negus**  
 27-466-210  
 6 mm  
 suction dissector  
 21 cm, 8 1/4"  
 Olive  
 Ø 6 mm



**Negus**  
 27-467-215  
 21.5 cm, 8 1/4"  
 6 mm  
 suction dissector,  
 insulated  
 Olive  
 Ø 6 mm  
 0.4 mm

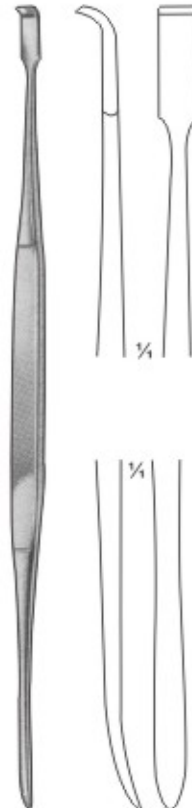

**HOWASTH**  
 27-468-215  
 21.5 cm, 8 1/4"  
 Elevator

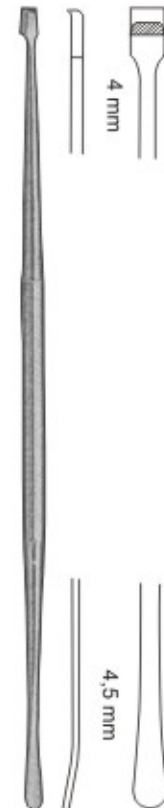

**FREER**  
 27-469-180  
 separator &  
 elevator  
 180 cm, 7"





# SEPTUM, PERIOSTEAL ELEVATORS

Septum elevatorien, Periostelevatorien

Élévateurs Pour La Cloison Nasale, Elévateurs Pour Le Périoste

Elceadores Para Tabique Nasal, Laegras Para Periostio Elevatori Per Il Setto Nasale, Elevatori Per il Periosto



**ST CLAIR THOMPSON**  
27-470-160  
sharp / blunt  
Raspatory, periosteal elevator  
16 cm, 6 1/4"



**FREER**  
27-471-160  
sharp / blunt  
Septum chisel,  
straight  
16 cm, 6 1/4"



**FREER**  
27-472-160  
sharp / blunt  
Septum chisel,  
Curved  
16 cm, 6 1/4"



**PENNINGTON**  
Raspatory  
27-473-210  
21 cm, 8 1/4"



**COTTLE**  
27-474-200  
Elevator, double-  
ended, graduated  
20 cm, 8"



**COTTLE**  
27-475-200  
Elevator, double-  
ended, graduated  
20 cm, 8"

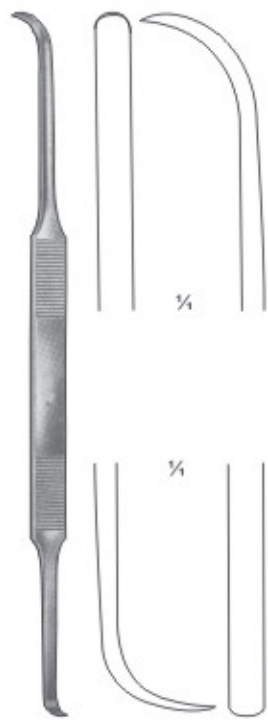

**COTTLE**  
27-476-200  
Elevator, double-  
ended, for tunneling  
20 cm, 8"

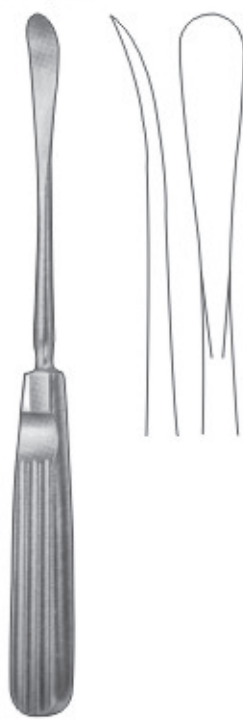

**COTTLE**  
27-477-200  
Periosteal Elevator,  
curved, sharp  
20 cm, 8"



**HALLE**  
27-478-180  
Elevator, blunt  
18 cm, 7"

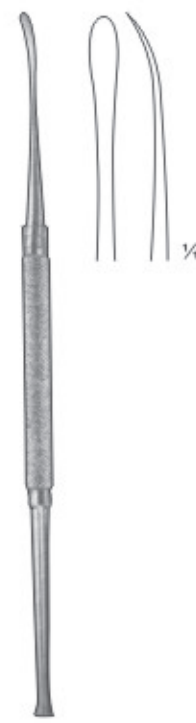

**FREER**  
27-479-180  
Raspatory, sharp  
18 cm, 7"

# SEPTUM, PERIOSTEAL ELEVATORS



Septumelevatorien, Periostelevatorien

Élévateurs Pour La Cloison Nasale, Élévateurs Pour Le Périoste

Elceadores Para Tabique Nasal, Lae gras Para Periostio Elevatori Per Il Setto Nasale, Elevatori Per il Periostio

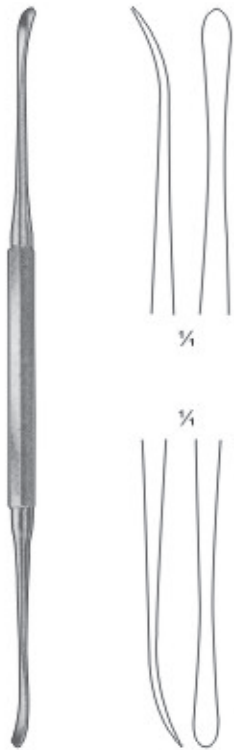

**FREER**  
27-480-180  
Elevator sharp blunt  
18 cm, 7"

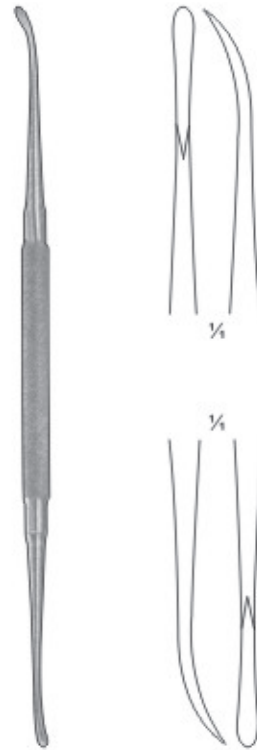

**FREER YASARGIL**  
27-481-180  
Dissector sharp  
18 cm, 7"

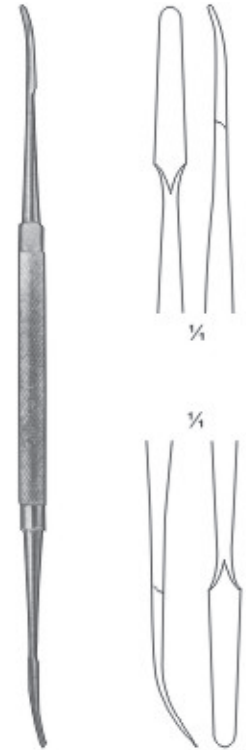

**FREER YASARGIL**  
27-482-180  
Dissector sharp/blunt  
18 cm, 7"

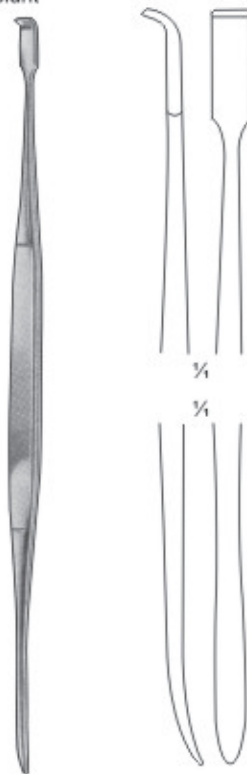

**HOWARTH**  
27-483-215  
Elevator  
21.5 cm 8 1/2"

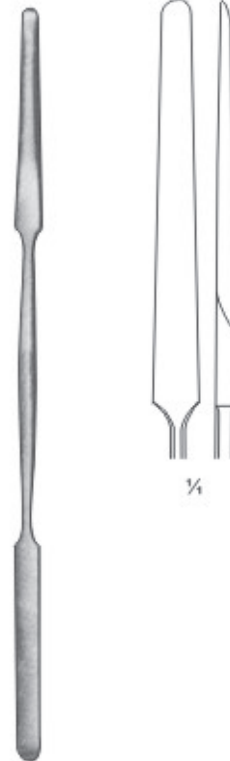

**KILLIAN**  
27-484-215  
Elevator sharp/blunt  
21.5 cm 8 1/2"



## RHINOPLASTIC KNIVES, SEPTUM KNIVES

Rhinoplastik-Messer, Septummesser, Schwingmesser  
Cuchillos Para Rinoplástica, Cuchillos Para Tabique Nasal

Couteaux Pour Plastic Du Nez, Bistouris Pour La Cloison Nasale  
Bisturi Per Plastica Nasale, Bisturi Per Il Setto Nasale



**FREER**  
Elevator, blunt  
27-485-190  
19cm, 7 1/2"



**FREER**  
27-486-185  
Knife curved  
18.5 cm, 7 1/4"



**FREER**  
27-487-185  
Elevator sharp  
18.5 cm, 7 1/4"



**SAALFELD**  
27-488-180  
18 cm, 7"  
Milium Knife and  
Comedone Extractor



**HERBA**  
27-489-180  
18 cm, 7"  
Milium Knife and  
Comedone Extractor

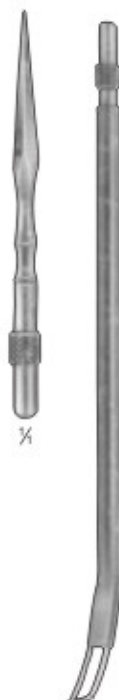

**HERBA**  
27-490-115  
11.5 cm, 4 1/2"  
Milium Knife and  
Comedone Extractor



**UNNA**  
27-491-140  
14 cm, 5 1/2"  
Comedone Extractor,  
double-ended

# SEPTUM FORCEPS



Septumzangen  
Pinzas Para Tabique Nasal

Pinces Pour La Cloison Nasale  
Pinze Per il Setto Nasale



**27-492-190**  
19 cm, 7 1/2"  
Double Action  
5 x 15mm tip

**JANSEN-MIDDLETON**



**27-493-190**  
19 cm, 7 1/2"  
Double Action  
4 x 20 mm tip

**JANSEN-MIDDLETON**

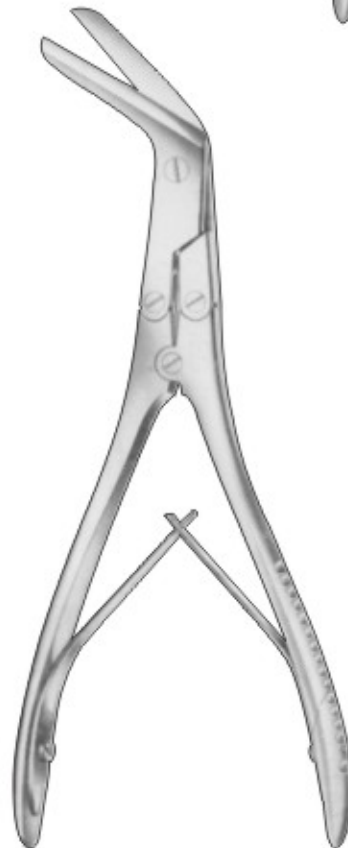

**KILLIAN**  
**27-494-200**  
20 cm, 8"



# GLABELLA RASPS, NASAL RASPS

Glbellaraspeln Nasenraspeln

Escofinas Para Glabella, Escofinas Nasaes, Escofinas Nasaes

Râpes Pour La Glabella, Râpes Nasaes, Râpes Nasaes

Raspe Per Glabella, Raspe Nasali, Raspe Nasali

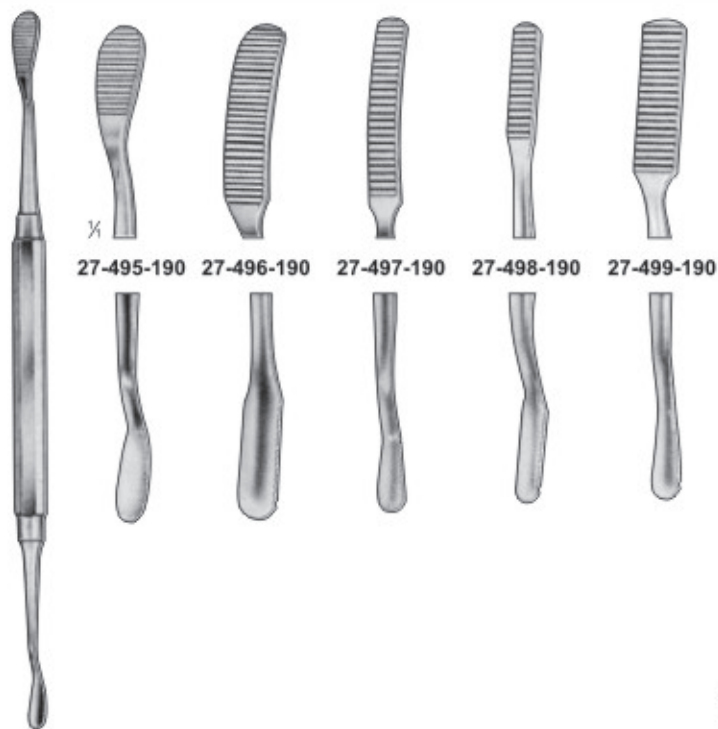

1/4

27-495-190

27-496-190

27-497-190

27-498-190

27-499-190

## MILLER-COLBURN

19 cm, 7 1/2"



8 mm

27-500-185

8 mm

27-501-185

## MILLER

Rasps, set to cut on down stroke, fine teeth

8 mm

Rasps, set to cut on down stroke, coarse teeth

18.5 cm, 7 1/4"



9 mm

27-502-185

9 mm

27-503-185

## AUFRICHT 9 mm

Rasps, set to cut on up stroke

9 mm

Rasps, set to cut on down stroke

18.5 cm, 7 1/4"



1/4

27-504-180

Large Serrations

## LEWIS

18 cm, 7"

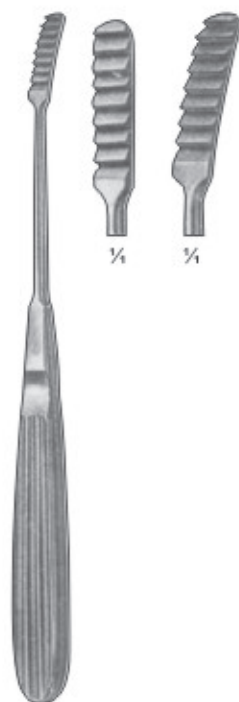

1/4

1/4

## MALTZ

27-505-180

straight

Rasp

18 cm, 7"



9 mm

1/4

## MALTZ

27-506-180

Rasp, teeth set to cut on down stroke

18 cm, 7"

# GLABELLA RASPS, NASAL RASPS



*Glbellaraspeln Nasenraspeln Escofinas Para Glabella, Râpes Pour La Glabelle, Râpes Nasales, Râpes Nasales*  
*Escofinas Nasales, Escofinas Nasales* *Raspe Per Glabella, Raspe Nasali, Raspe Nasali*

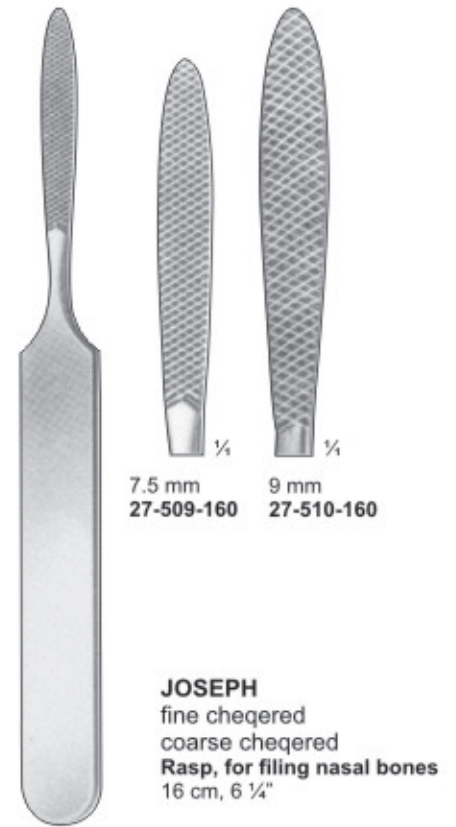
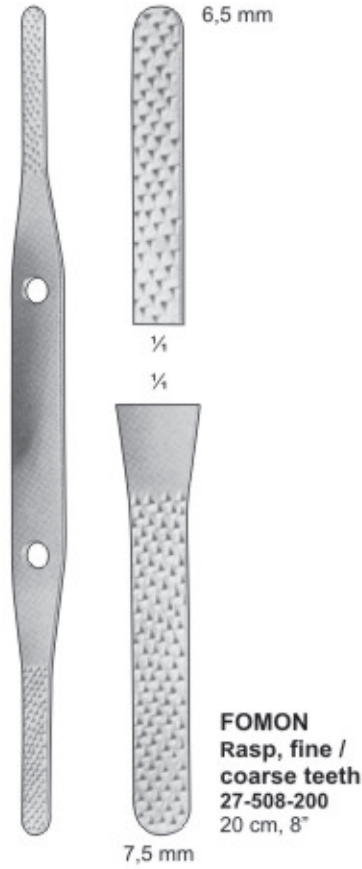
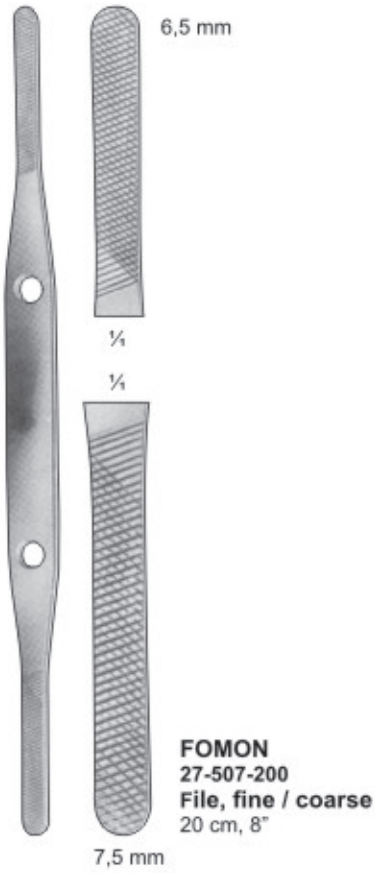



# SPHENOID BONE PUNCHES

Pinzas Sacabocadas Para Esfenoides,  
Pinzas Sacabocadas Para Seno Maxilar

Pinze Taglienti Per Seno Sfenoidale,  
Pinze Taglienti Per Seno Mascellare

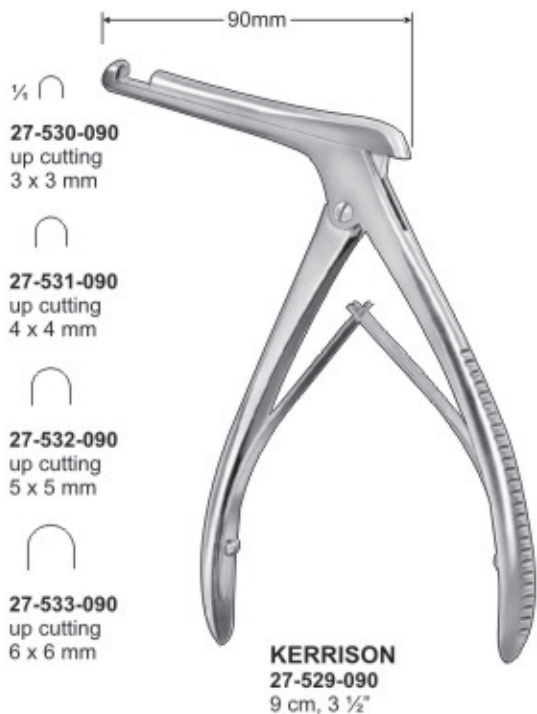
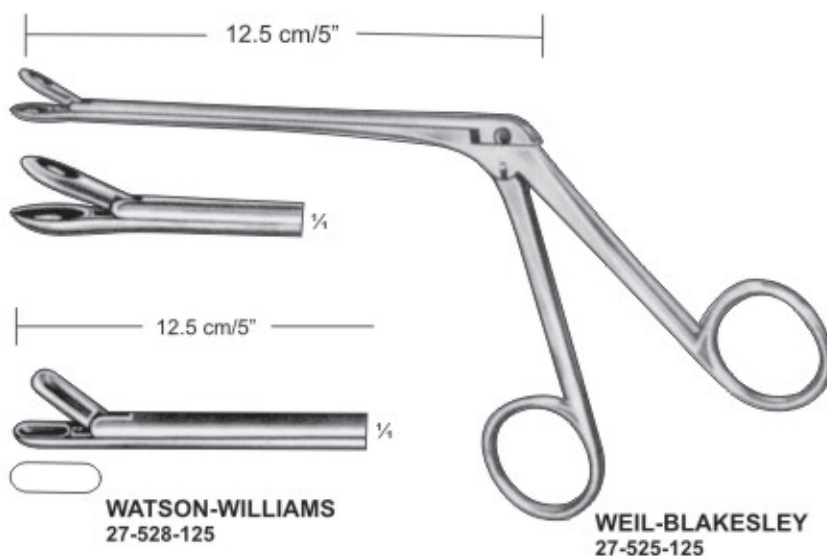
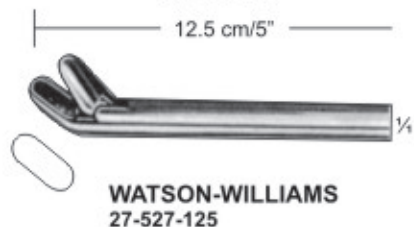
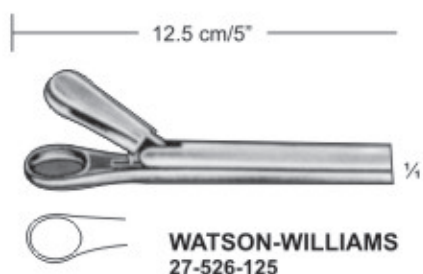
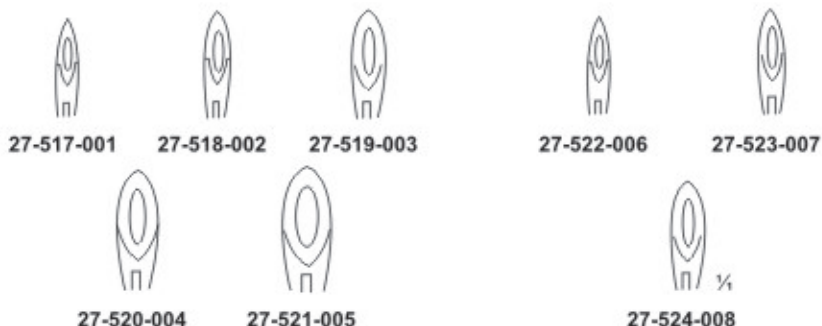
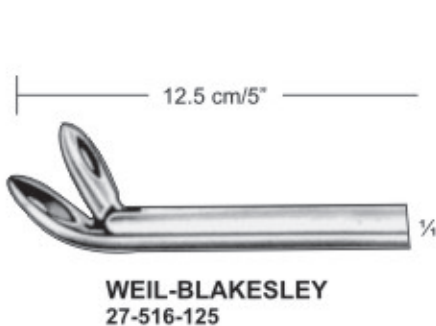

# TONSIL PUNCHES



Tonsillenzangen  
Pinzas Para Amígdalas

Pinces Pour Amygdalas  
Pinze Per Tonsille

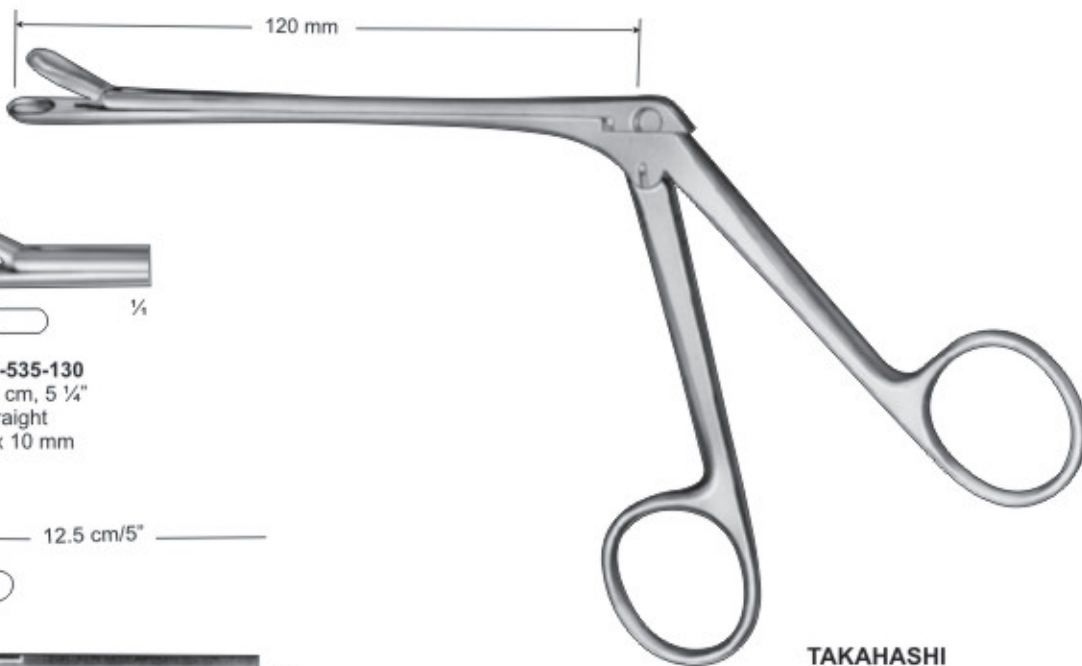

**TAKAHASHI**  
19 cm, 7 1/2"



**27-535-130**  
13 cm, 5 1/4"  
Straight  
5 x 10 mm

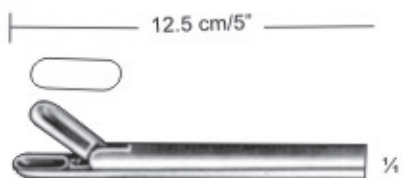

**WATSON-WILLIAMS**  
27-536-125

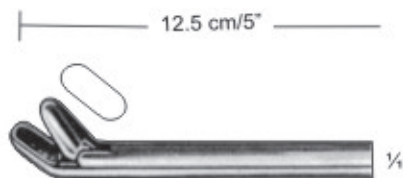

**WATSON-WILLIAMS**  
27-537-125

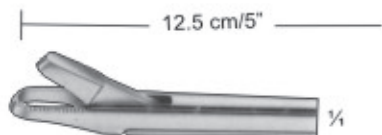

**27-538-125**



**27-539-125**

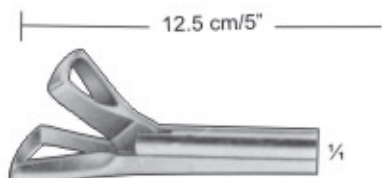

**27-540-125**



**27-541-125**

**SCHMEDEN**  
Nasal Cutting Forceps

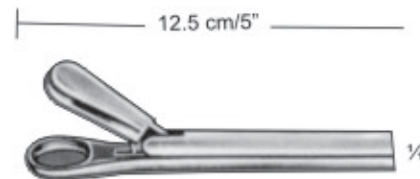

**WATSON-WILLIAMS**  
27-542-125

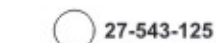

**27-543-125**

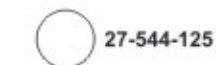

**27-544-125**

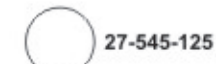

**27-545-125**

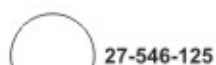

**27-546-125**

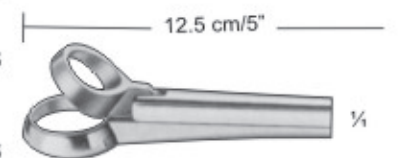

**HARTMANN**  
Nasal Cutting Forceps

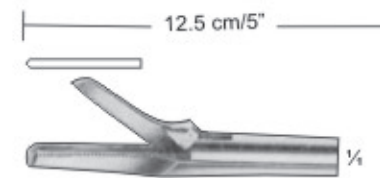

**STRUYCKEN**  
Nasal Cutting Forceps  
27-547-125





## CARTILAGE CRUSHER, SEPTUM FORCEPS

Knorpelquetsche, Septumzangen  
Machacadora, Septumrichtzangen

Pinces-gouge à Cartilage, Pinces Pour La Cloison Nasale,  
Torchio Per Cartilagine, Pinze Per il Setto Nasale



**ASCH**  
27-548-230  
23 cm, 9"



**WALSHAM**  
21 cm, 8 1/4"

1/4  
27-549-210  
right

27-550-210  
left



**BOIES**  
27-551-180  
18 cm, 7"



Cottle Bone



27-552-001  
Cottle Cartilage Crusher

# SUCTION TUBE



Sauger, Saugrohre  
Tubos de aspiración

Tubos d aspiracion  
Tubi d aspirazion



### FERGUSSON

27-553-180 Ø 2.0 mm, 6 F.G.  
27-554-180 Ø 2.5 mm, 7-8 F.G.  
27-555-180 Ø 3.0 mm, 9 F.G.  
27-556-180 Ø 4.0 mm, 12 F.G.  
27-557-180 Ø 5.0 mm, 15 F.G.  
18 cm, 7"



### PLESTER

27-558-195 Ø 1.5 mm, 4-5 F.G.  
27-559-195 Ø 2.0 mm, 6 F.G.  
27-560-195 Ø 2.5 mm, 7-8 F.G.  
27-561-195 Ø 3.0 mm, 9 F.G.  
19.5 cm, 8"



### NASAL SUCTION TUBES

27-562-160 Ø 5 mm  
16 cm, 6 1/4"



### FRAZIER

27-563-180 Ø 3 mm  
27-564-180 Ø 5 mm  
18 cm, 7"



### FRAZIER



27-565-175  
Outside 4,5 diam.  
17.5 cm, 7"



27-566-175  
Outside 5,5 diam.  
17.5 cm, 7"



## DERMAL PUNCH

Hauttrephine  
Trépano para piel

Trépan cutané  
Trefina cutanea



2mm Ø  
27-567-001

3mm Ø  
27-568-002

4mm Ø  
27-569-003

5mm Ø  
27-570-004

6mm Ø  
27-571-005

7mm Ø  
27-572-006

**KEYES**  
27-567-001 — 27-572-006  
Dermal Punches

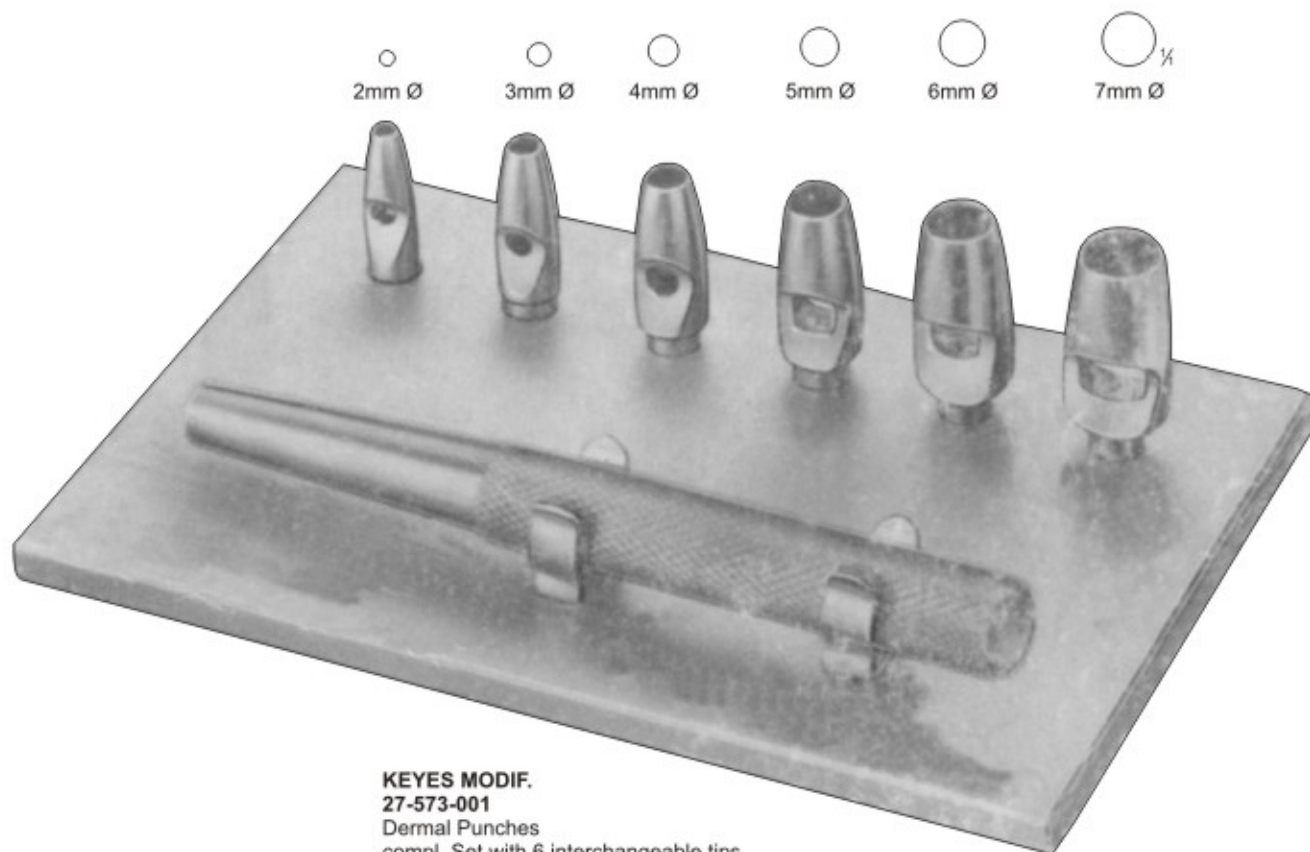

2mm Ø

3mm Ø

4mm Ø

5mm Ø

6mm Ø

7mm Ø

**KEYES MODIF.**  
27-573-001  
Dermal Punches  
compl. Set with 6 interchangeable tips

# SCISSORS

Ciseaux  
Forbici



scheren  
Tijeras

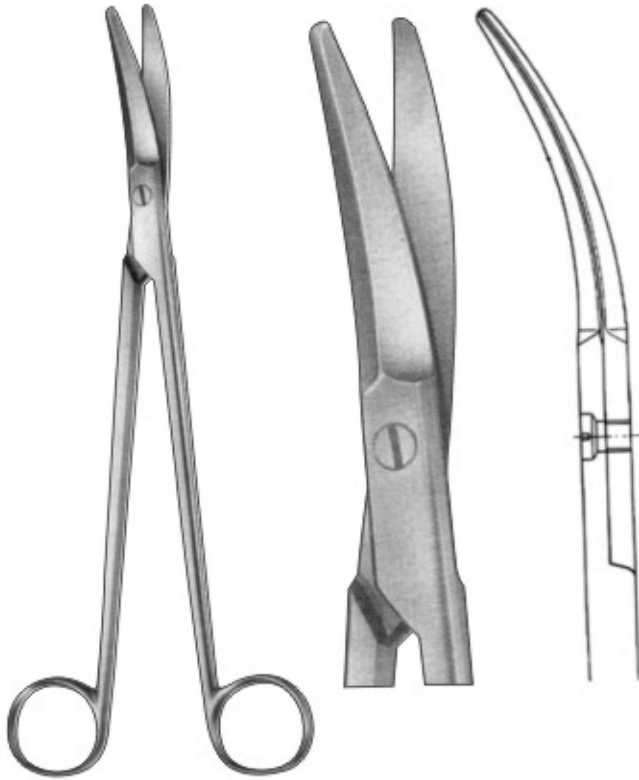

**BOETTCHER**  
Tonsil scissors  
27-574-180 18 cm, 7"



**DEAN**  
Tonsil scissors, with angled,  
serrated blades  
27-575-170 17 cm, 6 3/4"

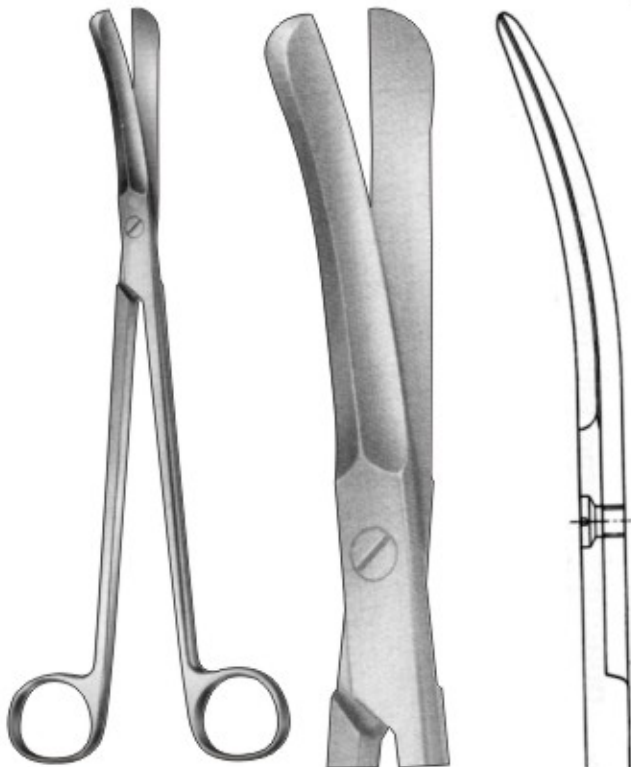

**GOOD**  
Tonsil scissors  
27-576-195 19.5 cm, 7 3/4"

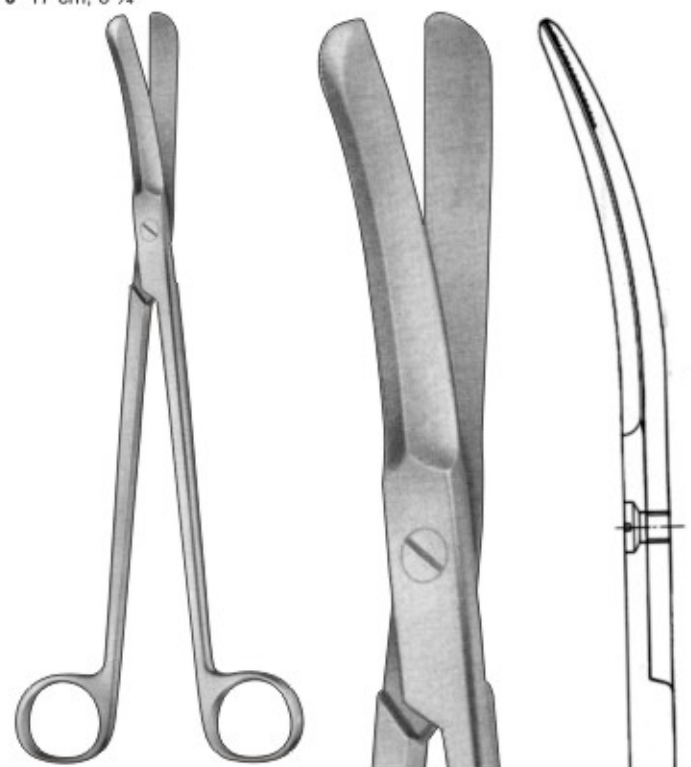

**SCHWECKENDIEK**  
Tonsil scissors  
27-577-195 19.5 cm, 7 3/4"



## CHEEK RETRACTORS, TONGUE DEPRESSORS

Mundsperrer, Lippen- u Wangenhalter  
Abrebocas, Separadores Para Labios y Mejillas

Ouvre-bouche, Ecarteurs Des Lèvres et Joues  
Apribocca, Separatori Per Labbra e Guancia



**TOBOLD**  
27-578-145  
14.5 cm, 5 3/4"

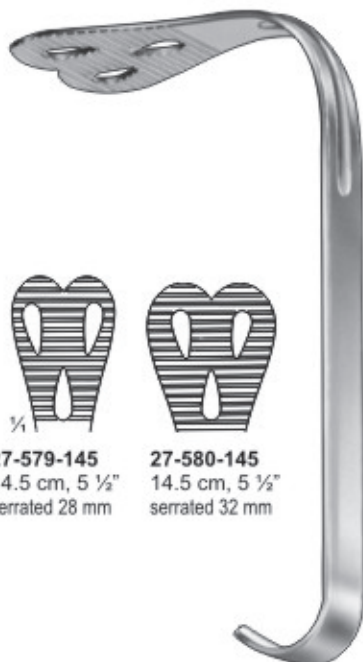

**WEIDER**

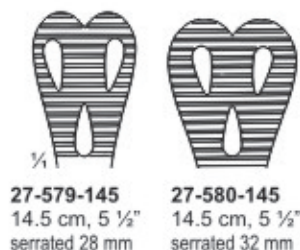

27-579-145  
14.5 cm, 5 1/2"  
serrated 28 mm

27-580-145  
14.5 cm, 5 1/2"  
serrated 32 mm



**TONGUE DEPRESSOR**  
27-581-145  
14.5 cm, 5 3/4"



**TONGUE DEPRESSOR**  
27-582-145  
14.5 cm, 5 3/4"



**BUCHWALD**  
27-583-180  
Tongue Depressor  
18 cm, 7"



**BRUENINGS**  
27-584-190  
Tongue Depressor  
19 cm, 7 1/2"



**FRENZEL**  
27-585-165  
Tongue Depressor  
16.5 cm, 6 1/2"



**M-SCHMIDT**  
27-586-190  
Tongue Depressor  
19 cm, 7 1/2"  
hollow

# MOUTH GAG, LIP & CHEEK RETRACTORS

Mundsperrer, Lippen- u. Wangenhalter  
Abrebocas, Separadores Para Labios y Mejillas

Ouvre-bouche, Ecarteurs Des Lèvres et Joues  
Apribocca, Separatori Per Labbra e Guancia



**FERGUSON-ACKLAND**  
27-587-145  
14.5 cm, 5 3/4"



**DENHARDT**  
27-588-125  
12.5 cm, 5"  
Mouth Gag  
with silicon inserts,  
interchangeable



**ROSER-KONIG**  
27-589-160  
16 cm, 6 1/4"  
Mouth Gag



**DOYEN-COLLIN**  
27-590-120 12 cm, 5"  
27-591-140 14 cm, 5 1/2"  
Mout Gag



**MOLT**  
27-592-110  
11 cm, 4 1/2"



## MOUTH GAG, LIP & CHEEK RETRACTORS

Mundsperrer, Lippen- u. Wangenhalter  
Abrebocas, Separadores Para Labios y Mejillas

Ouvre-bouche, Ecarteurs Des Lèvres et Joues  
Apribocca, Separatori Per Labbra e Guancia



**HEISTER**  
27-593-130 13 cm, 5"  
Mouth Gag



**WHITEHEAD**  
27-594-090 9 cm, 3 1/2"  
27-595-110 11 cm, 4 1/4"  
27-596-130 13 cm, 5"  
27-597-150 15 cm, 6"  
Mouth Gag



**WHITEHEAD**  
27-598-110 11 cm, 4 1/4"  
27-599-130 13 cm, 5"  
27-600-150 15 cm, 6"  
Mouth Gag  
with tongue depressor



**WHITEHEAD-JENNINGS**  
27-601-090 9 cm, 3 1/2"  
27-602-110 11 cm, 4 1/4"  
27-603-130 13 cm, 5"  
27-604-150 15 cm, 6"  
Mouth Gag

# MOUTH GAGE



Mundsperrer  
Abrebocas

Ouvre-bouche  
Apribocca



**DAVIS-BOYLE**  
27-605-001  
Complete Set  
Double Bite-Lift Side  
Gag only left side



27-606-001



27-607-002



27-608-003



27-609-004



27-610-005

**DAVIS-BOYLE**  
27-606-001 20 X 25mm  
27-607-002 22 X 60mm  
27-608-003 25 X 75mm  
27-609-004 25 X 90mm  
27-610-005 27 X 105mm  
Tongue Blades only.



27-611-001  
Gag Only

**MCIVOR**



27-612-001  
Complete Set  
with 3 Blades

**MCIVOR**  
blade



**MODELL WURZBURG**  
27-613-001 66 x 28 mm  
27-614-002 75 x 32 mm  
27-615-003 83 x 34 mm  
27-616-004 93 x 37 mm  
27-617-005 100 x 38 mm





## MOUTH GAGE

Mundsperrer  
Abrebocas

Ouvre-bouche  
Apribocca



### RUSSEL-DAVIS

27-618-001	29 x 67 mm
27-619-002	33 x 75 mm
27-620-003	38 x 85 mm
27-621-004	40 x 92 mm
27-622-005	46 x 100 mm



### RUSSEL-DAVIS

27-623-001	18 x 57 mm
27-624-002	22 x 67 mm
27-625-003	25 x 75 mm

# MOUTH GAGE

Mundsperrer  
Abrebocas

Ouvre-bouche  
Apribocca



27-626-001  
Gag only

**KILNER-DOUGHTY**  
27-627-002  
complete



1/2  
27-628-003



1/2  
27-629-004



27-630-005



1/2  
27-631-006



**NEGUS**  
27-632-001  
Chest support for Mouth Gag



27-635-003  
55 x 25 mm



27-636-004  
60 x 27 mm



27-637-005  
70 x 30 mm

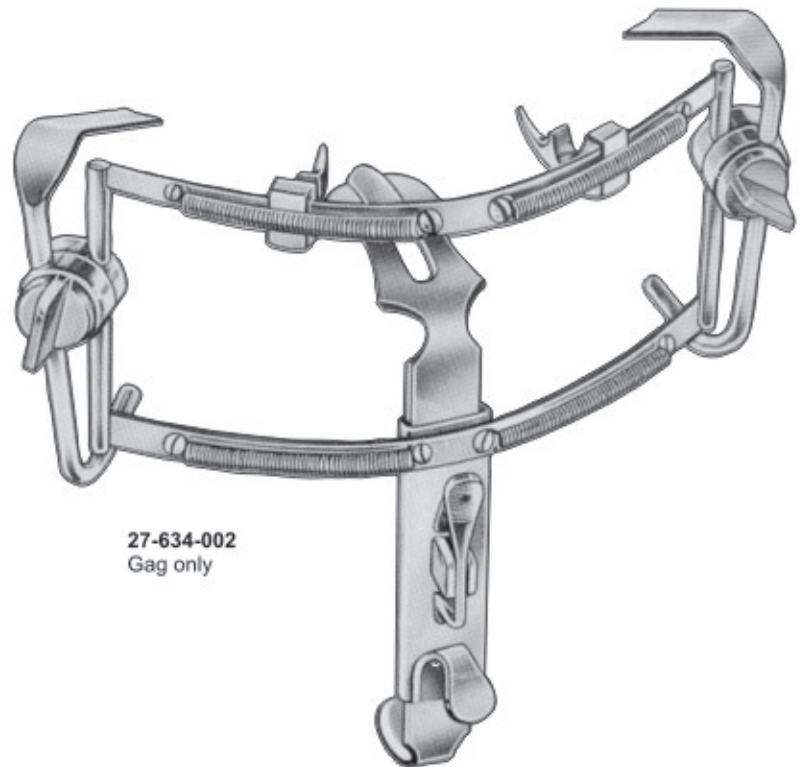

27-634-002  
Gag only

**DINGMANN**  
27-633-001  
complete



# CHEEK RETRACTORS, TONGUE DEPRESSORS

Wangenhalter, Zungendrucker  
Separadores Para Mejillas, Abajalenguas

Ecarteurs Des Joues, Abaisse-langue  
Separatori Per Guancia, Abassalingua

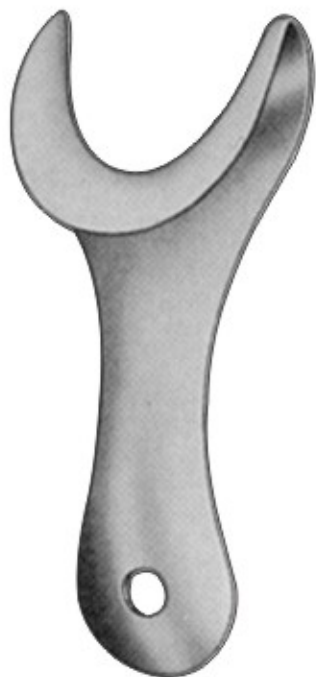

**SIMPLEX**  
27-638-110  
11 cm, 4 1/4"



**STERNBERG**  
27-639-120 12 cm, 5"  
27-640-140 14 cm, 5 1/2"  
27-641-160 16 cm, 6 1/4"



**HARTMANN**  
27-642-150  
15 cm, 6"



**UNIV. MINNESOTA**  
27-643-140  
14 cm, 5 1/2"



27-644-190  
19 cm, 7 1/2"



**ROUX**  
27-645-150  
15 cm, 6"  
Cheek Retractor



1/4  
27-646-200  
15 x 15 mm



27-647-210  
20 x 22 mm



27-648-230  
26 x 30 mm



**MIDDELDORPF**  
27-646-200 20 cm, 8"  
27-647-210 21 cm, 8 1/4"  
27-648-230 23 cm, 9"

# TONSIL GRASPING FORCEPS, TONSIL FORCEPS

Tonsillenfasszangen, Tonsillenklemmen  
Pinzas Para Amigdalas

Pinces Pour Amygdalas  
Pinze Per Tonsille



**MARSHIK-KRONE**  
Tonsil holding forceps  
27-649-200 20 cm, 8"

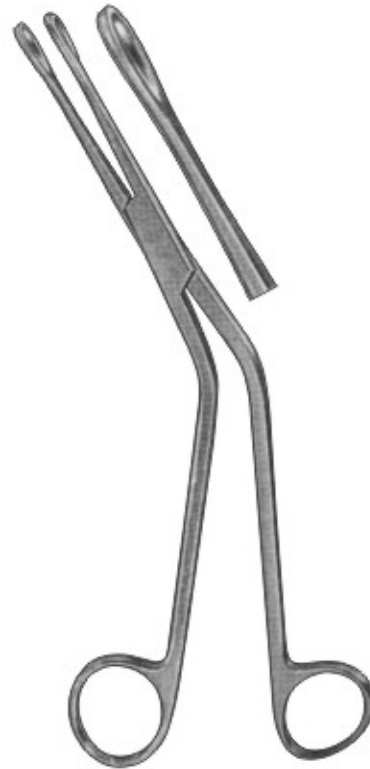

**BLOHMKE**  
Tonsil holding forceps  
27-650-200 20 cm, 8"



**ABRAHAM**  
Tonsil holding forceps  
27-651-200 20 cm, 8"



**BLOHMKE**  
Tonsil holding forceps  
27-652-200 20 cm, 8"



## TONSIL GRASPING FORCEPS, TONSIL FORCEPS

Tonsillenfasszangen, Tonsillenklemmen  
Pinzas Para Amigdalas

Pinces Pour Amygdalas  
Pinze Per Tonsille



**WHITE**  
27-653-180 18 cm, 7"  
27-654-230 23 cm, 9"

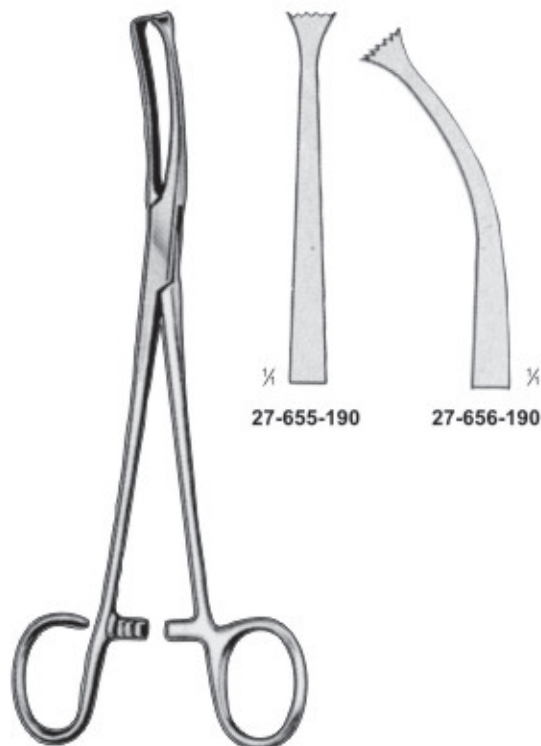

**COLVER**  
19 cm, 7 1/2"

27-655-190

27-656-190



**SCHROEDER**  
27-657-240  
24 cm, 9 1/2"

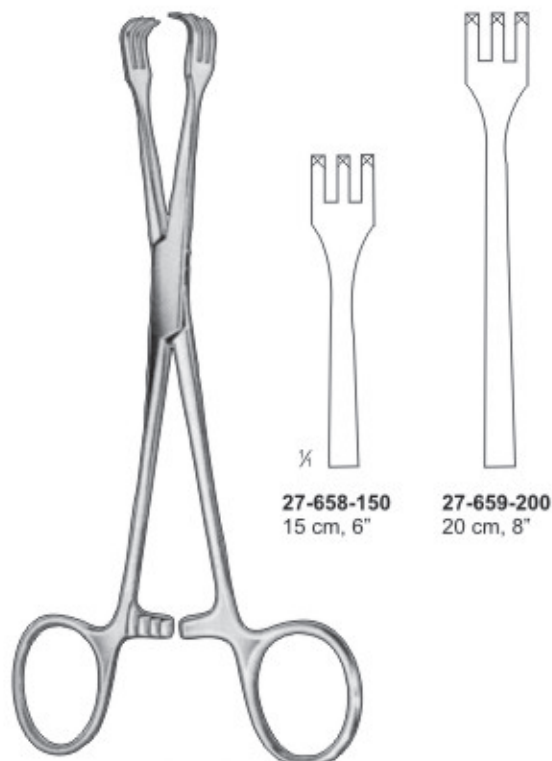

**LAHEY**

27-658-150  
15 cm, 6"

27-659-200  
20 cm, 8"

# TONSIL FORCEPS

Tonsillenklemmen  
Pinzas Para Amigdalas

Pinces Pour Amygdalas  
Pinze Per Tonsille



**STAUDE-MOORE**  
27-660-170  
17 cm, 6 3/4"  
strong pattern



**POZZI**  
27-661-170  
25.5 cm, 10 1/4"



**SCHROEDER**  
27-662-250  
25 cm, 10"



**BRAUN**  
27-663-250  
25 cm, 10"



**DUPLAY**  
27-664-280  
28 cm, 11"



**BEACHAM**  
27-665-260  
26 cm, 10 1/4"



**SKENE**  
27-666-240  
24 cm, 9 1/2"



## TONSIL FORCEPS

Tonsillenklemmen  
Pinzas Para Amigdalas

Pinces Pour Amygdalas  
Pinze Per Tonsille

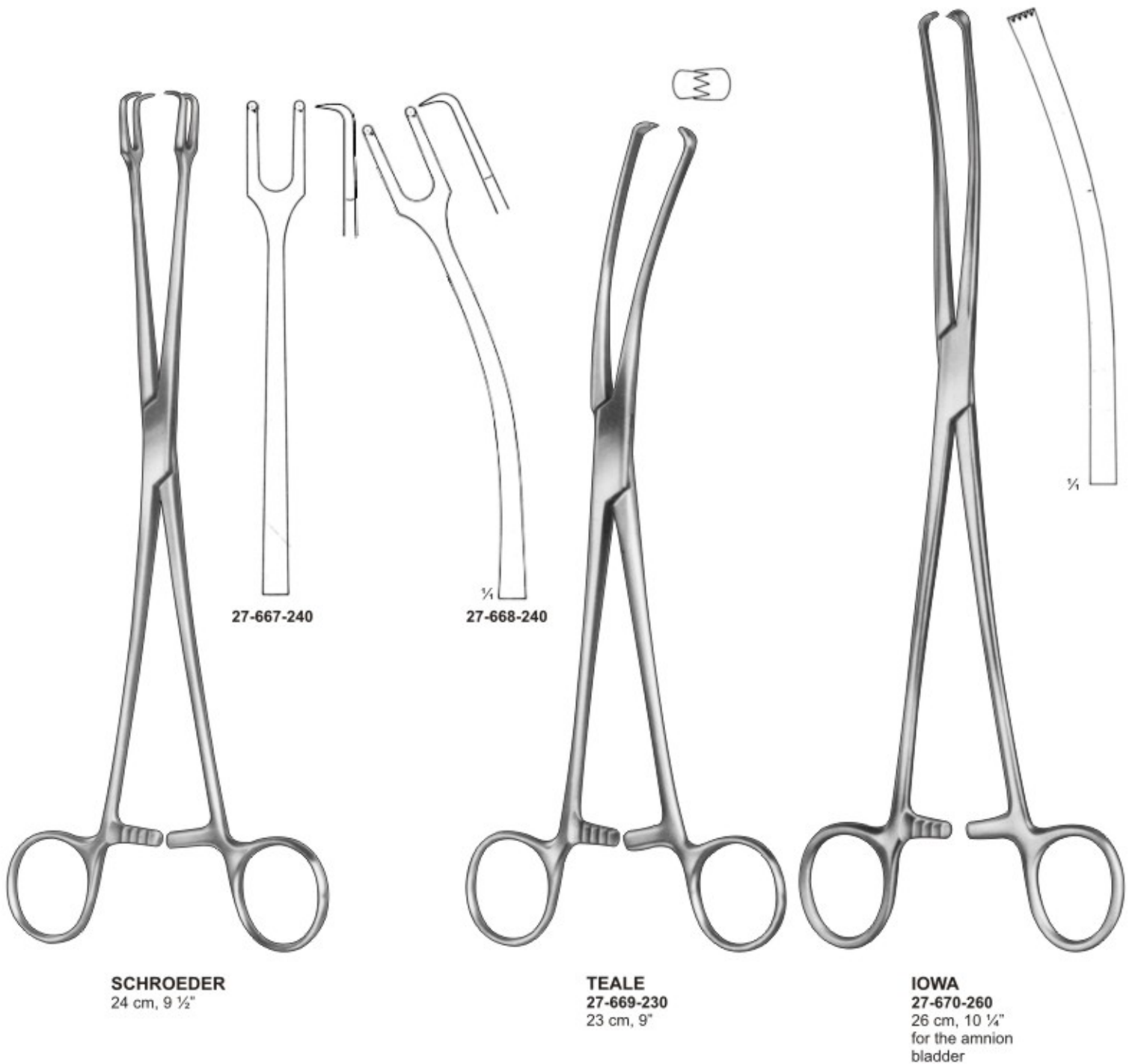

# TONSIL FORCEPS



Tonsillenklemmen  
Pinzas Para Amigdalas

Pinces Pour Amygdalas  
Pinze Per Tonsille



6 mm  
27-671-240



8 mm  
27-672-240



10 mm  
27-673-240

**MUSEUX**  
24 cm, 9 1/2"

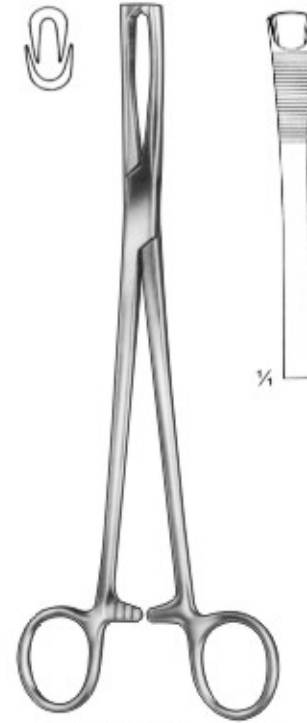

1/4"

**JACOBS**  
27-674-210  
21 cm, 8 1/4"

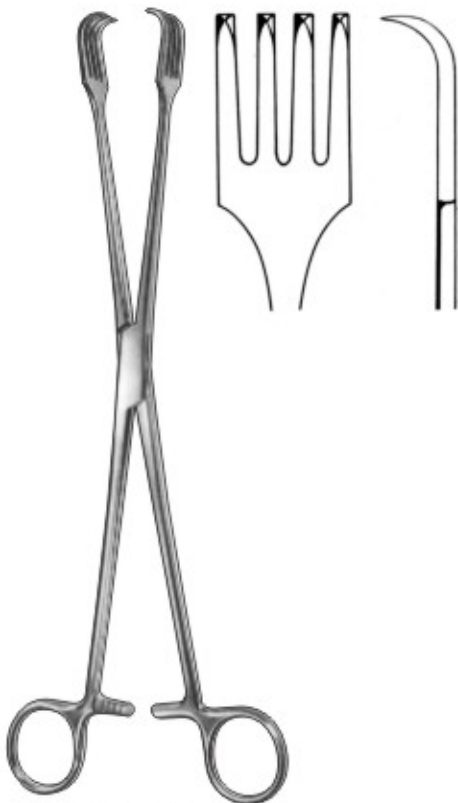

**27-675-260**  
26 cm, 10 1/4"



**BRAUN**  
27-676-155  
15.5 cm, 6 1/4"



**CZERNY**  
27-677-205  
20.5 cm, 8 1/4"





## TONSIL DISSECTOR

Tonsillenelevator/Retraktor  
Disector/Reparador Para Amígdalas

Dissecteur/Rétracteur Pour Amygdales  
Disettori/Retrattori Per Tonsille



**HENKE**  
Tonsil dissector  
and retractor  
27-678-230  
23 cm 9"

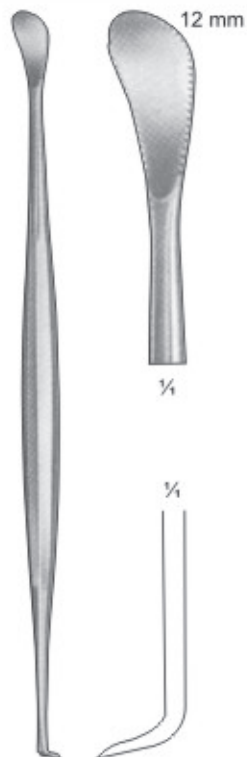

**HENKE**  
Tonsil dissector and  
pillar retractor  
27-679-230  
23 cm 9"



**GAYNE EVANS**  
Tonsil dissector,  
double-ended  
27-680-200  
20 cm 8"

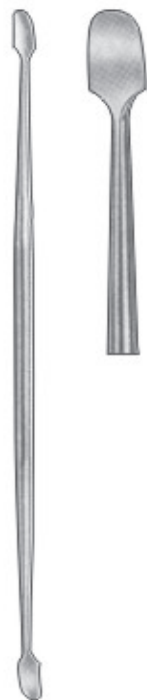

**SYME**  
Tonsil dissector, blunt  
and semi-sharp  
27-681-185  
18.5 cm 7 1/4"



**MOLLINSON**  
Tonsil dissector and  
pillar retractor, sharp  
semi  
27-682-225 22.5 cm 9"



**LUNIATSCHECK**  
27-683-190  
19 cm, 7 1/2"

# TONSIL DISSECTOR



Tonsillenelevator/Retraktor  
Disector/Reparador Para Amígdalas

Dissecteur/Rétracteur Pour Amygdales  
Disettori/Retrattori Per Tonsille

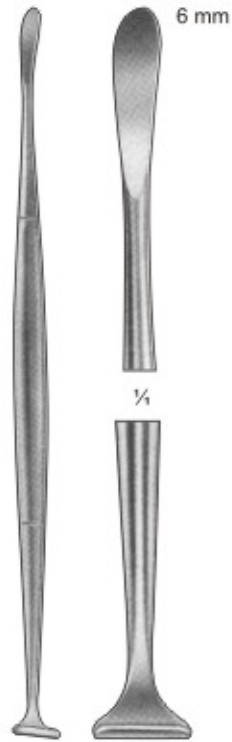

**HARD**  
Tonsil dissector and  
pillar retractor  
27-684-215 21.5 cm 8 1/2"

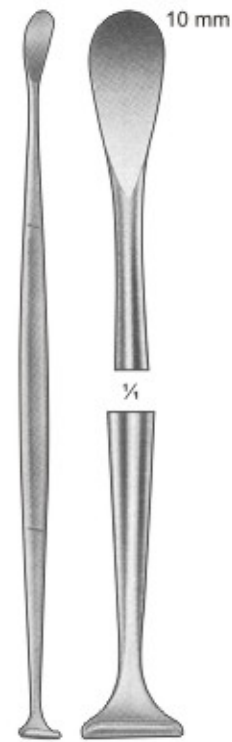

**HARD**  
Tonsil dissector and  
pillar retractor  
27-685-215 21.5 cm 8 1/2"

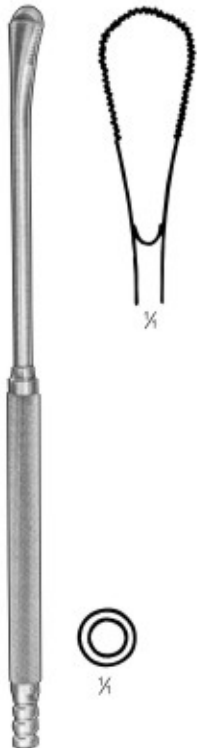

**LORER-REINKE**  
Tonsil suction dissector  
27-686-235 23.5 cm 9 1/4"



**KOCHER**



27-687-150  
15 cm, 6"  
27-688-160  
16 cm, 6 1/4"



27-689-150  
15 cm, 6"  
27-690-160  
16 cm, 6 1/4"



27-691-180  
18 cm, 7"



## TONSIL SNARES

Tonsillenschnürer  
Cierra-nudos Para Amígdalas

Serre-noeuds Pour Amygdalas  
Serranodi Per Tonsille

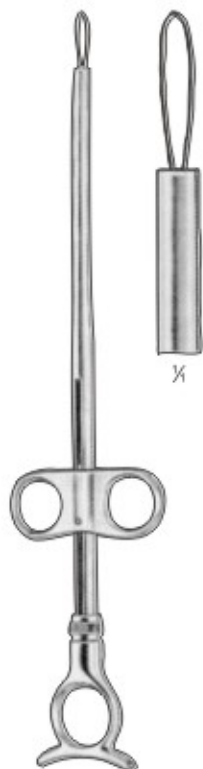

**EVES**  
27-692-280  
28 cm, 11"



**EVES**  
27-693-280  
28 cm, 11"

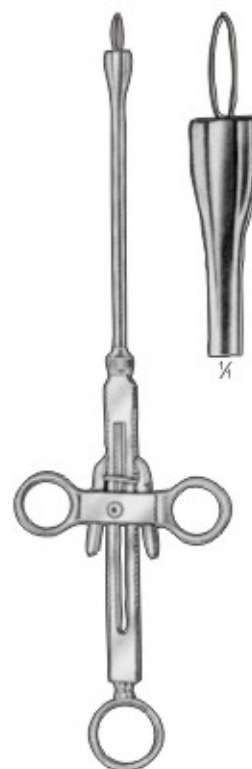

**BRUENINGS**  
27-694-280  
28 cm, 11"



Pack. Of 100 pcs.  
27-695-001 = 40mm  
27-696-002 = 50mm



Pack. Of 12 pcs.  
27-697-001 = 0.3mm Ø

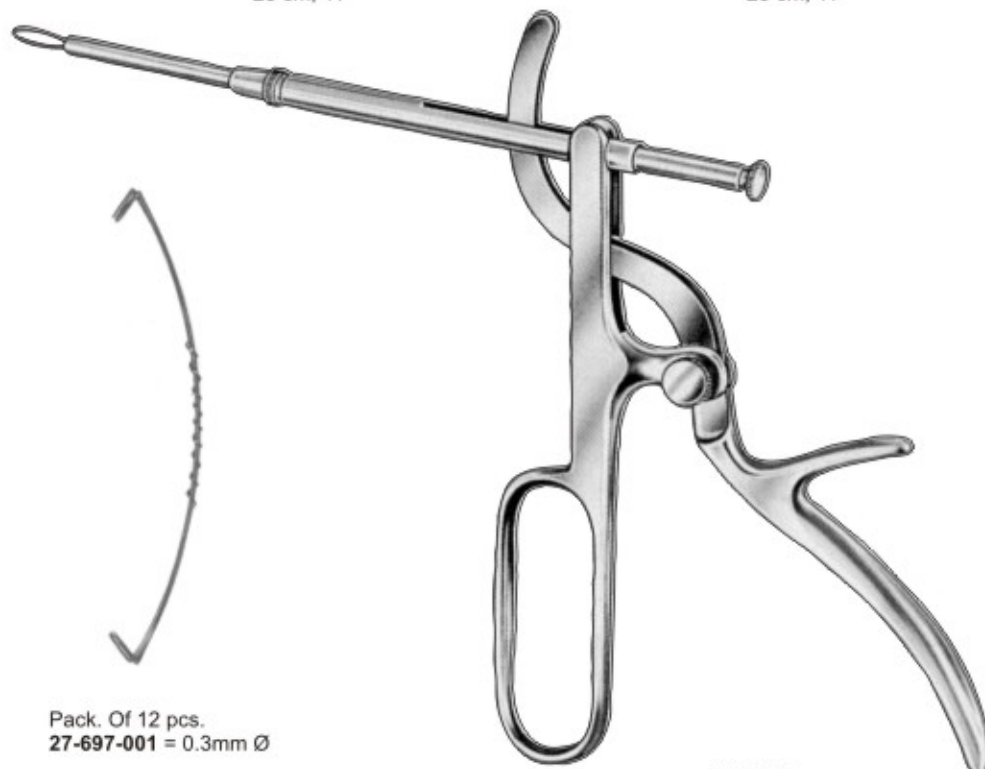

**TYDING**  
27-698-001

Tonsillenschnürer  
Cierra-nudos Para Amígdalas

# TONSIL SNARES

Serre-noeuds Pour Amygdalas  
Serranodi Per Tonsille



Complete, with 3 tips fig. 1-3



27-699-001



27-700-002



27-701-003



**SLUDER-BALLENGER**

27-702-004

complete, with 3 tips fig. 1-3  
Blades For Tonsillotome Handle



**RODER**

27-703-265

26.5 cm, 10 1/2"



**HOFER**

27-704-240

24 cm, 9 1/2"



**NAGER**

27-705-230

23 cm, 9"



**LOVE**

27-706-180

18 cm, 7"

27-707-200

20 cm, 8"

27-708-220

22 cm, 8 1/2"



**HASLINGER**

27-709-170

17 cm, 6 3/4"



**MATIN**

27-710-170

17 cm, 6 3/4"



# SINUS AND ETHMOID CURETTES

Curettes pour sinus et ethmoïde  
Nasennebenhöhlen- und siebbeinküretten

Curette per etmoide e seni nasali  
Curetas para la etmoides y el seno nasal



**27-711-165**  
Slightly angled  
16.5 cm, 6 1/2"



**27-712-165**  
Slightly angled 45°  
16.5 cm, 6 1/2"



**27-713-150**  
Slightly angled 90°  
15 cm, 6"



**27-714-150**  
Straight oval jaw.  
15 cm, 6"



**27-715-165**  
angled 45°  
16.5 cm, 6 1/2"



**27-716-150**  
Slightly angled  
15 cm, 6"

Up

Down



**27-717-245**  
Straight angled 45°  
24.5 cm, 10"



**27-718-250**  
angled 45°  
25.0 cm, 10"



**27-719-235**  
angled 90°  
23.5 cm, 9 1/2"

## COAKLEY SINUS CURETTES

## COAKLEY SINUS CURETTES



**PRATT ETHMOID CURETTES**  
**27-720-220**  
22 cm, 8 3/4"



**FAULKNER ETHMOID CURETTES**  
**27-721-222**  
22.2 cm, 8 3/4"

# ADENOID CURETTES



Ringmesser  
Cuchillos Para Adenoidse

Couteaux à Végétations Adenoïdales  
Coltelli Per Vegetazioni Adenoidee



27-722-001



27-723-002



27-728-001



27-729-002



27-724-003



27-725-004



27-730-003



27-731-004



27-726-005



27-727-006



27-732-006



27-733-006

**Beckmann**  
22 cm, 8 3/4"

**Beckmann (Negus)**  
22 cm, 8 3/4"



27-734-220



27-735-220



27-736-220



27-737-220

**BARNHILL**  
22 cm, 8 3/4"



27-738-210



27-739-210



27-740-210



27-741-210

**ST. CLAIR-THOMSON**  
21cm, 8 1/4"



27-742-230



27-743-230



27-744-230

**LA FORCEPS**  
Adenotomes  
23 cm, 9"



## LARYNGEAL MIRRORS, LARYNGEAL MIRROR HANDLES

*Kehlkopfspiegel, Kehlkopfspiegel-griffe*  
*Espejos Laringeos, Mangos Para Espejos Laringeos*

*Miroirs Laryngiens, Manche Pour Miroirs Laryngiens*  
*Specchi Laringei, Manico Per Specchi Laringei*



**LARYNGEAL  
MIRROR**  
with Handle



**27-745-001**  
fig 00 = 8mm



**27-746-002**  
fig 0 = 10mm



**27-747-003**  
fig 1 = 12mm



**27-748-004**  
fig 2 = 14mm

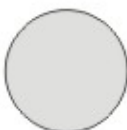

**27-749-005**  
fig 3 = 16mm

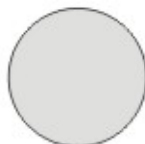

**27-750-006**  
fig 4 = 18mm

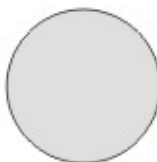

**27-751-007**  
fig 5 = 20mm

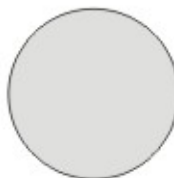

**27-752-008**  
fig 6 = 22mm

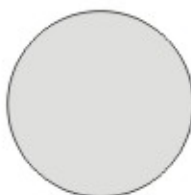

**27-753-009**  
fig 7 = 24mm

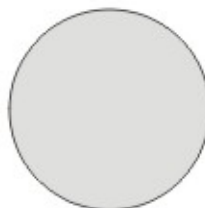

**27-754-010**  
fig 8 = 26mm

# TRACHEAL TUBES



Trachealkanülen  
Cánulas Traqueales

Canules Tracheales  
Cannule Tracheali



**LUER**

Fig.	mm $\varnothing$	N 46-90 mm	M 95 mm	R 46-90 mm
0	4 mm	27-755-004		
1	5 mm	27-756-005		
2	6 mm	27-757-006		
3	7 mm	27-758-007		
4	8 mm	27-759-008	27-765-008	27-771-008
5	9 mm	27-760-009	27-766-009	27-772-009
6	10 mm	27-761-010	27-767-010	27-773-010
7	11 mm	27-762-011	27-768-011	27-774-011
8	12 mm	27-763-012	27-769-012	27-775-012
9	13 mm	27-764-013	27-770-013	27-776-013



**CHEVALIER-JACKSON**

Fig.	mm $\varnothing$	N 46-90 mm
0	4 mm	27-777-004
1	5 mm	27-778-005
2	6 mm	27-779-006
3	7 mm	27-780-007
4	8 mm	27-781-008
5	9 mm	27-782-009
6	10 mm	27-783-010
7	11 mm	27-784-011
8	12 mm	27-785-012
9	13 mm	27-786-013



**SPEAKING TUBE**  
outer tube closed  
inner tube closed  
27-787-001

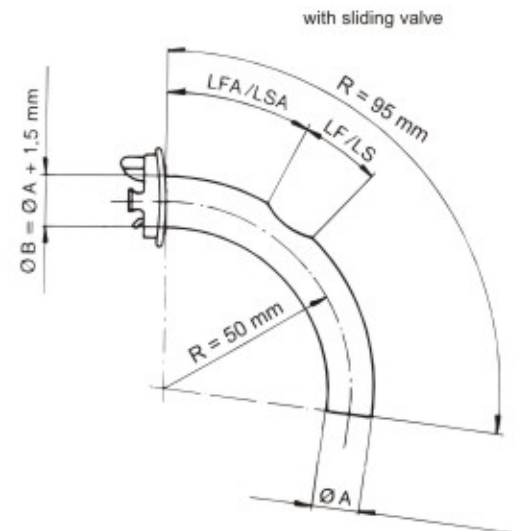
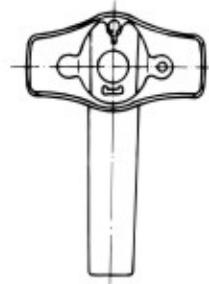

Fig.	Item	$\varnothing A$	L	Radius
A	27-788-008	08mm	95mm	50mm
A	27-789-009	09mm	95mm	50mm
A	27-790-010	10mm	95mm	50mm
A	27-791-011	11mm	95mm	50mm
A	27-792-012	12mm	95mm	50mm
A	27-793-013	13mm	95mm	50mm





## TONGUE HOLDING FORCEPS, TRACHEOTOMY TROCAR

Zungenzangen, Trachealtrokar  
Pinzas Tira-lengua, Traqueótomo

Pinces Tire-langue, Trocart Pour La Trachéotomie  
Pinze Per Lingua, Trequarto Per Tracheotomia

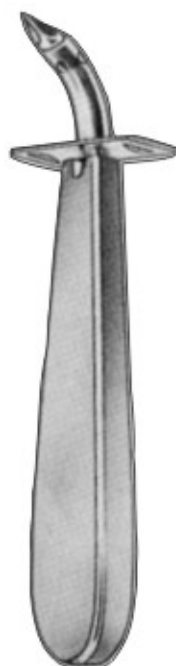

27-794-130  
7.5mm



27-795-130  
9mm

**UCKERMANN**  
13 cm, 5 1/4"

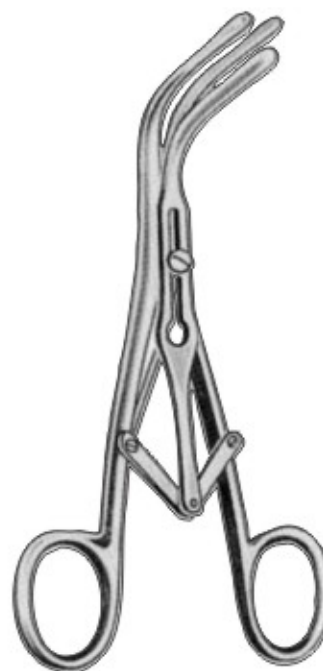

**LABORDE**  
27-796-140  
14 cm, 5 1/2"



**TROUSSEAU**  
27-797-140  
14 cm, 5 1/2"



27-799-001  
pair

**YOUNG**  
27-798-170  
16 cm, 6 1/4"

# ALAR HOOKLETS, NASAL RETRACTORS



Nasenflügelhäkchen, Nasenhaken  
Ganchitos Para Alas De Nariz, Separadores Nasales,

Crochets Pour Les Ailes Du Nez, Ecarteurs Nasaux  
Uncini Per Le Pinne Nasali, Divaricatori Nasali



**HOOK RETRACTOR,**  
27-800-160  
single, blunt  
16 cm, 6 1/4"

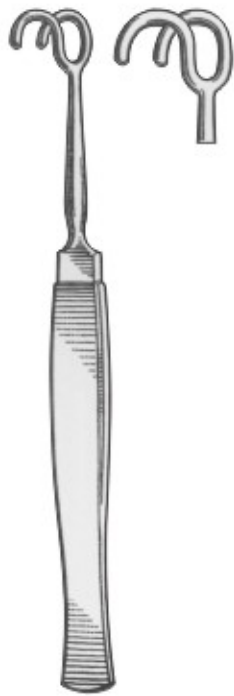

**HOOK RETRACTOR,**  
27-801-160  
double, blunt  
16 cm, 6 1/4"



**ROSE**  
27-802-130  
13 cm, 5 1/4"



**LUER**  
27-803-110  
11 cm, 4 1/4"



**JACKSON**  
27-804-150  
15 cm, 6"



**NEWS**  
27-805-150  
15 cm, 6"



Left

**BOSE**  
27-806-160  
16 cm, 6 1/4"



Right

**BOSE**  
27-807-160  
16 cm, 6 1/4"



**ITERSON**  
16 cm, 6 1/4"



27-808-160  
Sharp



27-809-160  
Blunt



**SCHOENBORN**  
27-810-210  
21 cm, 8 1/4"



**LUKENS**  
27-811-170  
17 cm, 6 3/4"



## TRACHEOTOMY SET

Tracheotomie  
Traqueotomia

Tracheotomie  
Tracheotomia

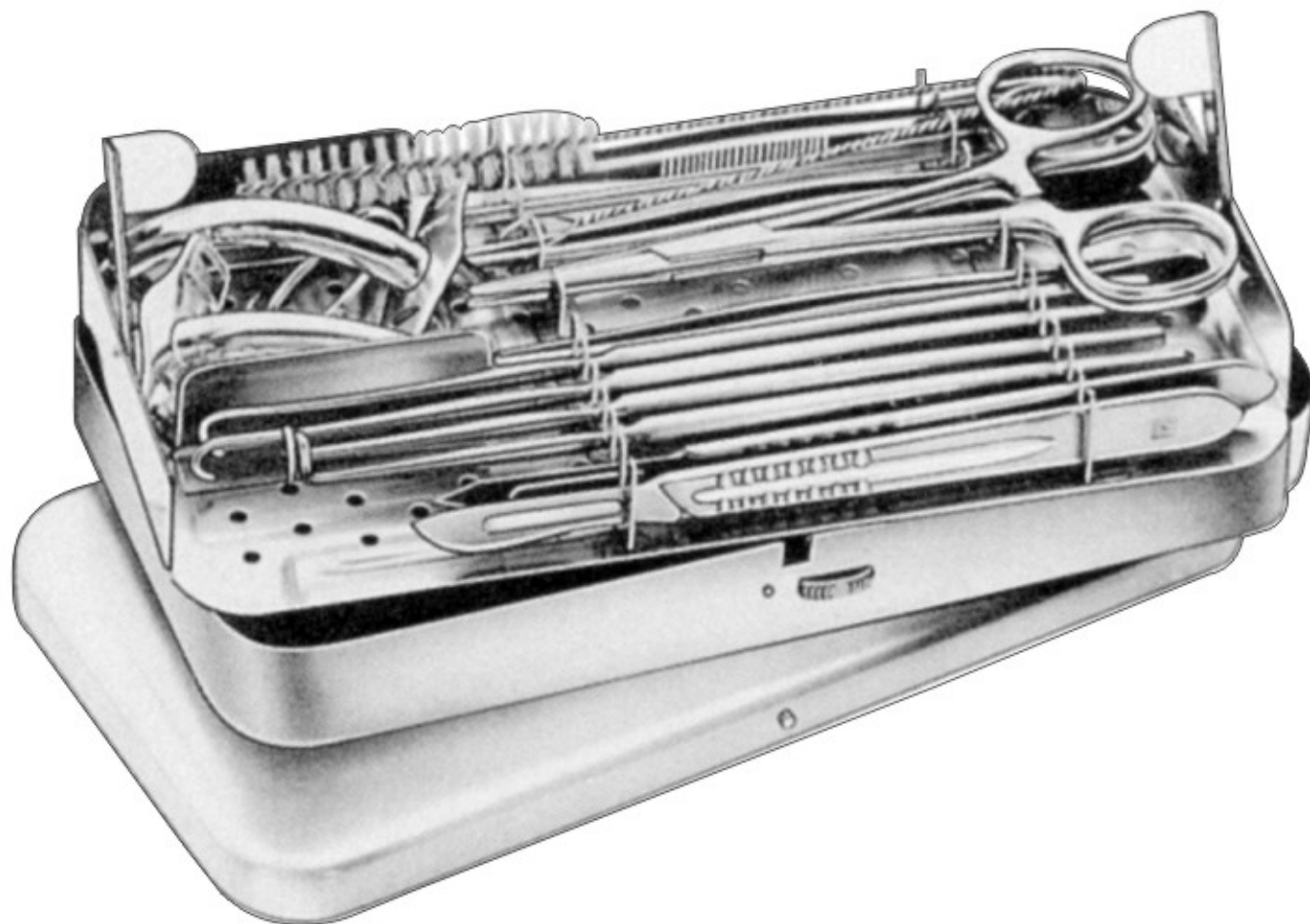

- |            |   |
|------------|---|
| 27-812-001 | 1 Metal Case                            |
|            | In Metal Case Consisting Of:            |
| 27-813-002 | 1 Handle With 1 Blade Fig. 20           |
| 27-814-003 | 1 Handle With 1 Blade Fig. 23           |
| 27-815-004 | 1 Thumb Forceps 13cm                    |
| 27-816-005 | 1 Tissue Forceps 13cm, 1 x 2 teeth      |
| 27-817-006 | 2 Pean Artery Forceps 13cm              |
| 27-818-007 | 1 Grooved Director 13cm                 |
| 27-819-008 | 1 Trachea Dilator                       |
| 27-820-009 | 2 Trachea Retractors, Iterson, Blunt    |
| 27-821-010 | 1 Trachea Retractor, Bose, Sharp, Left  |
| 27-822-011 | 1 Trachea Retractor, Bose, Sharp, Right |
| 27-823-012 | 1 Luer Trachea Tube Standard            |
| 27-824-013 | 1 Luer Trachea Tube Standard            |
| 27-825-014 | 1 Cleaning Brush                        |

# UNIVERSAL LARYNGEAL



*Manche laryngien universel  
Kehlkopf-universalgriffe*

*Manici, tubi e punte universali per strumenti chirurgici per laringe  
Mangos, tubos y puntas universales para laringe*



**27-826-001**  
Chest Support and **LARYNGOSCOPE HOLDER**,  
complete, for adults and children

**27-827-180**  
18 cm, 7"  
Operating Laryngoscope,  
for adults, large



**27-828-180**  
18 cm, 7"  
Operating Laryngoscope,  
for adults, medium



**27-829-130**  
13 cm, 5"  
Operating Laryngoscope,  
for children



**27-830-180**  
18 cm, 7"  
Operating Laryngoscope,  
for adults, small



**27-831-001**  
Light guide for use  
**LARYNGOSCOPES**



**27-832-001**  
Light guide for use  
**LARYNGOSCOPES**

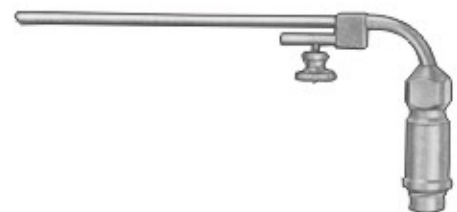



## BIOPSY PUNCHES

Perforateurs pour biopsie  
Biopsiestanzen

Puntruoli per biopsia  
Perforadores para biopsias



**JATHO**  
27-833-220  
22 cm, 8 3/4"  
Biopsy forceps  
right side opening

27-834-220  
22 cm, 8 3/4"  
Biopsy forceps  
left side opening

**JATHO**  
Nasopharynx  
Forceps  
27-835-240  
24 cm, 9 1/2"



**JURASZ**  
27-836-230 lateral biting to the right  
27-837-230 lateral biting to the left  
27-838-230 downwards biting  
27-839-230 upwards biting  
23 cm, 9"  
Laryngeal Polypus Forceps



27-836-230



27-837-230



27-838-230



27-839-230



**TOBOLD**  
27-840-230  
Laryngeal polypus forceps,  
curved sideways  
23 cm, 9"

# BRONCHO-ESOPHAGOSCOPY FORCEPS

Broncho-Oesophagoskopiezangen  
Pinzas Para Broncho-Esofagoscopia

Pinces Pour Broncho-Esophagoscopie  
Pinze Per Broncho-Esofagoscopia



**BRÜNINGS**  
27-841-001  
Universal handle, with lever  
on the left, for use with  
tubes  
27-842-200 to  
27-843-500



**AESCULAP**  
27-844-001  
14 cm, 5 1/2"  
Universal handle, with lever  
on the right, for use with  
tubes  
27-845-200 to  
27-846-500

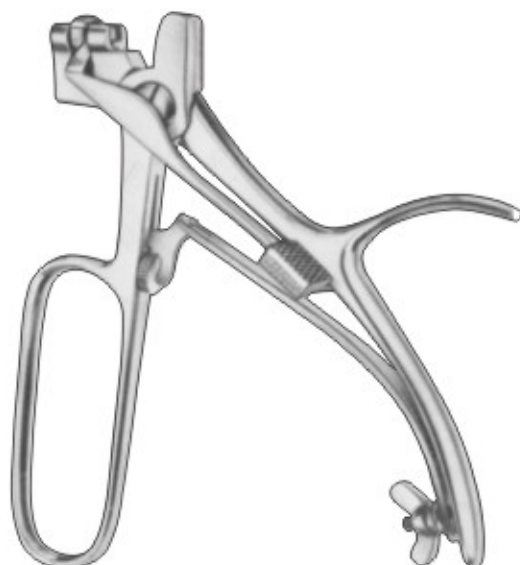

**HUBER**  
27-847-001  
14 cm, 5 1/2"  
Universal handle, with lever  
on the right, for use with  
tubes  
27-848-200 to  
27-849-500



**BRÜNINGS**  
27-850-200  
20 cm, 8"  
Curved Tube with Stylet,



**BRÜNINGS**  
27-851-200 20 cm, 8"  
27-852-250 25 cm, 10"  
27-853-300 30 cm, 12"  
27-854-350 35 cm, 14"  
27-855-400 40 cm, 16"  
27-856-500 50 cm, 20"  
Straight Tubes with  
Stylet, stiff



# EXCHANGEABLE TIPS FOR BRONCHO-ESOPHAGOSCOPY FORCEPS

Auswechselbare Zangenaufsätze, Broncho-Oesophagoskopiezangen  
Pinzas Intercambiables, Pinzas Para Broncho-Esofagoscopia

Embouts Interchangeables, Pincas Pour Broncho-Esophagoscopie  
Pinze Intercambiabili, Pinze Per Broncho-Esofagoscopia

27-857-001



**LANGE**  
27-869-013



27-858-002



**KRAUSE**  
27-870-014  
27-871-015

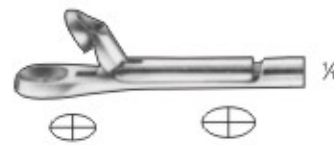

**KAHLER**  
27-859-003



**EICKEN**  
27-860-004



**SCHEINMANN**  
27-872-016



**FRAENKEL**  
27-861-005

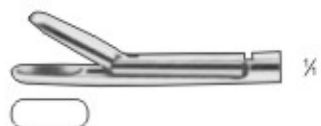

**SCHEINMANN**  
27-873-017



**FRAENKEL**  
27-862-006



**SCHEINMANN**  
27-863-007

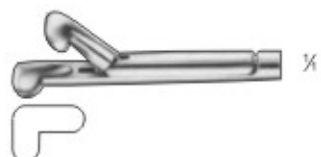

**CORDES**  
27-874-018



**BRÜNINGS**  
27-864-008 Ø 2 mm.  
27-865-009 Ø 3 mm.  
27-866-010 Ø 4 mm.



**CORDES**  
27-875-019



**BRÜNINGS**  
27-867-011



**ROSENBRG**  
27-876-020



**LANGE**  
27-868-012



**STRUYCKEN**  
27-877-021



# HOLLOW WARES



- KIDNEY TRAYS
- INSTRUMENTS BOXES
- STERILIZING DRUMS
- MESH BASKETS
- JARS

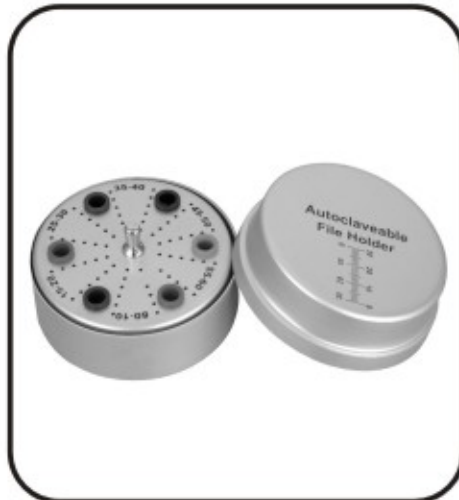





## STERILIZING DRUMS



### STERILIZING DRUMS

	Ø mm	h mm
35-001-001	80	80
35-002-002	120	120
35-003-003	160	120
35-004-004	190	140
35-005-005	190	200
35-006-006	240	120
35-007-007	240	160
35-008-008	240	240
35-009-009	290	120
35-010-010	290	160
35-011-011	290	240
35-012-012	340	160
35-013-013	340	240
35-014-014	390	145
35-015-015	390	200
35-016-016	390	290



### STERILIZING DRUM

	Ø mm	h mm
35-017-001	150 x 150	150
35-018-002	175 x 175	175
35-019-003	190 x 190	190
35-020-004	200 x 140	140
35-021-005	200 x 200	200
35-022-006	240 x 120	120
35-023-007	225 x 225	225
35-024-008	240 x 240	240
35-025-009	290 x 160	160
35-026-010	280 x 240	240
35-027-011	230 x 150	150
35-028-012	300 x 250	250
35-029-013	340 x 250	250
35-030-014	350 x 250	250
35-031-015	390 x 200	200



### STERILIZING DRUM

	Ø mm	h mm
35-032-001	150 x 150	150
35-033-002	175 x 175	175
35-034-003	190 x 190	190
35-035-004	200 x 140	140
35-036-005	200 x 200	200
35-037-006	240 x 120	120
35-038-007	225 x 225	225
35-039-008	240 x 240	240
35-040-009	290 x 160	160
35-041-010	280 x 240	240
35-042-011	230 x 150	150
35-043-012	300 x 250	250
35-044-013	340 x 250	250
35-045-014	350 x 250	250
35-046-015	390 x 200	200



### STERILIZING DRUM

	Ø mm	h mm
35-047-001	150 x 150	150
35-048-002	175 x 175	175
35-049-003	190 x 190	190
35-050-004	200 x 140	140
35-051-005	200 x 200	200
35-052-006	240 x 120	120
35-053-007	225 x 225	225
35-054-008	240 x 240	240
35-055-009	290 x 160	160
35-056-010	280 x 240	240
35-057-011	230 x 150	150
35-058-012	300 x 250	250
35-059-013	340 x 250	250
35-060-014	350 x 250	250
35-061-015	390 x 200	200



### STERILIZING DRUM

	Ø mm	h mm
35-062-001	150 x 150	150
35-063-002	175 x 175	175
35-064-003	190 x 190	190
35-065-004	200 x 140	140
35-066-005	200 x 200	200
35-067-006	240 x 120	120
35-068-007	225 x 225	225
35-069-008	240 x 240	240
35-070-009	290 x 160	160
35-071-010	280 x 240	240
35-072-011	230 x 150	150
35-073-012	300 x 250	250
35-074-013	340 x 250	250
35-075-014	350 x 250	250
35-076-015	390 x 200	200



**G LOVES BOX**  
35-077-001  
300 x 150 mm



**INSTRUMENT TRAY WITH COVER**  
35-078-001

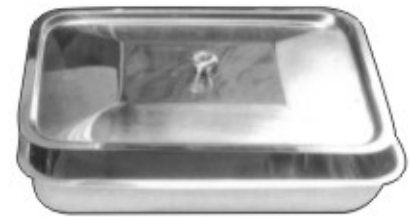

**INSTRUMENT TRAY**  
35-079-001



**CATHER TRAY**

	Size
35-080-001	230 x 75 mm
35-081-002	350 x 90 mm
35-082-003	430 x 100 mm
35-083-004	200 x 100 mm
35-084-005	300 x 100 mm
35-085-006	350 x 100 mm

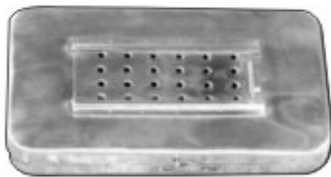

**PERFORATED BOX**

	Size
35-087-001	100 x 50 mm
35-088-002	165 x 65 mm
35-089-003	250 x 100 mm
35-090-004	250 x 150 mm
35-091-005	250 x 200 mm
35-092-006	150 x 65 mm
35-093-007	170 x 70 mm
35-094-008	200 x 100 mm
35-095-009	250 x 125 mm
35-096-010	300 x 150 mm
35-097-011	300 x 200 mm
35-098-012	300 x 130 mm
35-099-013	320 x 150 mm
35-100-014	420 x 180 mm
35-101-015	460 x 125 mm
35-102-016	355 x 180 mm
35-103-017	300 x 180 mm
35-104-018	400 x 200 mm
35-105-019	510 x 200 mm

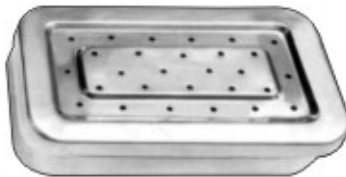

**BOX WITH FILTER**

	Size
35-106-001	100 x 50 mm
35-107-002	165 x 65 mm
35-108-003	250 x 100 mm
35-109-004	250 x 150 mm
35-110-005	250 x 200 mm
35-111-006	150 x 65 mm
35-112-007	170 x 70 mm
35-113-008	200 x 100 mm
35-114-009	250 x 125 mm
35-115-010	300 x 150 mm
35-116-011	300 x 200 mm
35-117-012	300 x 130 mm
35-118-013	320 x 150 mm
35-119-014	420 x 180 mm
35-120-015	460 x 125 mm
35-121-016	355 x 180 mm
35-122-017	300 x 180 mm
35-123-018	400 x 200 mm
35-124-019	510 x 200 mm



**INSTRUMENTS BOX**

Without Clip	Size
35-125-001	100 x 50 mm
35-126-002	165 x 65 mm
35-127-003	250 x 100 mm
35-128-004	250 x 150 mm
35-129-005	250 x 200 mm
35-130-006	150 x 65 mm
35-131-007	170 x 70 mm
35-132-008	200 x 100 mm
35-133-009	250 x 125 mm
35-134-010	300 x 150 mm
35-135-011	300 x 200 mm
35-136-012	300 x 130 mm
35-137-013	320 x 150 mm
35-138-014	420 x 180 mm
35-139-015	460 x 125 mm
35-140-016	355 x 180 mm
35-141-017	300 x 180 mm
35-142-018	400 x 200 mm
35-143-019	510 x 200 mm



**INSTRUMENT BOX**

With Clip	Size
35-144-001	100 x 50 mm
35-145-002	165 x 65 mm
35-146-003	250 x 100 mm
35-147-004	250 x 150 mm
35-148-005	250 x 200 mm
35-149-006	150 x 65 mm
35-150-007	170 x 70 mm
35-151-008	200 x 100 mm
35-152-009	250 x 125 mm
35-153-010	300 x 150 mm
35-154-011	300 x 200 mm
35-155-012	300 x 130 mm
35-156-013	320 x 150 mm
35-157-014	420 x 180 mm
35-158-015	460 x 125 mm
35-159-016	355 x 180 mm
35-160-017	300 x 180 mm
35-161-018	400 x 200 mm
35-162-019	510 x 200 mm



## HOLLOWARE INSTRUMENTS

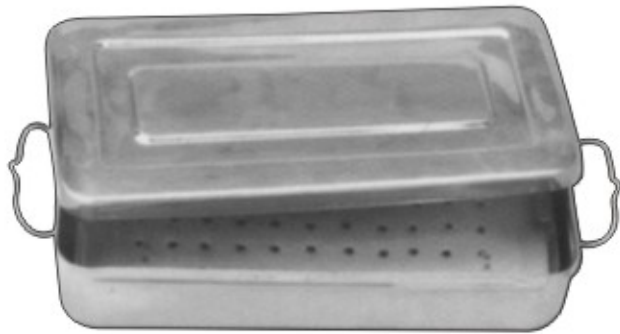

### INSTRUMENT BOILER

	Size
35-163-001	180 x 80 x 40 mm
35-164-002	200 x 100 x 50 mm
35-165-003	250 x 125 x 40 mm
35-166-004	300 x 150 x 60 mm
35-167-005	350 x 175 x 75 mm
35-168-006	400 x 200 x 100 mm



### PERFORATED TRAY

	Size
35-169-001	180 x 80 x 40 mm
35-170-002	200 x 100 x 50 mm
35-171-003	250 x 125 x 40 mm
35-172-004	300 x 150 x 60 mm
35-173-005	350 x 175 x 75 mm
35-174-006	400 x 200 x 100 mm



### INSTRUMENT BOILER WITH STAND

	Size
35-175-001	180 x 80 x 40 mm
35-176-002	200 x 100 x 50 mm
35-177-003	250 x 125 x 40 mm
35-178-004	300 x 150 x 60 mm
35-179-005	350 x 175 x 75 mm
35-180-006	400 x 200 x 100 mm



### INSTRUMENT BOILER ELECTRIC

	Size
35-181-001	180 x 80 x 40 mm
35-182-002	200 x 100 x 50 mm
35-183-003	250 x 125 x 40 mm
35-184-004	300 x 150 x 60 mm
35-185-005	350 x 175 x 75 mm
35-186-006	400 x 200 x 100 mm



**NEEDLE CASE**  
35-187-001  
230 x 125 mm

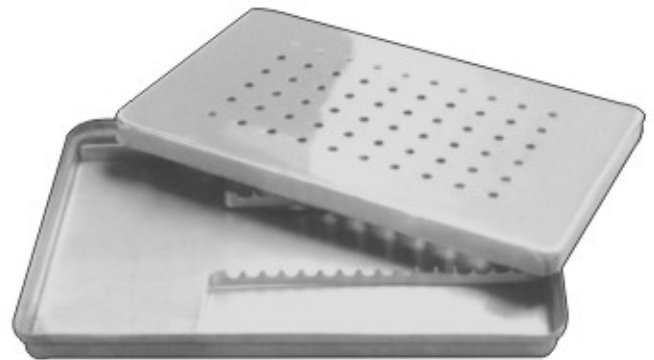

**SCALER BOX**  
35-188-001  
300 x 180 mm



**SCALER TRAY**  
35-189-001  
100 x 200 mm



**INDO BOX WITH SILVER FRAME**  
35-191-001



**Autoclaveable**  
35-190-001

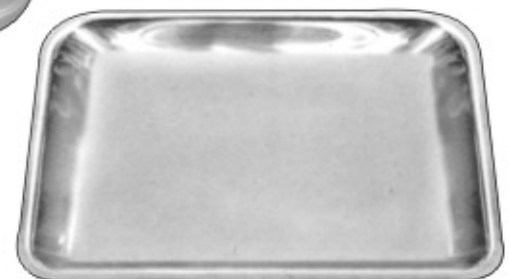

**INSTRUMENT TRAY WITHOUT COVER**

	Size		Size
35-192-001	240 x 240 mm	35-203-012	230 x 125 mm
35-193-002	355 x 400 mm	35-204-013	200 x 150 mm
35-194-003	300 x 150 mm	35-205-014	250 x 200 mm
35-195-004	300 x 180 mm	35-206-015	300 x 250 mm
35-196-005	300 x 240 mm	35-207-016	350 x 300 mm
35-197-006	340 x 320 mm	35-208-017	400 x 350 mm
35-198-007	230 x 180 mm	35-209-018	450 x 300 mm
35-199-008	250 x 130 mm	35-210-019	300 x 200 mm
35-200-009	200 x 130 mm	35-211-020	350 x 250 mm
35-201-010	180 x 130 mm	35-212-021	250 x 125 mm
35-202-011	150 x 100 mm	35-213-022	200 x 100 mm
		35-214-023	400 x 200 mm

**INSTRUMENT TRAY WITHOUT COVER**

	Size		Size
35-215-001	240 x 240 mm	35-226-012	230 x 125 mm
35-216-002	355 x 400 mm	35-227-013	200 x 150 mm
35-217-003	300 x 150 mm	35-228-014	250 x 200 mm
35-218-004	300 x 180 mm	35-229-015	300 x 250 mm
35-219-005	300 x 240 mm	35-230-016	350 x 300 mm
35-220-006	340 x 320 mm	35-231-017	400 x 350 mm
35-221-007	230 x 180 mm	35-232-018	450 x 300 mm
35-222-008	250 x 130 mm	35-233-019	300 x 200 mm
35-223-009	200 x 130 mm	35-234-020	350 x 250 mm
35-224-010	180 x 130 mm	35-235-021	250 x 125 mm
35-225-011	150 x 100 mm	35-236-022	200 x 100 mm
		35-237-023	400 x 200 mm



# HOLLOWWARE INSTRUMENTS



**KIDNEY TRAY WITH COVER**  
(English Pattern)

	Size
35-238-001	150 mm
35-239-002	200 mm
35-240-003	240 mm
35-241-004	300 mm



**KIDNEY TRAY (German Pattern)**  
(without cover)

	Size
35-242-001	150 mm
35-243-002	200 mm
35-244-003	240 mm
35-245-005	300 mm



**SPLIT LAMP**  
35-246-001  
100 ml.



**BOWL**

	Size
35-247-001	80 mm
35-248-002	100 mm
35-249-003	125 mm
35-250-004	150 mm
35-251-005	200 mm
35-252-006	250 mm
35-253-007	300 mm
35-254-008	350 mm
35-255-009	400 mm



**WASH BASIN**

	Size
35-256-001	80 mm
35-257-002	100 mm
35-258-003	125 mm
35-259-004	150 mm
35-260-005	200 mm
35-261-006	250 mm
35-262-007	300 mm
35-263-008	350 mm
35-264-009	400 mm

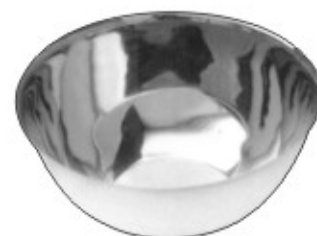

**BOWL**

	Size
35-265-001	80 mm
35-266-002	100 mm
35-267-003	125 mm
35-268-004	150 mm
35-269-005	200 mm
35-270-006	250 mm
35-271-007	300 mm
35-272-008	350 mm
35-273-009	400 mm



**DRESSING JAR WITH KNOB**

	Size
35-274-001	80 x 80 mm
35-275-002	100 x 100 mm
35-276-003	125 x 125 mm
35-277-004	150 x 150 mm
35-278-005	200 x 200 mm



**DRESSING JAR**

	Size
35-279-001	80 x 80 mm
35-280-002	100 x 100 mm
35-281-003	125 x 125 mm
35-282-004	150 x 150 mm
35-283-005	200 x 200 mm



**DRESSING JAR**

	Size
35-284-001	80 x 80 mm
35-285-002	100 x 100 mm
35-286-003	125 x 125 mm
35-287-004	150 x 150 mm
35-288-005	200 x 200 mm



**DRESSING JAR**

	Size
35-289-001	80 x 80 mm
35-290-002	100 x 100 mm
35-291-003	125 x 125 mm
35-292-004	150 x 150 mm
35-293-005	200 x 200 mm



**FORCEPS  
JAR**

	Size
35-294-001	55 x 100 mm
35-295-002	55 x 140 mm
35-296-003	55 x 170 mm
35-297-004	55 x 180 mm
35-298-005	80 x 100 mm



**FORCEPS  
JAR**

	Size
35-299-001	55 x 100 mm
35-300-002	55 x 140 mm
35-301-003	55 x 170 mm
35-302-004	55 x 180 mm
35-303-005	80 x 100 mm



**FORCEPS  
JAR**

	Size
35-304-001	55 x 100 mm
35-305-002	55 x 140 mm
35-306-003	55 x 170 mm
35-307-004	55 x 180 mm
35-308-005	80 x 100 mm



**FORCEPS  
JAR**

	Size
35-309-001	55 x 100 mm
35-310-002	55 x 140 mm
35-311-003	55 x 170 mm
35-312-004	55 x 180 mm
35-313-005	80 x 100 mm



**FORCEPS  
JAR**

	Size
35-314-001	55 x 100 mm
35-315-002	55 x 140 mm
35-316-003	55 x 170 mm
35-317-004	55 x 180 mm
35-318-005	80 x 100 mm



**COTTON HOLDER**  
35-319-001



**GALIPOTS**

	Capacity
35-320-001	2 Ounces
35-321-002	3 Ounces
35-322-003	4 Ounces
35-323-004	5 Ounces
35-324-005	6 Ounces
35-325-006	7 Ounces
35-326-007	8 Ounces



**GALIPOTS**

	Capacity
35-327-001	2 Ounces
35-328-002	3 Ounces
35-329-003	4 Ounces
35-330-004	5 Ounces
35-331-005	6 Ounces
35-332-006	7 Ounces
35-333-007	8 Ounces



**SPRIT LAMP**  
35-334-001  
100 ml.



**INDO BOX ROUND**  
35-335-001



**NEEDLE CASE**  
35-336-001



**MEASURING JUG**

	Capacity
35-337-001	1.00 Ltr
35-338-002	1.50 Ltr
35-339-003	2.00 Ltr



**MEDICINE CUP GRADUATED**

	Capacity
35-340-001	50 ml
35-341-002	60 ml
35-342-003	100 ml



**BUCKET WITH LID**

	Capacity
35-343-001	10 Ltr
35-344-002	12 Ltr
35-345-003	15 Ltr



## HOLLOWARE INSTRUMENTS



**SPUTUM MUG**  
35-346-001  
100 x 50 mm



**ENEMA CANE**  
Capacity  
35-347-001 0.5 Ltr  
35-348-002 1.5 Ltr  
35-349-003 2.0 Ltr



**DUST BIN**  
35-350-001  
20 Lit



**ROUND BADPAN**  
35-351-001  
300 x 85 mm



**BEDPAN**  
35-352-001  
Size: Adult, Child



**BEDPAN**  
35-353-001  
Size: Adult, Child



**FURNAL**  
35-354-001  
100 mm



**URINAL - FEMALE**  
35-355-001



**URINAL - MALE**  
35-356-001



**SHAVING MUG**  
35-357-001  
100 mm

# PERFORATED BASKETS

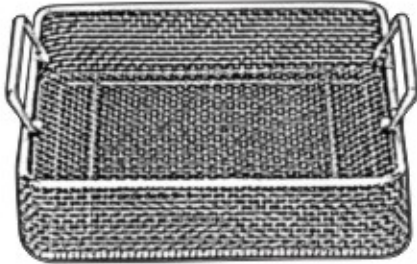

## MESH BASKET

- 35-358-001 240 x 258 x 50 mm
- 35-359-002 250 x 240 x 100 mm
- 35-360-003 240 x 250 x 60mm

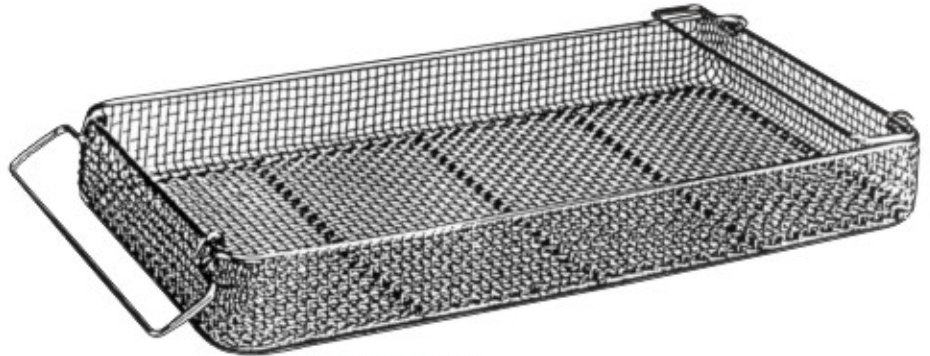

## MESH BASKET

- 35-361-001 480 x 258 x 50 mm
- 35-362-002 480 x 258 x 100 mm
- 35-363-003 520 x 258 x 60mm
- 35-364-004 520 x 258 x 70mm
- 35-365-005 450 x 340 x 70mm
- 35-366-006 320 x 230 x 70mm

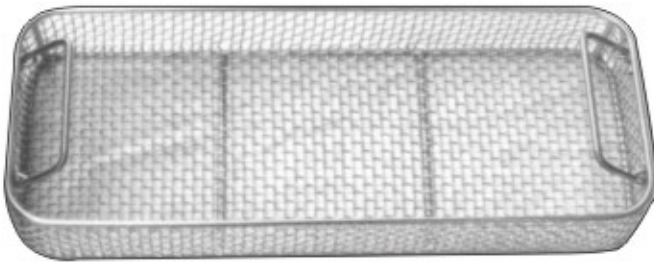

## MESH BASKET

With Perforated Sheet Side

- 35-367-001 230 x 130 x 50 mm
- 35-368-002 230 x 130 x 60 mm
- 35-369-003 240 x 130 x 50 mm
- 35-370-004 240 x 130 x 60 mm
- 35-371-005 240 x 250 x 50 mm
- 35-372-006 240 x 250 x 60 mm
- 35-373-007 480 x 250 x 50 mm
- 35-374-008 480 x 250 x 60 mm
- 35-375-009 480 x 250 x 70 mm
- 35-376-010 300 x 300 x 50 mm
- 35-377-011 350 x 350 x 60 mm
- 35-378-012 470 x 400 x 60 mm
- 35-379-013 480 x 480 x 50 mm
- 35-380-014 480 x 480 x 60 mm
- 35-381-015 500 x 300 x 50 mm
- 35-382-016 520 x 300 x 50 mm
- 35-383-017 520 x 300 x 60 mm
- 35-384-018 550 x 430 x 50 mm
- 35-385-019 600 x 300 x 60 mm

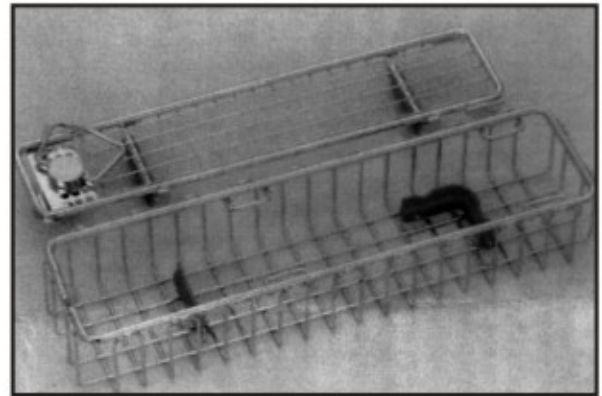

## ARTHROSCOPE BASKET

- 35-386-001 290 x 80 x 52 mm

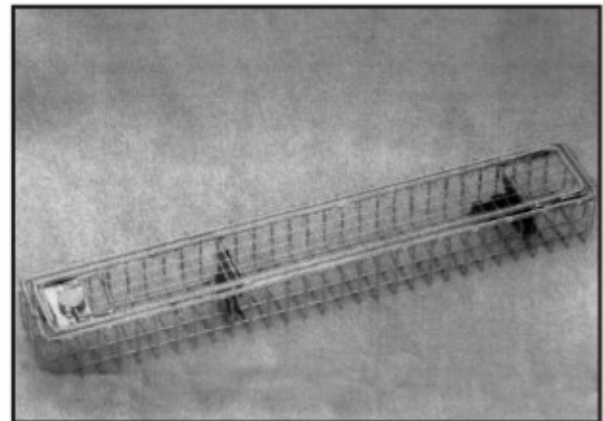

## ENDOSCOPE BASKET

- 35-387-001 460 x 80 x 52 mm
- 35-388-002 660 x 80 x 52 mm
- 35-389-003 670 x 80 x 52 mm





## STERILIZING FORCEPS



**DAVIS**  
35-390-160 16 cm, 6 1/4"  
35-391-200 20 cm, 8"  
35-392-240 24 cm, 9 1/2"

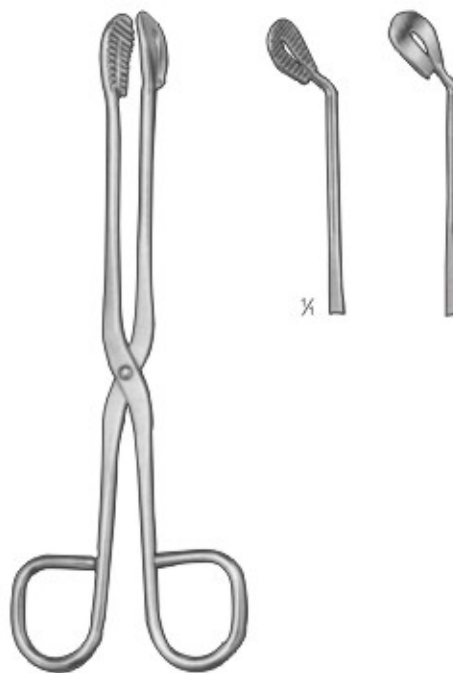

**UTILITY**  
35-393-200 20 cm, 8"  
35-394-280 28 cm, 11"

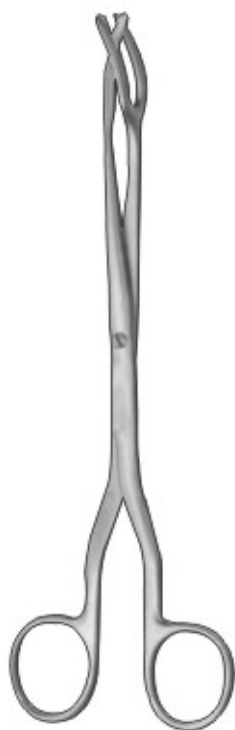

35-395-200 20 cm, 8"  
35-396-250 25 cm, 10"  
35-397-300 30 cm, 11 3/4"



**ROGGE**  
35-398-270  
27 cm, 11"



**CHEATEL**  
Box Joint  
35-399-270  
27 cm, 11"

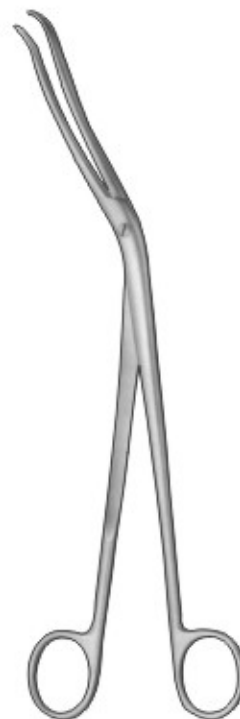

**CHEATEL**  
Screw Joint  
35-400-270  
27 cm, 11"



---

# ***SURGICAL INSTRUMENT SETS***

---



## SURGICAL INSTRUMENT SETS

### MAJOR BASIC SET

QTY .	DESCRIPTION	
2 each	MAYO DISSECTING SCISSORS, STRAIGHT.....	6 3/4"
1 each	MAYO DISSECTING SCISSORS, CURVED.....	5 1/2"
2 each	MAYO DISSECTING SCISSORS, CURVED.....	6 3/4"
12 each	HALSTED MOSQUITO FORCEPS, CURVED.....	5"
6 each	KELLY FORCEPS, STRAIGHT.....	5 1/2"
18 each	KELLY FORCEPS, CURVED.....	5 1/2"
18 each	ROCHESTER-PEN FORCEPS, CURVED.....	6 1/4"
6 each	ROCHESTER-PEN FORCEPS, CURVED.....	7 1/4"
12 each	ROCHESTER-OCHSNER FORCEPS, STRAIGHT.....	6 1/4"
2 each	DRESSING FORCEPS, SERRATED.....	5 1/2"
1 each	DRESSING FORCEPS, SERRATED.....	8"
2 each	TISSUE FORCEPS 1 X 2 TEETH.....	5 1/2"
1 each	TISSUE FORCEPS 1 X 2 TEETH.....	8"
2 each	CRILE-WOOD T.C. NEEDLE HOLDERS.....	6"
2 each	MAYO-HEGAR T.C.NEEDLE HOLDERS.....	7"
2 each	MAYO-HEGAR T.C.NEEDLE HOLDERS.....	8"
1 each	METZENBAUM SCISSORS, CURVED.....	5 3/4"
1 each	WIRE SCISSORS, ANGULAR.....	4 3/4"
1 each	DIRECTOR AND TONGUE TIE, PROBE END.....	6"
1 each	PROBE, W/ EYE.....	6"
1 each	OCHSNER TROCER, 20 FR	
1 each	POOLE SUCTION TUBE, ANGULAR, 23 FR	
1 each	POOLE SUCTION TUBE, STRAIGHT, 30 FR	
4 each	BABCOCK FORCEPS.....	6 1/4"
4 each	BABCOCK FORCEPS.....	7 3/4"
12 each	ALLIS FORCEPS, 4 X 5 TEETH.....	6"
4 each	ALLIS FORCEPS, 6 X 7 TEETH.....	7 1/2"
1 each	U.S. ARMY RETRACTOR, DOUBLE ENDED, SET OF 2	
1 each	PARKER RETRACTORS, D.E, SET OF 2.....	5/8" X 5"
2 each	KELLY RETRACTORS, MEDIUM	
6 each	RICHARSON RETRACTORS, MEDIUM	
1 each	RICHARSON-EASTMAN RETRACTOR, SMALL	
1 each	RICHARSON-EASTMAN RETRACTOR, LARGE	
1 each	DEAVER RETRACTOR.....	1" X 12"
1 each	DEAVER RETRACTOR.....	2" X 12"
2 each	DEAVER RETRACTOR.....	3" X 12"
2 each	MALLEABLE RETRACTOR.....	1 1/2" X 13"
2 each	VOLKMAN RETRACTOR, SHARP POINTS, 4 PROG	
1 each	BALFOUR RETRACTOR	
12 each	METZENBAUM SCISSORS, CURVED.....	7"
8 each	BACKHAUS TOWEL CLAMP.....	5 1/4"
1 each	SPONGE FORCEPS, STRAIGHT, SERRATED.....	9 1/2"
1 each	DEAVER RETRACTOR.....	1" X 9 12"
1 each	DEAVER RETRACTOR.....	1" X 13"
1 each	DEAVER RETRACTOR.....	1" X 14 1/2"
1 each	DEAVER RETRACTOR.....	1 1/2" X 12"



## MAJOR BASIC SET

QTY .	DESCRIPTION	
1 each	MAYO DISSECTING SCISSORS, STRAIGHT.....	5"
1 each	MAYO DISSECTING SCISSORS, CURVED.....	5 1/2"
12 each	HALSTED MOSQUITO FORCEPS, CURVED.....	5"
6 each	KELLY FORCEPS, STRAIGHT.....	5 1/2"
12 each	KELLY FORCEPS, CURVED.....	5 1/2"
6 each	ROCHESTER-OCHSNER FORCEPS, STRAIGHT.....	6 1/4"
1 each	DRESSING FORCEPS, SERRATED.....	4 1/2"
1 each	DRESSING FORCEPS, SERRATED.....	5 1/2"
1 each	TISSUE FORCEPS 1 X 2 TEETH.....	4 1/2"
1 each	TISSUE FORCEPS 1 X 2 TEETH.....	5 1/2"
2 each	CRILE-WOOD T.C. NEEDLE HOLDERS.....	6"
2 each	MAYO-HEGAR T.C.NEEDLE HOLDERS.....	7"
1 each	METZENBAUM SCISSORS, CURVED.....	5 3/4"

## INTESTINAL INSTRUMENT SET

USED WITH MAJOR BASIC SET

QTY .	DESCRIPTION	
1 each	DRESSING FORCEPS.....	10"
2 each	MAYO-HEGAR NEEDLE HOLDER.....	7"
1 each	PAYR PYLORUS CLAMP.....	5 3/4"
6 each	PERCY INTESTINAL FORCEPS.....	6"
6 each	BABCOCK INTESTINAL FORCEPS.....	7 3/4"
3 each	ALLIS TISSU FORCEPS, 5 X 6 TEETH.....	7 3/4"
2 each	PEAN G.I. FORCEPS, STRAIGHT.....	9"
2 each	PEAN G.I. FORCEPS, CURVED.....	9"
2 each	ALLEN INTESTINAL CLAMPS, STRAIGHT.....	8"
2 each	DOYEN FORCEPS, STRAIGHT.....	8 3/4"
2 each	DOYEN FORCEPS.CURVED.....	8 3/4"
1 each	PAYR PYLORUS CLAMP.....	8"
1 each	PAYR PYLORUS CLAMP.....	11"
1 each	PAYR PYLORUS CLAMP.....	13 3/4"
1 each	DEAVER RETRACTOR.....	2"+12"
2 each	SPONGE FORCEPS, STRAIGHT, SERRATED.....	9 1/2"

## CAESAREAN SECTION SET

USED WITH MAJOR BASIC SET

QTY .	DESCRIPTION	
1 each	BANDAGE SCISSORS.....	7 1/4"
8 each	PENNINGTON CLAMPS, STRAIGHT.....	5 3/4"
1 each	DELEE O.B. FORCEPS,SHORT.....	12"



# SURGICAL INSTRUMENT SETS

## GALL BLADDER SET

QTY .	DESCRIPTION	USED WITH MAJOR BASIC SET
2 each	CRILE- WOOD NEEDLE HOLDER.....	7"
1 each	MAYO CYSTIC DUCT SCOOP	
1 each	MAYO COMMON DUCT SCOOP, SMALL	
1 each	MAYO COMMON DUCT SCOOP, MEDIUM	
1 each	MAYO COMMON DUCT SCOOP, LARGE	
4 each	BAKES COMMON DUCT DILATORS, 3MM-11 MM, SET OF 9	
4 each	JOHNS HOPKINS GALL BLADDER FORCEPS.....	8"
6 each	LAHEY GALL DUCT FORCEPS.....	7 1/2"
1 each	LAHEY GALL DUCT FORCEPS.....	9"
1 each	GREY CYSTIC DUCT FORCEPS, WITHOUT TEETH, SET OF 2	
1 each	GREY-CYSTIC DUCT FORCEPS, WITH TEETH, SET OF 2	
1 each	BLAKE GALL STONE FORCEPS. CURVED.....	8"
1 each	DESJARDIN GALL STONE FORCEPS.....	9 1/2"
1 each	OCHSNER TROCER. SIZE 16 (FOR 12 FR. CATHETER)	
1 each	OCHSNER TROCER.SIZE 20 (FOR 16 FR. CATHETER)	
1 each	OCHSNER TROCER, SIZE 22 (FOR 18 FR. CATHETER)	
1 each	POOLE SUCTION TUBE. ANGULAR, 23 FR.	
3 each	ALLIS FORCEPS, 5*6 TEETH.....	7 3/4"
8 each	PEAN FORCEPS, CURVED.....	9"
1 each	NELSON-METZENBAUM SCISSORS, CURVED.....	9"
2 each	SPONGE FORCEPS. STRAIGHT. SERRATED.....	9 1/2"
4 each	PEANUT SPONGE FORCEPS, STRAIGHT, SERRATED.....	9 1/2"

## THYROIDECTOMY SET

QTY .	DESCRIPTION	
24 each	PROVIDENCE HOSPITAL FORCEPS, STRAIGHT.....	5 1/2"
24 each	PROVIDENCE HOSPITAL FORCEPS, CURVED.....	5 1/2"
6 each	LAHEY GOITER FORCEPS.....	6 1/4"
4 each	MASTIN MUSCLE CLAMPS.....	6 3/4"
2 each	LAHEY RETRACTOR.....	7 3/4"
1 each	GREEN RETRACTOR.....	8 1/2"

## VAGOTOMY SET

QTY .	DESCRIPTION	
2 each	DRESSING FORCEPS, SERRATED.....	12"
2 each	MASSON NEEDLE HOLDERS. T.C JAW.....	10 1/2"
2 each	LOWER GALL DUCT FORCEPS.....	7"
2 each	LAHEY GALL DUCT FORCEPS.....	7 1/2"
6 each	ALLIS FORCEPS, 5*6 TEETH.....	6"
1 each	MAYO DISSECTING SCISSORS. CURVED.....	9"
1 each	NELSON-MEZTENBAUM THORACIC SCISSORS. CVD.....	9"
1 each	NELSON-MEZTENBAUM THORACIC SCISSORS. STR.....	9"
1 each	PARKER-MOTT RETRACTORS. DOUBLE ENDED, SET OF 2	
2 each	DEAVER RETRACTOR.....	2"* 12"
2 each	GREEN RETRACTOR.....	8 1/2"
2 each	SPONGE FORCEPS. STRAIGHT. SERRATED.....	9 1/2"



## NEUROSURGICAL LAMINECTOMY INSTRUMENTS

QTY.	DESCRIPTION	
1 each	CUSHING BRAIN FORCEPS, SERRATED .....	7"
1 each	CUSHING BRAIN FORCEPS. W/MOUSE TEETH.....	7"
2 each	ADSON BRAIN FORCEPS, W/MOUSE TEETH.....	4 3/4"
2 each	ADSON BRAIN FORCEPS, SERRATED.....	4 3/4"
1 each	ADSON FORCEPS. BAYONET. SERRATED.....	7 1/2"
1 each	SMITHWICK CLIP APPLYING FORCEPS.....	10 1/2"
1 each	SWEET CLIP APPLYING FORCEPS.....	9 1/4"
1 each	SWEET CLIP APPLYING FORCEPS.....	11"
1 each	STRULLY SCISSORS, CURVED.....	8 3/4"
2 each	SENN RETRACTORS, DOUBLE ENDED. SHARP.....	6 1/4"
10 each	BACKHAUS TOWEL CLAMP.....	5 1/2"
8 each	SPONGE FORCEPS, STRAIGHT, SERRATED.....	9 1/2"
1 each	YABKAUER SUCTION TUBE	
2 each	OPERATING SCISSORS, STRAIGHT, SHARP/BLUNT.....	5 1/2"
2 each	MAYO DISSECTING SCISSORS, STRAIGHT.....	5 1/2"
2 each	MAYO DISSECTING SCISSORS, STRAIGHT.....	6 3/4"
2 each	MAYO DISSECTING SCISSORS, CURVED.....	5 1/2"
2 each	MAYO DISSECTING SCISSORS, CURVED.....	6 3/4"
24 each	CRILE FORCEPS, CURVED.....	5 1/2"
2 each	CRILE-WOOD NEEDLE HOLDERS, T.C. JAW.....	6"
1 each	SUTURE WIRE CUTTING SCISSORS, ANGULAR	
1 each	GROOVED DIRECTOR.....	6"
2 each	PROBES, W/EYE, SILVER.....	6"
12 each	ALLIS FORCEPS. 5X6 TEETH.....	7 3/4"
1 each	STILLE-LISTON BONE FORCEPS, STRAIGHT.....	10 1/2"
1 each	STILLE-LUER BONE RONGEUR, CURVED.....	8 1/2"
1 each	STILLE-LUER BONE RONGEUR, ANGULAR.....	9"
1 each	GERZOG BONE Mallet	
1 each	ARMY PATTERN OSTEOTOME,6mm	
1 each	ARMY PATTERN OSTEOTOME,12mm	
1 each	ARMY PATTERN OSTEOTOME,18mm	
1 each	LANGENBECK ELEVATOR, NARROW.....	7 1/2"
1 each	LANGENBECK ELEVATOR, BROAD.....	7 1/2"
1 each	SAYRE ELEVATOR, BLUNT, DOUBLE ENDED	
1 each	CUSHING DECOMPRESSION RETRACTOR.....	8"
1 each	CUSHING NERVE AND VEIN RETRACTOR.....	9"
1 each	WEITLANER RETRACTOR, SHARP.....	6 1/2"
24 each	DANDY SCALP HEMOSTATS.....	5 1/2"
6 each	ADSON FORCEPS, STRAIGHT.....	7 1/4"
6 each	ADSON FORCEPS, CURVED.....	7 1/4"
1 each	ADSON DURA HOOK, SHARP	
1 each	FRAZIER BRAIN SUCTION TUBE, 6FR.	
4 each	GIGLI SAW, STILLE PATTERN.....	20"
1 each	HANDLES, SOLID, FOR GIGLI SAWS, IN PAIRS	



## SURGICAL INSTRUMENT SETS

### CARDIAC ARREST SET

QTY .	DESCRIPTION	
1 each	MAYO DISSECTING SCISSORS, STRAIGHT.....	6 3/4"
1 each	MAYO DISSECTING SCISSORS, CURVED.....	6 3/4"
6 each	HALSTEAD MOSQUITO FORCEPS, STRAIGHT.....	5"
6 each	ROCHESTER-PEAN FORCEPS, CURVED.....	6 1/4"
1 each	DRESSING FORCEPS.....	6"
1 each	TISSUE FORCEPS, 1x2 TEETH.....	4 1/2"
1 each	MAYO-HEGER NEEDLE HOLDER, T.C. JAW.....	7"
2 each	ALLIS INTESTINAL FORCEPS, 4x5 TEETH.....	6"
4 each	BACKHAUS TOWEL CLAMP.....	5 1/2"
2 each	SPONGE FORCEPS, STRAIGHT, SERRATED.....	9 1/2"

### THORACIC AND CARDIOVASCULAR INSTRUMENTS

QTY .	DESCRIPTION	
2 each	YANKAUER SUCTION TUBES.....	6 3/4"
2 each	MAYO DISSECTING SCISSORS, STRAIGHT.....	6 3/4"
2 each	MAYO DISSECTING SCISSORS, CURVED.....	5"
36 each	HALSTEAD MOSQUITO FORCEPS, STRAIGHT.....	5"
36 each	HALSTEAD MOSQUITO FORCEPS, CURVED.....	6 1/4"
36 each	ROCHESTER-PEAN FORCEPS, CURVED.....	6 1/4"
18 each	ROCHESTER-OCHSNER FORCEPS, STRAIGHT.....	8"
12 each	ROCHESTER-OCHSNER FORCEPS, STRAIGHT.....	5 1/2"
36 each	CRILE FORCEPS, CURVED.....	5 1/2"
2 each	DRESSING FORCEPS, SERRATED.....	8"
2 each	DRESSING FORCEPS, SERRATED.....	10"
2 each	DRESSING FORCEPS, SERRATED.....	5 1/2"
2 each	TISSUE FORCEPS 1x2 TEETH.....	6"
1 each	RUSSIAN TISSUE FORCEPS.....	8"
2 each	RUSSIAN TISSUE FORCEPS.....	7"
2 each	CRILE-WOOD NEEDLE HOLDER.....	7"
2 each	MAYO-HEGAR NEEDLE HOLDER.....	8"
1 each	HEGAR NEEDLE HOLDER, T.C. JAW.....	10 1/2"
2 each	MASSON NEEDLE HOLDER, T.C. JAW.....	
1 each	SUTURE WIRE CUTTING SCISSORS, ANGULAR.....	6"
2 each	GROOVED DIRECTOR.....	6"
2 each	PROBES W/EYE, SILVER.....	
1 each	OCHSNER TROCAR, SIZE 20.....	6 1/4"
6 each	BABCOCK FORCEPS.....	7 3/4"
10 each	BABCOCK FORCEPS.....	9 1/4"
2 each	BABCOCK FORCEPS.....	6"
12 each	ALLIS FORCEPS, 5x6 TEETH.....	10"
10 each	ALLIS FORCEPS, 5x6 TEETH.....	9"
6 each	PEAN FORCEPS, STRAIGHT.....	10 1/2"
1 each	STILLE-LISTON BONE FORCEPS, CURVED.....	10 1/2"
1 each	STILLE-HORSLEY BONE FORCEPS, BAYONET.....	8 1/2"
1 each	STILLE-LUER BONE RONGEUR, CURVED.....	7 1/2"
1 each	POTTS-SMITH SCISSORS, 45 DEGREE ANGLE.....	7 1/4"
1 each	POTTS-SMITH SCISSORS, 60 DEGREE ANGLE.....	9 1/2"
2 each	POTTS-SMITH DRESSING FORCEPS, SERRATED.....	7"
1 each	POTTS-SMITH TISSUE FORCEPS, 1x2 TEETH.....	14"
1 each	BETHUNE RIB SHEARS.....	8 1/2"
1 each	STILLE RIB SHEARS.....	10"
1 each	LEBSCHKE STERNUM KNIFE.....	1 1/2"
2 each	MIXTER CLAMPS, CURVED.....	



## THORACIC AND CARDIOVASCULAR INSTRUMENTS

QTY .	DESCRIPTION	
6 each	DUVAL LUNG GRASPING FORCEPS, 1" JAW.....	8"
1 each	MATSON RIB STRIPPER.....	8 3/4"
1 each	ALEXANDER COSTAL PERIOSTEOTOME.....	8 1/2"
1 each	DOYEN RIB RASPATORY AND ELEVATOR, RIGHT.....	6"
1 each	DOYEN RIB RASPATORY AND ELEVATOR, LEFT.....	6"
1 each	HARRINGTON SPLANCHNIC RETRACTOR, LARGE.....	12 1/2"
2 each	HIBBS RETRACTOR, BLADE.....	3" x 1"
1 each	DEAVER RETRACTOR.....	1" x 12"
1 each	DEAVER RETRACTOR.....	1" x 13"
2 each	DEAVER RETRACTOR.....	1 1/2" x 12"
2 each	RIBBON MALLEABLE RETRACTOR.....	1 1/2" x 13"
2 each	VOLKMAN RAKE RETRACTOR, 4 SPONG SHARP	
18 each	BACKHAUS TOWEL CLAMP.....	5 1/2"
18 each	SPONGE FORCEPS, SERRATED, STRAIGHT.....	9 1/2"
2 each	DEAVER RETRACTOR.....	2" x 12"
2 each	NELSON-MEZTENBAUM SCISSORS, CURVED.....	9"
2 each	NELSON-MEZTENBAUM SCISSORS, CURVED.....	11"
2 each	GREEN RETRACTOR.....	8 1/2"
1 each	PARKER RETRACTORS, SET OF 2.....	5" x 3/4"
2 each	LANGENBECK RETRACTOR.....	3/8" x 1 1/2"
2 each	DEAVER RETRACTOR, 1" BLADE.....	9 1/2"
1 each	ADSON FORCEPS, MOUSE TEETH.....	4 3/4"
1 each	ADSON FORCEPS, SERRATED.....	4 3/4"
1 each	SATINSKY VENA CAVA CLAMP.....	10 1/4"
1 each	POTTS-SMITH SCISSORS, 25 DEGREE ANGLE.....	7 1/2"
<b>TONSIL INSTRUMENT SET</b>		
QTY.	DESCRIPTION	
1 each	YANKAUER SUCTION TUBE	
1 each	MAYO-HEGAR NEEDLE HOLDER, T.C. JAW.....	6"
1 each	LAFORCE ADENOTOME, LARGE	
1 each	LAFORCE ADENOTOME, MEDIUM	
1 each	LAFORCE ADENOTOME, SMALL	
3 each	BLADES FOR LAFORCE ADENOTOME, LARGE	
3 each	BLADES FOR LAFORCE ADENOTOME, MEDIUM	
3 each	BLADES FOR LAFORCE ADENOTOME, SMALL	
1 each	BARNHILL ADENOID CURETTE, SIZE 1	
1 each	BARNHILL ADENOID CURETTE, SIZE 2	
2 each	LARYNGEAL MIRRORS, W/HANDLE, SIZE 4	
1 each	DENHARDT MOUTH GAG	
1 each	JENNINGS MOUTH GAG, LARGE	
1 each	JENNINGS MOUTH GAG, SMALL	
1 each	WIEDER TONGUE DEPRESSOR, SMALL	
3 each	FOERSTER SPONGE FORCEPS, SERRATED, CVD.....	7"
1 each	WHITE TONSIL FORCEPS, CURVED.....	9"
2 each	SCHNIDT TONSIL FORCEPS, HALF CURVED JAW.....	7 1/2"
1 each	BOETTCHER TONSIL SCISSORS, CURVED.....	7"
1 each	METZENBAUM SCISSORS, CURVED.....	7"
1 each	HURD DISSECTOR AND RETRACTOR	
1 each	ABRAHAM DOUBLE EDGED TONSIL KINFE.....	8"
1 each	FISHER TONSIL KNIFE, SERRATED EDGE.....	9"
1 each	BECK- SCHENCK TONSIL SNARE, COMPLETE	
1 each	TYDING TONSIL SNARE, COMPLETE	
2 each	BACKHAUS TOWEL CLAMP.....	5 1/4"





## SURGICAL INSTRUMENT SETS

### TRACHEOTOMY SET

QTY.	DESCRIPTION	
1 each	OPERATING SCISSORS, STRAIGHT, S/B.....	5 1/2"
1 each	MAYO DISSECTING SCISSORS, CURVED.....	5 1/2"
6 each	HALSTEAD MOSQUITO FORCEPS, CURVED.....	5"
2 each	ROCHESTER-PEAN FORCEPS, CURVED.....	5 1/2"
10 each	CRILE FORCEPS, STRAIGHT.....	5 1/2"
2 each	DRESSING FORCEPS, SERRATED.....	5"
2 each	TISSUE FORCEPS, 2 x 3 TEETH.....	5 1/2"
1 each	CRILE-WOOD T.C. JAW NEEDLE HOLDER.....	6"
2 each	ALLIS FORCEPS, 4 x 5 TEETH.....	6"
1 each	METZENBAUM SCISSORS, CURVED.....	7"
1 each	TRACHEAL RETR. SHARP, 1 PRONG	
1 each	LABORDE DILATOR, TRI-VALVE	
4 each	BACKHAUS TOWEL CLAMP.....	5 1/2"
4 each	SPONGE FORCEPS, STRAIGHT, SERRATED.....	9 1/2"

### OBSTETRICAL FORCEPS

QTY .	DESCRIPTION	
2 each	DELEE FORCEPS, STANDARD.....	14"
1 each	SIMPSON FORCEPS, SHORT.....	12"
1 each	SIMPSON FORCEPS, LONG.....	14"
2 each	KIELAND LUIKART FORCEPS.....	15 3/4"
2 each	SIMPSON LUIKART FORCEPS.....	14"
1 each	PIPER FORCEPS.....	17 1/2"

### OBSTETRICAL INSTRUMENTS

QTY.	DESCRIPTION	
2 each	OPERATING SCISSORS, STRAIGHT, BLUNT/BLUNT.....	15 1/2"
6 each	MAYO SCISSORS, STRAIGHT.....	6 3/4"
6 each	MAYO SCISSORS, CURVED.....	6 3/4"
12 each	HALSTEAD MOSQUITO FORCEPS, STRAIGHT	
1 each	HALSTEAD MOSQUITO FORCEPS, CURVED	
12 each	KELLY FORCEPS, STRAIGHT	
12 each	KELLY FORCEPS, CURVED	
12 each	ROCHESTER-PEAN FORCEPS, STRAIGHT.....	6 1/4"
12 each	DRESSING FORCEPS.....	6"
12 each	TISSUE FORCEPS, 2 x 3 TEETH.....	6"
4 each	MAYO-HEGAR NEEDLE HOLDERS, T.C. JAW.....	7"
4 each	MAYO-HEGAR NEEDLE HOLDERS, T.C. JAW.....	7"
2 each	PROBE W/EYE, SILVER.....	6"
12 each	ALLIS TISSUE FORCEPS, 5 x 6 TEETH.....	6"
24 each	BACKHAUS TOWEL CLAMP.....	5 1/4"
24 each	SPONGE FORCEPS, STRAIGHT, SERRATED.....	9 1/2"
2 each	MAYO SCISSORS, CURVE.....	9"
2 each	JACKSON VAGINAL RETRACTORS, MEDIUM	
2 each	JACKSON VAGINAL RETRACTORS, SMALL	
1 each	AUVARD WEIGHTED SPECULUM, MEDIUM	
2 each	GELPI RETRACTOR.....	7"
2 each	GRAVES VAGINAL SPECULUM, SMALL	



## OBSTETRICAL INSTRUMENTS

QTY.	DESCRIPTION
3 each	GRAVES VAGINAL SPECULUM, MEDIUM
2 each	GRAVES VAGINAL SPECULUM, LARGE
1 each	PEDERSON VAGINAL SPECULUM, NARROW
4 each	BOZEMAN UTERINE DRESSING FORCEPS, STR..... 10"
2 each	SCHROEDER UTERINE TENACULUM
2 each	IOWA MEMBRANE PUNCTURING FORCEPS
1 each	COLLYER PELVIMETER

### DILATON AND CURETTAGE SET

QTY .	DESCRIPTION
1 each	OPERATING SCISSORS, STR., SHARP/BLUNT..... 5 1/2"
6 each	BACKHAUS TOWEL CLAMP..... 5 1/2"
4 each	SPONGE FORCEPS., SERRATED..... 9 1/2"
1 each	JACKSON RETRACTOR, LARGE BLADE..... 4" x 1 1/2"
1 each	JACKSON RETRACTOR, MEDIUM BLADE..... 3 1/2" x 1 1/2"
1 each	JACKSON RETRACTOR SMALL, BLADE..... .3" x 1 1/2"
1 each	SIMS RETRACTOR, DOUBLE ENDED, NO. 4
1 each	SIMS RETRACTOR, DOUBLE ENDED, NO. 6
1 each	AUVARD WEIGHTED SPECULUM, MEDIUM
1 each	GRAVES SPECULUM, MEDIUM
1 each	GOODELL UTERINE DILATOR, LARGE..... 13"
1 each	GOODELL UTERINE DILATOR, SMALL..... 11"
1 each	HEGAR DILATORS, SET OF 8
1 each	SIMS SOUND, PLAIN
1 each	SIMPSON SOUND, GRADUATED
1 each	SIMS CURETTE, SIZE 1, SHARP
1 each	SIMS CURETTE, SIZE 2
1 each	SIMS CURETTE, SIZE 3
1 each	SIMS CURETTE, SIZE 4
1 each	SIMS CURETTE, SIZE 5
1 each	SIMS CURETTE, SIZE 6
1 each	THOMAS UTERINE CURETTE, SIZE 1, BLUNT
1 each	THOMAS UTERINE CURETTE, SIZE 2
1 each	THOMAS UTERINE CURETTE, SIZE 3
1 each	THOMAS UTERINE CURETTE, SIZE 4
1 each	THOMAS UTERINE CURETTE, SIZE 5
1 each	THOMAS UTERINE CURETTE, SIZE 6
1 each	THOMS-GAYLOR BIOPSY FORCEPS, IMPROVED JAW..... 8 1/2"
1 each	BOZEMAN UTERINE DRESSING FORCEPS, CVD..... 10"
2 each	SCHROEDER TENACULUM..... 9"

### MISCELLANEOUS INSTRUMENTS

QTY .	DESCRIPTION
1 each	FINGER RING CUTTER
1 each	FINGER NAIL DRILL W/THREE DRILLS
6 each	YANKAUER SUCTION TUBES



## SURGICAL INSTRUMENT SETS

### MISCELLANEOUS INSTRUMENTS

QTY .	DESCRIPTION	
6 each	STERILIZER UTILITY FORCEPS, STRAIGHT.....	11"
12 each	LISTER BANDAGE SCISSORS.....	5 1/2"
6 each	LISTER BANDAGE SCISSORS.....	7 1/4"
6 each	OPERATING SCISSORS, STR., SHARP/SHARP.....	5 1/2"
12 each	OPERATING SCISSORS, STR., SHARP/BLUNT.....	5 1/2"
6 each	OPERATING SCISSORS, STR., BLUNT/BLUNT.....	5 1/2"
6 each	OPERATING SCISSORS, STR., SHARP/BLUNT.....	6 1/2"
6 each	MAYO DISSECTING SCISSORS, STRAIGHT.....	5 1/2"
12 each	MAYO DISSECTING SCISSORS, STRAIGHT.....	6 3/4"
12 each	MAYO DISSECTING SCISSORS, CURVED.....	5 1/2"
12 each	MAYO DISSECTING SCISSORS, CURVED.....	6 3/4"
24 each	HALSTEAD MOSQUITO FORCEPS, STRAIGHT.....	5"
48 each	HALSTEAD MOSQUITO FORCEPS, CURVED.....	5"
24 each	ROCHESTER-PEAN FORCEPS, CURVED.....	7 1/4"
24 each	CRILE FORCEPS, STRAIGHT.....	5 1/2"
12 each	CRILE FORCEPS, CURVED.....	5 1/2"
1 each	DRESSING FORCEPS, SERRATED.....	5 1/2"
12 each	VIRTUS SPLINTER FORCEPS.....	6"
12 each	BAUMGARTNER NEEDLE HOLDERS, T.C. JAW.....	5 1/2"
6 each	MAYO-HEGAR NEEDLE HOLDER, T.C. JAW.....	6"
6 each	MAYO-HEGAR NEEDLE HOLDER, T.C. JAW.....	7"
12 each	MAYO-HEGAR NEEDLE HOLDER, T.C. JAW.....	8"
12 each	METZENBAUM SCISSORS, CURVED.....	5 3/4"
12 each	ADSON FORCEPS, SERRATED.....	4 3/4"
2 each	MALLEABLE RETRACTOR.....	1" X 13"
4 each	MALLEABLE RETRACTOR.....	1 3/4" x 13"
2 each	MALLEABLE RETRACTOR.....	2" x 13"
2 each	VOLKMAN RETRACTOR, BLUNT, 2 PRONG	
2 each	VOLKMAN RETRACTOR, BLUNT, 4 PRONG	
2 each	VOLKMAN RETRACTOR, BLUNT, 6 PRONG	
6 each	STRABISMUS SCISSORS, STRAIGHT.....	4 1/4"
6 each	STRABISMUS SCISSORS, CURVED.....	4 1/4"
6 each	IRIS SCISSORS, CURVED.....	4 1/2"
6 each	IRIS SCISSORS, STRAIGHT.....	4 1/2"
1 each	COAKLEY CURETTE, SET OF 6	
1 set	VAN BUREN SOUNDS, SET OF 12, SIZES 8-30 FR.	
1 each	JONES TOWEL CLAMP, CROSS ACTION.....	3"
12 each	SPONGE FORCEPS, STRAIGHT, SERRATED.....	9 1/2"
12 each	SPONGE FORCEPS, STRAIGHT, SERRATED.....	7"
6 each	GRAVES SPECULUM, SMALL	
1 each	GRAVES SPECULUM, MEDIUM	
6 each	GRAVES SPECULUM, LARGE	
6 each	SUTURE WIRE CUTTING SCISSORS, ANGULAR	
2 each	OCHSNER GALL BLADDER TROCAR, 14 FR.	
2 each	OCHSNER GALL BLADDER TROCAR, 20 FR.	
2 each	OCHSNER GALL BLADDER TROCAR, 24 FR.	
24 each	BACKHAUS TOWEL CLAMP.....	3 1/2"
36 each	BACKHAUS TOWEL CLAMP.....	5 1/2"
12 each	ADSON FORCEPS, MOUSE TEETH.....	4 3/4"
2 each	PEDERSON SPECULUM, SMALL.....	3 1/2" x 7 1/2"
6 each	BOZEMAN UTERINE DRESSING FORCEPS, CVD.....	10"



## PELVIC SET

QTY.	DESCRIPTION
<b>USED WITH MAJOR BASIC SET</b>	
1 each	MAYO DISSECTING SCISSORS, STRAIGHT..... 6 3/4"
1 each	MAYO DISSECTING SCISSORS, CURVED..... 6 3/4"
12 each	KELLY FORCEPS, CURVED..... 5 1/2"
10 each	OCHSNER FORCEPS, CURVED..... 8"
6 each	OCHSNER FORCEPS, STRAIGHT..... 6 1/4"
6 each	OCHSNER FORCEPS, STRAIGHT..... 8"
1 each	DRESSING FORCEPS..... 6"
1 each	TISSUE FORCEPS, 1 x 2 TEETH..... 6"
2 each	MASSON NEEDLE HOLDER, T.C. JAW..... 10 1/2"
6 each	PEAN FORCEPS, CURVED..... 9"
6 each	PEAN FORCEPS, CURVED..... 10"
4 each	BACKHAUS TOWEL CLAMP..... 5 1/2"
2 each	SPONGE FORCEPS, STRAIGHT, SERRATED..... 9 1/2"
6 each	HEANEY-BALLANTINE HYSTERECTOMY FORCEPS, CVD..... 8"
2 each	HEANEY NEEDLE HOLDERS, T.C. JAWS..... 8 1/4"
1 each	SCHROEDER TENACULUM..... 9"
1 each	SCHROEDER VULSELLUM FORCEPS, STRAIGHT..... 9"

## PLASTIC SET

QTY .	DESCRIPTION
1 each	MAYO DISSECTING SCISSORS, STRAIGHT..... 5 1/2"
1 each	MAYO DISSECTING SCISSORS, CURVED..... 5 1/2"
6 each	HALSTEAD MOSQUITO FORCEPS, STRAIGHT..... 5"
12 each	HALSTEAD MOSQUITO FORCEPS, CURVED..... 5"
4 each	ROCHESTER-OCHSNER FORCEPS, STRAIGHT..... 5 1/2"
2 each	CRILE-WOOD NEEDLE HOLDER..... 6"
2 each	BAUMGARTNER NEEDLE HOLDERS..... 5"
4 each	ALLIS FORCEPS, 4 x 5 TEETH..... 6"
4 each	SENN RETRACTOR, SHARP
1 each	STEVENS TEOTOMOY SCISSORS, CVD., BLUNT
1 each	STEVENS TEOTOMOY SCISSORS, STR., BLUNT
1 each	VIENNA NASAL SPECULUM, ADULT
6 each	BACKHAUS TOWEL CLAMP..... 3 1/2"

## BASIC ORTHOPEDIC SET

QTY.	DESCRIPTION
2 each	MAYO DISSECTING SCISSORS, STRAIGHT..... 5 1/2"
1 each	MAYO DISSECTING SCISSORS, STRAIGHT..... 6 3/4"
2 each	MAYO DISSECTING SCISSORS, CURVED..... 5 1/2"
1 each	MAYO DISSECTING SCISSORS, CURVED..... 6 3/4"
12 each	ROCHESTER-PEAN FORCEPS, CURVED..... 6 1/4"
10 each	ROCHESTER-OCHSNER FORCEPS, STRAIGHT..... 6 1/4"
18 each	CRILE FORCEPS, CURVED..... 5 1/2"



## SURGICAL INSTRUMENT SETS

### BASIC ORTHOPEDIC SET

QTY .	DESCRIPTION	
2 each	DRESSING FORCEPS, SERRATED.....	5 1/2"
2 each	TISSUE FORCEPS, 1 x 2 TEETH.....	5 1/2"
1 each	CRILE-WOOD NEEDLE HOLDER, T.C. JAW.....	6"
2 each	MAYO-HEAGAR NEEDLE HOLDER, T.C. JAW.....	7"
1 each	SUTURE WIRE CUTTING SCISSORS, ANGULAR.....	4 3/4"
1 each	GROOVED DIRECTOR.....	6"
2 each	PROBES, W/EYE, SILVER.....	6"
10 each	ALLIS FORCEPS, 5 x 6 TEETH.....	6"
1 each	LANE SCREW DRIVER	
1 each	VAN BUREN SEQUESTRUM FORCEPS, BAYONET.....	8 1/2"
1 each	LANE BONE HOLDING FORCEPS, W/RATCHET.....	13"
1 each	KERN BONE HOLDING FORCEPS, W/RATCHET.....	8 1/2"
1 each	LAMBOTTE BONE FORCEPS.....	8 3/4"
1 each	LOWMAN CLAMP, LARGE	
1 each	LOWMAN CLAMP, LARGE	
1 each	LISTON BONE CUTTING FORCEPS, STRAIGHT.....	7 3/4"
1 each	STILLE-LISTON BONE FORCEPS, STRAIGHT.....	10 1/2"
1 each	STILLE-LISTON BONE FORCEPS, CURVED.....	10 1/2"
1 each	STILLE-LUER BONE RONGEUR, STRAIGHT.....	8 1/2"
1 each	STILLE-LUER BONE RONGEUR, ANGULAR.....	9"
2 each	GIGLI BONE SAWS, STILLE PATTERN.....	12"
2 each	GIGLI BONE SAWS, STILLE PATTERN.....	20"
2 each	GIGLI BONE SAWS, STILLE PATTERN.....	30"
1 pair	HANDLES FOR GIGLI SAW, SOLID	
1 each	SAYRE ELEVATOR, SHARP DOUBLE ENDED.....	6 1/2"
1 each	MURPHY BONE SKID, DOUBLE ENDED.....	12"
1 each	BONE FILE.....	9 1/2"
2 each	HIBBS RETRACTOR, BLADE 3" x 1" LENGTH.....	9 1/4"
2 each	GREEN RETRACTOR.....	8 1/2"
1 each	MAYO-COLLINS RETRACTOR, SET OF 2	
1 each	PARKER RETRACTOR, SET OF 2	
2 each	LANGENBECK RETRACTOR, MEDIUM	
2 each	VOLKMAN RETRACTOR, BLUNT, 4 PRONG.....	8 1/2"
1 each	LUCAE BAYONET FORCEPS.....	5 1/2"
1 each	METZENBAUM SCISSORS, CURVED.....	7"
10 each	BACKHAUS TOWER CLAMP.....	5 1/2"
8 each	SPONGE FORCEPS, STR., SERRATED.....	9 1/2"
1 each	VOLKMAN BONE CURETTES, OVAL, # 000.....	6 3/4"
1 each	VOLKMAN BONE CURETTES, OVAL, # 00.....	6 3/4"
1 each	VOLKMAN BONE CURETTES, OVAL, # 0.....	6 3/4"
1 each	VOLKMAN BONE CURETTES, OVAL, # 1.....	6 3/4"
1 each	VOLKMAN BONE CURETTES, OVAL, # 2.....	6 3/4"
1 each	VOLKMAN BONE CURETTES, OVAL, # 3.....	6 3/4"
1 each	VOLKMAN BONE CURETTES, OVAL, # 4.....	6 3/4"
1 each	VOLKMAN BONE CURETTES, OVAL, # 5.....	6 3/4"
1 each	VOLKMAN BONE CURETTES, OVAL, # 6.....	6 3/4"



## POST MORTEM INSTRUMENTS

QTY.	DESCRIPTION	
1 each	STERILIZER UTILITY FORCEPS, STRAIGHT.....	11"
1 each	OPERATING SCISSORS, STRAIGHT, S/S.....	5"
1 each	MAYO DISSECTING SCISSORS, STRAIGHT.....	6 3/4"
1 each	MAYO DISSECTING SCISSORS, CURVED.....	6 3/4"
1 each	DRESSING FORCEPS, SERRATED.....	6"
1 each	TISSUE FORCEPS, 1 x 2 TEETH.....	6"
1 each	TISSUE FORCEPS, 1 x 2 TEETH.....	10"
1 each	PROBE, W/EYE.....	10"
1 each	LANGENEACK METACARPAL SAW.....	4 1/2"
1 each	GLUCK RIB SHEARS.....	8 3/4"
1 each	MAYO DISSECTING SCISSORS, STRAIGHT.....	9"
1 each	CARTILAGE KNIFE, BLADE.....	6 1/2"
1 each	VIRCHOW KNIFE, BLADE.....	3 1/2"
1 each	SUTURE WIRE SCISSORS, ANGULAR.....	4 3/4"
1 each	DIRECTOR AND TONGUE TIE.....	6"
8 each	ALLIS FORCEPS, 4 x 5 TEETH.....	6"
2 each	GREEN RETRACTOR.....	8 1/2"
1 each	PARKER RETRACTOR, D.E., SET OF 2.....	7 1/8" x 7"
2 each	RICHARDSON RETRACTOR, SMALL.....	
2 each	VOLKMAN RETRACTORS, SHARP, 4 PRONG.....	
2 each	SENN D.E., RETRACTOR.....	6 1/4"
1 each	ALM RETRACTOR.....	2 3/4"
1 each	METZENBAUM SCISSORS, CURVED.....	5 3/4"
12 each	BACKHAUS TOWEL CLAMP.....	5 1/4"
8 each	SPONGE FORCEPS, STRAIGHT SERRATED.....	9 1/2"

## NEPHRECTOMY SET

QTY .	DESCRIPTION	
USED WITH MAJOR BASIC SET		
8 each	ROCHESTER-PEAN FORCEPS, CURVED.....	8"
8 each	ROCHESTER-OCHSNER FORCEPS, STRAIGHT.....	8"
2 each	DRESSING FORCEPS, SERRATED.....	10"
2 each	MASSON NEEDLE HOLDER, T.C. JAW.....	10 1/2"
2 each	LOWER GALL DUCT FORCEPS.....	7"
1 set	GREY CYSTIC DUCT FORCEPS, W/O TEETH, SET OF 2.....	
1 each	BLAKE GALL STONE FORCEPS, CURVED.....	8 1/4"
1 each	DESJARDIN GALL STONE FORCEPS.....	9 1/4"
1 each	RANDALL KIDNEY STONE FORCEPS, NO.1.....	
1 each	RANDALL KIDNEY STONE FORCEPS, NO.2.....	
1 each	RANDALL KIDNEY STONE FORCEPS, NO.3.....	
1 each	RANDALL KIDNEY STONE FORCEPS, NO.4.....	
2 each	HERRICK KIDNEY CLAMP.....	9"
1 each	OCHSNER TROCAR, SIZE 20 FR.....	
2 each	DEAVER RETRACTOR.....	2" x 12"
1 each	METZENBAUM SCISSORS, CURVED.....	7"
1 each	BOZEMAN DRESSING FORCEPS, CURVED.....	10"



## SURGICAL INSTRUMENT SETS

### VENOUS SECTION SET

QTY .	DESCRIPTION
1 each	OPERATING SCISSORS, STR., SHARP/BLUNT..... 5 1/2"
2 each	HALSTEAD MOSQUITO FORCEPS. STRAIGHT..... 5"
2 each	HALSTEAD MOSQUITO FORCEPS. CURVED..... 5"
1 each	DRESSING FORCEPS, SERRATED..... 5 1/2"
1 each	CRILE-WOOD NEEDLE HOLDER, T.C. JAW..... 6"
1 each	ADSON TISSUE FORCEPS, W/MOUSE TEETH
4 each	BACKHAUS TOWEL CLAMP..... 5 1/4"

### RECTAL INSTRUMENT SET

QTY.	DESCRIPTION
1 each	OPERATING SCISSORS, STR., SHARP/BLUNT..... 5 1/2"
1 each	MAYO DISSECTING SCISSORS, STRAIGHT..... 6 3/4"
1 each	MAYO DISSECTING SCISSORS, CURVED..... 6 3/4"
8 each	ROCHESTER-PEAN FORCEPS, CURVED..... 6 1/2"
8 each	ROCHESTER-OCHSNER FORCEPS, CURVED..... 6 1/2"
6 each	PENNINGTON CLAMP, STRAIGHT..... 5 3/4"
8 each	CRILE FORCEPS, STRAIGHT..... 5 1/2"
2 each	DRESSING FORCEPS, SERRATED..... 6"
2 each	TISSUE FORCEPS, 1 x 2 TEETH..... 6"
2 each	MAYO-HEGAR NEEDLE HOLDER, T.C. JAW..... 7"
1 each	SUTURE WIRE SCISSORS, ANGULAR..... 4 1/4"
1 each	GROOVED DIRECTOR..... 6"
2 each	PROBE, W/EYE, SILVER..... 6"
4 each	ALLIS FORCEPS, 5 x 6 TEETH..... 7 3/4"
1 each	BUIE PILE CLAMP..... 8 1/4"
6 each	PRATT "T" SHAPED FORCEPS..... 5 1/2"
1 each	SMITH ANAL RETRACTOR
1 each	SIM SPECULUM, FENESTRATED BLAD.E
1 each	HIRSCHMAN ANASCOPE, SMALL
1 each	HIRSCHMAN ANASCOPE, MEDIUM
1 each	HIRSCHMAN ANASCOPE, LARGE
6 each	BACKHAUS TOWEL CLAMP..... 5 1/2"
6 each	FOERSTER SPONGE FORCEPS, STRAIGHT, SERR..... 9 1/2"

### NORMAL DELIVERY SET

QTY .	DESCRIPTION
1 each	LARGE BOWEL
2 each	SIM,S SPACULLM (SMALL, LARGE)
1 each	EPISOTOMY SCISSOR
1 each	NON TOOTHED FORCEPS
2 each	ARTERY FORCEPS STRAIGHT (SMALL, LARGE)
2 each	ARTERY FORCEPS CURVED
3 each	SPONG HOLDING FORCEPS
1 each	NEEDLE HOLDER MEDIUMSIZE
1 each	KIDNEY TRAY BIG SIZE
2 each	KIDNEY TRAY SMALL SIZE



## D&C SET

QTY .	DESCRIPTION
1 each	INSTRUMENT TRAY
2 each	BOWEL SMALL AND MEDIUM
2 each	SIM,S SPACULUM
3 each	SPONG HOLDER
12 each	DILATOR SET IN ALL SIZE
1 each	MATALIC CATHETER
1 each	B.P HANDLE NO 3
1 each	TISSUE SCISSOR
3 each	SUCTION CURETTE
3 each	CURETT WITH HANDLE SMALL, MEDIUM, LARGE
2 each	TOOTHED AND NON TOOTHED FORCEPS
2 each	COMPLETE SET OF CURETTE
1 each	WALL, SPACULUM FORCEPS

### MICRO SURGERY SET (MAJOR SET)

complete set includes one each of the following:

QTY .	DESCRIPTION	
1 each	MICRO TYING FORCEPS	4 3/8" 0.3mm tip
1 each	BARRAQUER NEEDLE HOLDER	5" curved, with lock
1 each	MICRO SCISSORS	5" straight 1x2 teeth
1 each	GRAEFE IRIS FORCEPS	4" straight 1x2 teeth
1 each	MICRO CLAMPS APPLICATOR	5 1/2"
1 each	APPROXIMATION CLAMP	without suture holding frame
1 each	MICRO SCISSORS (REILL)	5 1/2" curved, serrated
1 each	PLATFORM TYING FORCEPS	5 1/2" 0.7mm tip
1 each	HEPP-SCHEIDEL DISSECTING SCISSORS	5 1/2" curved
1 each	CLAMP BOX	for micro clamps
1 each	STERILIZATION AND INSTRUMENT CASE	for eight piece micro set
1 each	INSTRUMENTS RACK	for eight piece micro set

### MICRO SURGERY SET (MINI SET)

QTY .	DESCRIPTION	
1 each	PLATFORM TYING FORCEPS	5 1/2" 0.7mm tip
1 each	BARRAQUER NEEDLE HOLDER	5" curved with lock
1 each	MICRO SCISSORS	5" curved, long blade, round handle
1 each	STERILIZATION AND INSTRUMENT CASE	for three piece micro set





---

# ***Index***

---

# INDEX



DESCRIPTION	PAGE #	DESCRIPTION	PAGE #
<b>A</b>			
Abadie Intestinal Clamp Forceps .....	346	Arruga Needle Holders .....	170, 171
Abdominal Retractors .....	286, 373	Arthroscope Basket .....	568
Abraham Knives .....	33	Articulated Tension Device .....	425
Abraham Tonsil Holding Forceps.....	541	Asch Septum Forceps .....	530
Adlerkreutz Tissue Forceps .....	99	Atraumatic Dressing Forceps .....	108
Adson / Micro-adson Tissue & Dressing Forceps .....	106	Aufranc Retractor .....	466
Adson Bone Rongeurs .....	481	Aufricht Rasp .....	526
Adson Clip Applying Forceps.....	418	Auvard Vaginal Specula.....	370
Adson Dressing Forceps T.c. ....	117	Ayre Knives .....	33
Adson Elevator .....	461	<b>B</b>	
Adson Haemostatic Forceps .....	121, 123	Babcock Intestinal Forceps T.c.....	349
Adson Needle Holders.....	165	Babcock Intestinal Forceps .....	333, 334, 335, 349
Adson Periosteal Elevator .....	463, 465	Babinsky Hammer .....	02
Adson Retractor.....	269, 274, 275	Baby Crile-Wood Needle Holders T.c. ....	179
Adson Suction Tube .....	18	Baby Crile-Wood Needle Holders.....	163
Adson Tissue & Dressing Forceps T.c. ....	116	Baby Metzenbaum Super Cut Scissors.....	82
Adson-Baby Retractor .....	273	Baby-Collin Retractor .....	285
Adson-Brown Tissue & Dressing Forceps .....	106	Baby-Crile Haemostatic Forceps .....	121
Adventitia Scissors .....	75	Baby-Doyen Intestinal Clamps .....	336
Aesculap Forceps .....	559	Baby-Kocher Intestinal Clamps .....	336
Aesculap Sponge & Dressing Forceps .....	155	Baby-Mikulicz Haemostatic Forceps .....	143
Agnew Tympanum Needle.....	497	Baby-Mixer Haemostatic Forceps .....	124
Alar Hooklets, Nasal Retractors .....	515	Baby-Mosquito (Hartmann) Haemostatic Forceps .....	120
Alexander Gouges .....	458	Baby-Overholt Haemostatic Forceps.....	124
Alexander Retractor.....	467	Baby-Roux Retractors .....	231
Alexander Uterine Biopsy Forceps .....	390	Baby-Satinsky De Bakey Vascular Clamps .....	310
Allis Intestinal Forceps T.c .....	349	Baby-Sdson Haemostatic Forceps .....	124
Allis Intestinal Forceps.....	331, 334, 349	Baby-Senn Mueller Retractors .....	214
Allison Retractor .....	255, 321	Backhaus Clip Towel Forceps.....	149
Allport Hooklet .....	203	Backhaus Towel Forceps.....	148
Alligator Ear Forceps & Ear Syringe .....	502	Bacon Bone Rongeurs .....	479
Alm Retractor.....	265	Bailey Rib Spreader.....	320
Amputation & Resection .....	36	Bailey-Gibbon Rib Spreader .....	320
Amputation Knife .....	36	Bainbridge Haemostatic Forceps .....	134
Amputation Saw .....	438	Bainbridge Intestinal Clamps .....	338
Anaestophon Stethoscope .....	03	Bainbridge Vascular Clamps.....	295
Anderson-Adson Retractor .....	274	Bakes Gall Duct Dilator .....	353
Anderson-Neivert Chisel .....	518	Balfour Retractor .....	280
Andrews-Pynchon Suction Tubes.....	20	Balfour-Baby Retractor .....	281
AO Coupling Fiber Handle .....	421	Ball & Socket Towel Forceps .....	149
AO Coupling T-handle .....	421	Ballenger Septum Gouge .....	517
Arruga Needle Holders T.c.....	186	Ballenger Swivel Knife.....	516



## INDEX

DESCRIPTION	PAGE #	DESCRIPTION	PAGE #
Bane Bone Rongeurs .....	481	Billeau Curette .....	499
Barbara Tympanum Needle .....	498	Birch Trocar .....	22
Bardeleben Bone Holding Forceps .....	429	Birkett Haemostatic Forceps .....	135
Barnes-Neville Obstetrical Forceps .....	400	Blade Holder Blade Breaker .....	28
Barnhill Adenoid Curettes .....	551	Blade Retractor .....	469
Barr Rectal .....	347	Blake Gall Stone Forceps .....	356
Barraquer Cilia Forceps .....	113	Blake Suction Curettes .....	377
Barraquer Micro Scissors .....	71	Blalock Clamp .....	320
Barraquer Needle Holders .....	171	Blohmke Tonsil Holding Forceps .....	541
Barraquer Needle Holders .....	171	Blood Scoop Retractor .....	264
Barraquer/with Catch Needle Holders .....	171	Blount Knee Retractor .....	466
Barraquer-Troutman Needle Holders .....	171	Blount Retractors .....	230
Barrett Tenaculum Forceps .....	375	Blumenthal Bone Rongeurs .....	479
Barth Ear Curette .....	498	Boettcher Tonsil Scissors .....	533
Battery Handle .....	06	Böhler Bone Rongeurs .....	483
Baumgartner Needle Holders T.c. ....	174	Boies Septum Forceps .....	530
Baumgartner Needle Holders .....	162	Bone Holding Forceps .....	434
Beacham Tonsil Forceps .....	543	Bone Hook .....	437, 453
Beck De Bakey Vascular Clamps .....	315	Bone Shear .....	327
Beck De Bakey Vascular Clamps .....	316	Bone Tamp Endoscopic .....	447
Beckmann (Negus) Adenoid Curettes .....	551	Bone Tamps .....	453
Beckmann Adenoid Curettes .....	551	Bonney Dissecting Dressing Forceps T.c. ....	118
Beckmann Nasal Speculum .....	510	Bonney Tissue Forceps .....	102
Beckmann-Adson Retractor .....	275	Bose Hook .....	206
Beckmann-Eaton Retractor .....	275	Bose Hooklet .....	555
Bedpan .....	567	Boucheron Ear Specula .....	493
Beebee Wire Cutting Scissors .....	68, 69	Bowl With Lip .....	565
Beer Cilia Forceps .....	113	Bowl .....	565
Bellucci Micro Ear Forceps .....	505	Bowman Lacrimal Probes .....	195
Bending Iron .....	426	Box With Filter .....	562
Bending Template .....	425	Boynton Needle Holders T.c. ....	186
Bengolea Haemostatic Forceps .....	130	Boynton Needle Holders .....	170
Bennett Knee Retractor .....	466	Boys-Allis Intestinal Forceps .....	332
Bensaude Intestinal Rectal .....	348	Bozemann Haemostatic Forceps .....	141
Berger Uterine Biopsy Forceps .....	391	Bozemann Needle Holders T.c. ....	173
Bergmann Bandage Scissors .....	77	Bozemann Needle Holders .....	163
Bergmann Mallet .....	441	Bozemann-Douglas Haemostatic Forceps .....	141
Bergmann Scissors .....	79	Bozemann-Fritsch Uterine Flushing Tube .....	386
Berliner Hammer .....	02	Brand Tendon Forceps .....	473
Bernhard Towel Forceps .....	149	Brantley-Turner Retractor .....	255
Beyer Bone Punch .....	528	Braun Decapitating Hook .....	395
Beyer Bone Rongeurs .....	483	Braun Obstetrical Forceps .....	400
Beyer Mastoid Rongeurs .....	504	Braun Suction Curettes .....	377
Beyer Rongeur .....	482	Braun Tonsil Forceps .....	543, 545
Biemer Suction Tube .....	14	Braun Vaginal Speculum .....	366

# INDEX



DESCRIPTION	PAGE #	DESCRIPTION	PAGE #
Braun-Stadler Bandage Scissors .....	78	Busch Bandage Scissors.....	78
Breisky Obstetrical Measuring Forceps .....	398	Byrd Suction Tube .....	13
Breisky Wiener Modell / Vienna Pattern Retractor .....	369		
Brewster Retractor.....	261	<b>C</b>	
Bridge Haemostatic Forceps .....	134	C - Clamp Drill Guide .....	428
Briesky Vaginal Speculum .....	367	C.W. Mayo Abdominal Retractor .....	261
Bristow's Periosteal Elevators .....	462	Cairns Haemostatic Forceps .....	124
Brodie Probe.....	196	Calipers .....	12
Brom Retractor .....	209	Calipers, Dynamometers, Flexometer .....	11
Broncho-Esophagoscopy Forceps .....	559	Caplan Plaster Shears.....	489
Brophy (Sullivan) Scissors.....	64	Cardinale Operating Scissors T.c. ....	88
Brophy Dressing Forceps .....	98	Cardinale Scissors.....	47
Brophy Tissue Forceps.....	98	Cardiovascular Scissors .....	58
Brown Needle Holders.....	162, 165	Carmalt Splinter Forceps .....	114
Brown Tissue & Dressing Forceps .....	106	Carrel Haemostatic Forceps.....	120
Bruenings Septum Forceps .....	513	Carroll Caliper .....	11
Bruenings Tongue Depressor .....	534	Carroll Needle Holders T.c.....	179
Bruenings Tonsil Snares .....	548	Carroll Needle Holders .....	163
Bruner Retractor .....	237	Carroll Periosteal Elevator .....	465
Brünings Forceps .....	559	Carroll Tendon Forceps .....	473
Brunings Knives .....	33	Caspar Hooklet .....	204
Brunings Septum .....	520	Caspar Laminectomy Rongeur.....	409
Brünings Tonsillectomy Forceps .....	560	Caspar Retractor .....	278
Brunner Intestinal Forceps .....	337	Caspar Retractors .....	227
Brunner Retractor .....	238	Castaneda De Bakey Vascular Clamps....	311-313
Brunner Rib Sternum Shears .....	328	Castaneda Rib Retractors .....	325
Bruns Bandage Scissors .....	77	Castroviejo Blade Holder .....	28
Bruns Bone Curettes .....	442, 443, 445	Castroviejo Caliper .....	12
Bruns Plaster Scissors T.c. ....	92	Castroviejo Micro Scissors .....	71, 72
Bryant Sponge & Dressing Forceps .....	152	Castroviejo Needle Holders T.c .....	185, 187
Buchwald Tongue Depressor .....	534	Castroviejo Needle Holders.....	171
Buck Applicator.....	199	Castroviejo Olsen Heager / Needle Holders / Scissors .....	170
Buck Ear Curette .....	498	Castroviejo-Epker Caliper.....	12
Buck Ear Polypus Forceps .....	501	Cather Tray .....	562
Buck Hammer .....	01	Catheter Dilator .....	354
Buck Stitch Scissors .....	67	Catlin Knife .....	36
Buck Tympanum Needle.....	497	Catlin Knives.....	34
Bucket with lid.....	566	Chadwick Scissors .....	66
Buckley Retractor .....	265	Chandler Bone Elevator .....	461
Buelau Trocar .....	21	Chaput Haemostatic Forceps .....	154
Bulldog Clamp .....	291	Chaput Intestinal Forceps.....	332
Burford Rib Retractors .....	326	Charnley Bone Forceps .....	430
Burke Uterine Biopsy Forceps.....	389	Charnley Tissue & Dressing Forceps .....	101
Burnham Bandage Scissors .....	79		



## INDEX

DESCRIPTION	PAGE #	DESCRIPTION	PAGE #
Charnley-Mueller Compression Clamp.....	478	Collin Rib Shears.....	329
Charriere Saw.....	36	Collin Scalpel Handle.....	25
Charriere Saw.....	81, 438	Collin Sponge & Dressing Forceps.....	156, 161
Cheatel Box Joint Sterilizing Forceps.....	569	Collin Suction Curettes.....	378
Cheatel Screw Joint Sterilizing Forceps.....	569	Collin Suture Forceps.....	200
Cheek Retractors & Tongue Depressors.....	540	Collin Vaginal Speculum.....	362
Cheek & Lip Retractor Movable.....	244	Collin-Duval Tissue Forceps.....	103
Cheron Sponge & Dressing Forceps.....	156	Collin-Hartmann Retractors.....	214
Chevalier-Jackson Tracheal Tube.....	553	Colver Tonsil Forceps.....	542
Childe Suture Forceps.....	200	Combination Wrench.....	425
Chisel Handle.....	456	Compression Device.....	425
Chisels / Osteotomes.....	448	Cone Clip Applying Forceps.....	418
Christophe Haemostatic Forceps.....	122	Cone Retractor.....	268
Church Vascular Scissors.....	61	Conventional Laryngoscope Set.....	08
Cilia Forceps.....	113	Converse Alar Hooklet.....	515
Cinelli Osteotome.....	519	Converse Chisel.....	518
Citelli Laminectomy Rongeur.....	410	Converse Needle Holders T.c.....	178
Citelli Mastoid Rongeurs.....	504	Cooley Bakey Vascular Clamps.....	317
Classon Scissors.....	56	Cooley De Bakey Vascular Clamps.....	316
Cleveland Bone Cutting Forceps.....	487	Cooley Arteriotomy Scissors.....	56
Cleveland Bone Rongeur.....	480	Cooley Atraumatic Dressing Forceps.....	108
Cleveland-Gardner Bone Cutting Forceps.....	486	Cooley Cardiovascular Scissors.....	57
Cloward Modif. Retractor.....	277	Cooley Clamping Forceps.....	314
Cloward Retractor.....	288	Cooley De Bakey Vascular Clamps.....	301, 311
Cloward Spreader.....	419	Cooley Intracardiac Needle Holders T.c.....	177
Cloward-Type Laminectomy Rongeurs.....	404	Cooley Microvascular Needle Holders T.c.....	183
Cloward-Type Rongeur.....	405	Cooley Retractor.....	257
Clutton Bougies.....	354	Cooley Reverse Cut Scissors.....	52
Coakley Sinus Curettes.....	550	Cooley Rib Retractor.....	322
Coakley Trocar.....	22	Cooley Suction Tube.....	13
Cobb Chisel / Osteotomes.....	448	Cooley Vascular Forceps.....	321
Cobb Elevators.....	461	Cooley Vascular Scissors.....	54
Cobb Gouges.....	454	Cooley-Baumgaften Wire Twister T.c.....	180
Cobb Modif. Elevator.....	460	Cooley-Derra De Bakey Vascular Clamps.....	318
Cobb Spinal Elevator.....	460	Cooper Needle.....	192
Cobb Spinal Elevator Endoscopic.....	449	Cope Hooklets.....	213
Coller Haemostatic Forceps.....	122	Cordes Tonsillectomy Forceps.....	560
Collier Needle Holders.....	167	Corwin Needle Holders T.c.....	188
Collin Bone Holding Forceps.....	429	Corwin Round Scalpel Handle.....	28
Collin Intestinal Forceps.....	333	Coryllos Retractors.....	236
Collin Intestinal Forceps.....	334	Cottle Alar Hooklet.....	515
Collin Kidney Stone Forceps.....	351	Cottle Cartilage Crusher.....	530
Collin Knives.....	30, 34	Cottle Elevator.....	522
Collin Obstetrical Measuring Forceps.....	398	Cottle Hook.....	207
Collin Retractor.....	232, 282, 284, 285	Cottle Hooklet.....	203

# INDEX



DESCRIPTION	PAGE #	DESCRIPTION	PAGE #
Cottle Mallet.....	441	Cushing-Kocher Hooklet.....	218
Cottle Nasal Scissors .....	63	Cuticle Nipper .....	201
Cottle Nasal Speculum .....	508	Czerny Rectal .....	347
Cottle Nasal Speculum .....	509	Czerny Tonsil Forceps .....	545
Cottle Periosteal Elevator .....	522		
Cottle Retractor .....	215, 515	<b>D</b>	
Cottle Scissors T.c. ....	94	Dale Vascular Clamps .....	293
Cottle Septal Speculum .....	511	Dandy Haemostatic Forceps .....	121
Cottle-Kazanjian Bone Cutting Forceps .....	488	Dandy Vascular Scissors .....	59
Cottle-Neivert Alar Hooklet .....	515	Darling Retractor .....	268
Cottle-Neivert Hook .....	207	Dartigues Kidney Stone Forceps .....	351
Cotton Holder .....	566	Dartigues Seizing Forceps .....	376
Coupland Suction Tube .....	13	Davidson Retractors .....	236
Coupling Dental Handle .....	421	Davis Dura Dissectors .....	470
Crafoord Haemostatic Forceps.....	130, 137	Davis Nerve Separator & Spatula.....	416
Crafoord Lobectomy Scissors .....	57	Davis Sterilizing Forceps .....	569
Crafoord Scissors .....	62	Davis Tissue Forceps .....	103
Crafoord-Sellers Haemostatic Forceps .....	135	Davis-Boyle Mouth Gage.....	537
Crawford Retractor .....	263	Day Hooklet .....	205
Crile Haemostatic Forceps .....	121	De Bakey - Bahnson Vascular Clamps.....	299
Crile Hooklet .....	205	De Bakey - Mosquito Vascular Clamps .....	295
Crile Needle Holders .....	170	De Bakey - Rankin Vascular Clamps.....	295
Crile Retractors.....	230	De Bakey / Lightweight Tissue Forceps .....	107
Crile-Murray Needle Holders .....	168	De Bakey / Pediatric Vascular Clamps .....	319
Crile-Wood Needle Holders T.c .....	181, 172, 174	De Bakey Clamping Forceps .....	289
Crile-Wood Needle Holders .....	163, 176	De Bakey Femur Retractor .....	276
Crura-Nipper Micro Ear Forceps .....	506	De Bakey Needle Holders T.c.....	172
Crutchfield Skull Traction Tong Cups.....	403	De Bakey Tissue & Dressing Forceps .....	107
Curette .....	471	De Bakey Vascular Clamps .....	296, 300, 302-309
Cusco Vaginal Speculum.....	361, 362	De Bakey Vascular Scissors.....	54, 60
Cushing Bone Drills .....	423	De Lee Corner Retractors .....	262
Cushing Decompression Retractor .....	468	De Lee Obstetrical Forceps .....	400
Cushing Dressing Forceps T.c. ....	117	De Lee Obstetrical Measuring Forceps .....	398
Cushing Dressing Forceps.....	97, 119	De Lee Universal Retractors .....	262
Cushing Hand Drills .....	402	De Martel-Wolfson Anastomosis Clamps .....	342
Cushing Hook .....	207	De Vilbiss Vaginal Speculum .....	361
Cushing Hooklet .....	218	Dean Scissors T.c. ....	92
Cushing Laminectomy Rongeurs .....	404	Dean Tonsil Scissors .....	533
Cushing Love Gruenwald Spurling Rongeur .....	405	Dean-Dellicate Scissors .....	51
Cushing Periosteal Elevators .....	463,465	Dean-Shallcross Haemostatic Forceps .....	135
Cushing Pituitary Spoon .....	446	Deaver Operating Scissors.....	40
Cushing Tissue Forceps T.c.....	117	Deaver Retractor .....	241, 242, 246-247
Cushing Tissue Forceps .....	98, 119	Debakey Atraumatic Dressing Forceps .....	108
Cushing Vein Retractor .....	468	Debakey Bulldog Clamps .....	290



## INDEX

DESCRIPTION	PAGE #	DESCRIPTION	PAGE #
Debakey Cardiovascular Needle		Dissector.....	471
Holders T.c.....	177	Dittel Urethral Catheters.....	355
Debakey Endarterectomy Scissors.....	58	Dixon-Lovelace Haemostatic Forceps.....	136
Debakey Micro Needle Pulling Tissue		Douay Uterine Biopsy Forceps.....	392
Forceps T.c.....	118	Double Prong Micro Hook.....	202
Debakey Scissors T.c.....	93	Douglas Cilia Forceps.....	113
De-Bakey Suction Tube.....	17	Douglas Trocar.....	21
Debakey Vascular Scissors.....	55	Doyen Intestinal Clamps.....	336, 339
Debakey-Diethrich Bulldog Calmps.....	292	Doyen Lateral Speculum.....	369
Debakey-Potts Scissors.....	55	Doyen Mallets.....	440
Debakey-Vascular/Extra Light Needle		Doyen Myoma Screw.....	376
Holders T.c.....	179	Doyen Needle Holders.....	167
Decker Intervertebral Disc Laminectomy		Doyen Operating Scissors.....	46
Rongeur.....	414	Doyen Probe.....	196
Dejerine Hammer.....	01	Doyen Retractor.....	244, 284
Demartel Vascular Scissors.....	58	Doyen Rib Raspatory.....	461
Denhardt Mouth Gag.....	535	Doyen Rib Shears.....	329
Denis-Browne Retractor.....	286	Doyen Towel Forceps.....	148
Depth Gauge.....	425	Doyen Vaginal Retractors.....	252
Derf Needle Holders T.c.....	178, 181	Doyen Vaginal Specula (for Children	
Derf Needle Holders.....	167	& Virgins).....	368
Deschamps Needle.....	192-194	Doyen Vaginal Speculum.....	367
Desjardins Gall Duct Dilator.....	353	Doyen-Collin Mouth Gag.....	535
Desjardins Gall Stone Forceps.....	357	Doyen-Stillé Retractors.....	239
Desjardins Haemostatic Forceps.....	137	Dressing Forceps T.c.....	119
Desmarres Hooklet.....	218	Dressing Jar With Knob.....	565
Devibiss Clip Applying Forceps.....	418	Dressing Jar.....	565
Diagnostic Set.....	05	Drill Bits.....	420
Diagnostic Sets With Standard Illumination.....	05	Drill Guide.....	428
Diamant Pin Cutter.....	490	Drill Pointed Guide.....	428
Dick Haemostatic Forceps.....	146	Drill Sleeve.....	425, 427
Dieffenbach Knives.....	29, 30, 34	Drill Small Pointed.....	428
Diethrich/Micro Coronary Clamp.....	291	Dubois Scissors.....	47
Dietrich Vascular Clamps.....	293	Duckbill Alligator Ear Forceps.....	502
Dingmann Bone Holding Forceps.....	429	Duehrssen Dressing Forceps.....	103
Dingmann Mouth Gage.....	539	Duehrssen Tissue Forceps.....	103
Director.....	196	Duke Trocar.....	22
Dissecting & Gynecological Scissors.....	41, 47	Dunhill Haemostatic Forceps.....	123
Dissecting Ket.....	10	Duplay Sponge & Dressing Forceps.....	153
Dissecting Knives.....	29-33, 34, 35	Duplay Sponge Forceps.....	159
Dissecting Scissors.....	51	Duplay Tonsil Forceps.....	543
Dissecting Scissors T.c.....	89, 90	Duplex Stethoscope.....	03
Dissecting Scissors.....	43, 50, 62	Duplex-Baby Stethoscope.....	03
Dissecting Sets.....	06	Dura Twist Hook.....	416
Dissecting Tissue Forceps T.c.....	117	Durante Tissue Forceps.....	102
Dissection Scissors.....	75		

# INDEX



DESCRIPTION	PAGE #	DESCRIPTION	PAGE #
Dust Bin .....	567	.....	431
Duval Intestinal Forceps .....	332	Farrell Applicator .....	198, 199
Duval Intestinal Forceps .....	335	Faulkner Ehtmoid Currettes .....	550
Duval Intestinal Forceps .....	349	Faure Biopsy Forceps .....	394
Duval-Collin Intestinal Forceps .....	332	Favaloro Coronary Scissors .....	56
<b>E</b>		Favaloro Vascular Scissors .....	59
Ear Forceps .....	507	Fehland Intestinal Forceps .....	337
Ear Hooklets & Tympanum Needle.....	500	Feilchenfeld Splinter Forceps .....	114
Ear Hooklets, Tympanum Needle .....	499	Ferguson Bone Holding Forceps .....	429
Ear Polypus Forceps .....	501	Ferguson-Ackland Mouth Gag.....	535
Ear Specula .....	493	Ferguson-Moon Rectal Retractors .....	258
Ear Speculum .....	494	Fergusson Operating Scissors .....	40
Echlin / Stille-Luer Bone Rongeur .....	482	Fergusson Suction Tube.....	19, 531
Echlin Bone Rongeur.....	484	Fergusson Tubing Clump .....	150
Eicken Tonsillectomy Forceps .....	560	Ferris - Smith Laminectomy Rongeur .....	413
Eiselsberg Scissors .....	66	Ferris-Smith Tissue Forceps.....	102
Eiselsberg-Matheiu Needle Holders T.c.....	189	Fiber Key Handle .....	421
Electric Mirror.....	552	Fiberoptic & Disposable Laryngoscope Set.....	09
Emmet Hook.....	206	Fiberoptic Laryngoscope Set.....	08
Emmet Sponge & Dressing Forceps .....	156	Finocchietto (Modif.) Retractor .....	323
Endoscope Basket.....	568	Finocchietto / Baby Rib Retractors .....	325
Enema Cane.....	567	Finocchietto Infant Rib Retractor .....	322
Engel Plaster Saw .....	81, 438	Finocchietto Needle Holders .....	164
Engl. Modell Towel Forceps .....	148	Finocchietto Rib Retractors .....	325
Ent-Dean Vascular Scissors .....	57	Finochietto Haemostatic Forceps .....	132
Enterotomy Scissors.....	62	Finochietto Needle Holders T.c.....	175
Eppendorf Uterine Biopsy Forceps.....	391, 392	Finochietto Vascular Scissors.....	57
Esmarch Knife .....	77	Finsen Retractor .....	265
Esmarch Scissors .....	77	Finsterer Suction Tubes.....	24
Eufrate Pasque Needle Holders T.c.....	179	Fisch Ear Hooklet .....	500
Evans Dressing Forceps.....	119	Fisch Hooklet.....	202
Evans Pelvic Needle Tissue Forceps.....	119	Flat Gouge.....	455
Eves Tonsil Snares .....	548	Flat Nose Pliers .....	473
Ewald / Hudson Tissue & Dressing Forceps ....	106	Flat Nose Parallel Pliers .....	474
Extraction Pliers .....	475, 476, 491	Flat-Nose Pliers .....	475
<b>F</b>		Fletcher Sponge Forceps .....	158
Face-Life, Dissecting, Nasal Scissors .....	44	Fleurant Trocar .....	21
Farabeuf Periosteal Elevators .....	464	Foerster Sponge Forceps .....	160
Farabeuf Retractors.....	232	Foerster-Ballenger Sponge Forceps .....	159
Farabeuf-Lambotte Bone Holding Forceps .....		Foerster-Ballenger Sponge Forceps .....	160
		Foman Rasp .....	453
		Fomon Alar Hooklet.....	515
		Fomon Hook .....	207
		Fomon Nasal Scissors.....	63
		Fomon Osteotome.....	519





## INDEX

DESCRIPTION	PAGE #	DESCRIPTION	PAGE #
Fomon Rasp .....	527	Gelpi Vaginal Retractor .....	276
Fomon Scissors T.c. ....	94	Gelpi-Isoltite Retractor .....	268
Fomon Scissors .....	44	Gemini Haemostatic Forceps .....	133
Forceps Jar .....	566	General Instruments .....	195-199, 201
Foregger Laryngoscope .....	07	Gerald Dressing Forceps .....	97, 98
Fowler Knives .....	33	Gerald Tissue Forceps .....	98
Fraenkel Tonsillectomy Forceps .....	560	Gerster Bone Clamp .....	432
Frazier 30° Suction Tube .....	18	Gerzog Mallet .....	441
Frazier 45° Suction Tube .....	18	Gerzog-Sexton Tympanum Needle .....	497
Frazier Dura Dissectors .....	470	Giertz-semb Rib Sternum Shears .....	328
Frazier Hooklet .....	202	Gigli Handle .....	438
Frazier Nerve Hooks .....	416	Gigli Saw .....	438
Frazier Suction Tube .....	18-20, 531	Gillies Hooklet .....	202
Frazier-Ferguson Suction Tube .....	18	Gillies Needle Holders .....	166, 176
Freer Alar Hooklet .....	515	Gillies Nerve Hooks .....	416
Freer Elevator .....	324, 452, 520, 523	Gillies Osteotome .....	518
Freer Hooklet .....	202	Gillies Tissue Forceps .....	99
Freer Knife .....	324	Gil-Vernet Hooklet .....	217
Freer Mucous Knife .....	520	Gil-Vernet Retractors .....	235
Freer Raspatory .....	520, 522, 520	Glabella Rasps & Nasal Rasps .....	527
Freer Separator & Elevator .....	521	Glabella Rasps, Nasal Rasps .....	526
Freer Septum Chisel .....	517, 522	Glover De Bakey Vascular Clamps .....	302, 311
Freer Septum Gouge .....	517	Glover Vascular Clamps .....	305
Freer Yasargil Dissector .....	520, 523	Gluck Rib Shear .....	327
French-Eye Needle Holders T.c. ....	174	Goelet Retractor .....	251
Frenzel Tongue Depressor .....	534	Goldman-Fox (spezial) Scissors .....	51
Fricke Artery Forceps .....	151	Goldman-Fox Operating Scissors T.c. ....	88
Friedman & Mini-Friedman Bone Rongeurs .....	479	Goldman-Fox Scissors .....	51
Friedmann Retractor .....	373	Goldman-Fox Super Cut Scissors .....	82
Fritch Retractor .....	244	Good Scissors .....	64
Fulton Scissors .....	53	Good Tonsil Scissors .....	533
Furnal .....	567	Gorney Scissors T.c. ....	91
<b>G</b>		Gorney Septal Scissors .....	489
G Loves Box .....	562	Gorney Suction Tube .....	19
Galabin Uterine Sounds .....	384	Gosset Retractor .....	279, 281
Galipots .....	566	Gourdet Uterine Depressor .....	378
Gall Stone Forceps .....	357	Gradle Cilia Forceps .....	113
Galt Bone Drill .....	402	Graduated Metal Ruler .....	11
Garland Haemostatic Forceps .....	136	Graduated Tape Measurer .....	11
Gauss Obstetrical Forceps .....	397	Graefe Dressing Forceps T.c. ....	111
Gayne Evans Tonsil Dissector .....	546	Graefe Hook .....	207
Gellhorn Biopsy Forceps .....	394	Graefe Hooklet .....	205
Gelpi Skin & Vaginal Retractor .....	276	Graefe Tissue & Dressing Forceps T.c. ....	111
		Graefe Tissue Forceps T.c. ....	111
		Graig Septum Forceps .....	513

# INDEX



DESCRIPTION	PAGE #	DESCRIPTION	PAGE #
Graig-Domnick Septum Forceps .....	513	Hard Tonsil Dissector .....	547
Graves Vaginal Speculum Leep / Lietz .....	360	Harrington Retractors .....	245
Graves Vaginal Speculum .....	360	Harrington Spinal Elevator .....	449, 460
Gray Haemostatic Forceps .....	137, 142	Harris Angled Suture Forceps .....	358
Grazil Dissecting Scissors .....	39	Hartmann / French Tuning Forks .....	495
Grazil Operating Scissors .....	39	Hartmann Alligator Ear Forceps .....	502
Green Retractors .....	228	Hartmann Bone Rongeurs .....	479
Green-Armytage Obstetrical Forceps .....	397	Hartmann Ear Hooklet .....	500
Green-Armytage Placenta Forceps .....	396	Hartmann Ear Specula .....	493
Gregory Vascular Clamps .....	294	Hartmann Eustachian Catheters .....	494
Gregory-Soft Clamping Forceps .....	289	Hartmann Hook .....	206
Grey Turner Haemostatic Forceps .....	123	Hartmann Nasal Cutting Forceps .....	529
Groenholm Retractor .....	209	Hartmann Nasal Speculum .....	510
Gross Ear Hooklet .....	500	Hartmann Septum Forceps .....	512
Gross Sponge & Dressing Forceps .....	153	Hartmann Tongue Depressor .....	540
Gruber Aural Specula .....	493	Hartmann Tuning Forks .....	495
Gruenwald-Henke Nasal Cutting Forceps .....	529	Hartmann Tuning Forks .....	496
Guedel-Negus / Miller Laryngoscope .....	07	Hartmann-French Tuning Forks .....	496
Guedel-Negus Laryngoscope .....	06	Hartmann-Halle Nasal Speculum .....	510
Gum Locklin Scissors T.c. ....	92	Hartmann-Hoffmann Alligator Ear Forceps .....	502
Gum, Operating Scissors .....	64	Hartmann-Noyes Alligator Ear Forceps .....	502
Gum, Stitch Scissors .....	66	Harvey Scissors .....	66
Gumco Clamp .....	359	Harvey Wire Cutting Scissors .....	69
Guthrie Hooklet .....	202	Haslinger Tonsil Snares .....	549
Guyon Dilating Bougies .....	354	Heaney / Ballantine Haemostatic Forceps .....	136
Guyon Haemostatic Forceps .....	138	Heaney / Rezak Haemostatic Forceps .....	136
Guyon Urethral Catheters .....	355	Heaney Haemostatic Forceps .....	139, 144, 145
<b>H</b>		Heaney Modif. Haemostatic Forceps .....	144
Haberer Intestinal Clamp Forceps .....	345	Heaney Needle Holders .....	165, 176
Haig Ferguson Obstetrical Forceps .....	400	Heaney-Gyne Needle Holders T.c .....	182
Haight Rib Retractor .....	323	Heaney-Kanter Haemostatic Forceps .....	139
Hajek Mallet .....	441	Heany Retractor .....	262
Hajek-Kofler Laminectomy Rongeur .....	410	Heath Vascular Scissors .....	54
Hakansson Bone Rongeurs .....	481	Hegar Gyne Uterine Dilators .....	388
Halle Elevator .....	520, 522	Hegar Uterine Dilators .....	387
Halle Nasal Speculum .....	511	Hegar-Baumgartner Needle Holders .....	168
Halle Scissors .....	64	Hegemann-Diethrich Scissors .....	52
Halsey Needle Holders T.c. ....	178	Hegenbarth Suture Forceps .....	200
Halsey Needle Holders .....	167, 176	Heiss Haemostatic Forceps .....	130, 132, 140
Halsted Haemostatic Forceps .....	122, 130	Heiss Retractor .....	265
Halsted-Mosquito Haemostatic Forceps .....	120, 130	Heister Mouth Gag .....	536
Hank Gyne Uterine Dilators .....	387	Hening Spreader .....	81
Hank Uterine Dilators .....	387	Henke Tonsil Dissector .....	546
		Henley Retractor .....	267
		Hennig Plaster Shears .....	489



## INDEX

DESCRIPTION	PAGE #	DESCRIPTION	PAGE #
Herba Miliun Knife & Comedone Extractor.....	324	Houzel Retractor .....	267
Herbert Mallets .....	440	Howasth Elevator .....	521, 523
Herrick Haemostatic Forceps .....	135	Huber Forceps .....	559
Hertzler Retractor .....	281	Hudson Bone Drills .....	423
Hertzler Rib Retractor .....	324	Hudson Brace Bone Drill .....	402
Herz Tendon Seizing Forceps.....	157	Hulka Gyne Cervical Forceps.....	374
Herzfeld Retractors .....	215	Hulka-Kenwick Uterine Elevating & Manipulating Forceps .....	351
Hess Retractor.....	216	Hunt .....	105
Hexagonal Head .....	424	Hunter Splinter Forceps .....	114
Hey Groves Bone Holding Forceps .....	431	Husfeldt Vascular Clamps.....	294
Heymann Nasal Scissors .....	63, 514		
Heymann Septum Forceps .....	513		
Heymann-Knight Septum Forceps .....	512		
Heywood Smith Sponge Forceps .....	158		
Hibbs Chisel / Osteotomes .....	448		
Hibbs Chisel Endoscopic .....	448		
Hibbs Gougs Endoscopic .....	454		
Hibbs Osteotomes Endoscopic .....	448		
Hibbs Retractor .....	468		
Hibbs-Spratt Bone Curettes .....	442		
Hill Elevator .....	521		
Hill Ferguson Rectal Retractors.....	258		
Hirschmann Intestinal Rectal.....	348		
Hoer Dura Dissectors .....	470		
Hoer Elevator .....	460		
Hoer Periosteal Elevator.....	461		
Hoer Periosteal Elevators .....	463		
Hofer Tonsil Snares .....	549		
Hohmann Bone Levers.....	467		
Hollow Gouge .....	455		
Hollow Needle .....	15		
Holsher Retractor .....	216		
Holzbach Retractor.....	285		
Hook Retractor .....	555		
Hooklet .....	204, 218		
Hooklet & Skin Hooks.....	202, 203, 205-207		
Hooklet .....	217		
Hooklets, Retractors .....	208-211, 213		
Horizontal Retractor .....	267		
Horrocks Uterine Sound .....	384		
Horsley Bone Cutting Forceps.....	488		
Horsley Dura Dissectors.....	470		
Hosel Retractors .....	240		
House Suction Tubes .....	24		
House-Dieter Micro Ear Forceps .....	504		
		I	
		I.M.A Rib Retractor .....	324
		Impactors / Tamps .....	447
		Incision Operating Scissors .....	40
		Indo Box Round.....	566
		Indo Box With Silver Frame.....	564
		Inge Retractor.....	288
		Inge Spreader.....	419
		Insert Drill Sleeve .....	428
		Instrument Boiler Electric.....	563
		Instrument Boiler With Stand.....	563
		Instrument Boiler .....	563
		Instrument Box With Clip .....	562
		Instrument Tray With Cover.....	562
		Instrument Tray Without Cover.....	564
		Instrument Tray.....	562
		Instruments Box Without Clip .....	562
		Intestinal & Tissue Grasping Forceps.....	331-333
		Intestinal Clamps .....	336
		Intracardiac Needle Holders T.c.....	172
		Iowa Tonsil Forceps.....	544
		Iowa Uterine Forceps .....	376
		Iris Angular.....	49
		Iris Scissors T.c.....	93, 94
		Iris Scissors .....	48, 49
		Iris Super Cut Scissors .....	82
		Iris, Tendon Scissors.....	48
		Israel Retractors .....	235
		Iterson Hook .....	206
		Iterson Hooklet .....	555
		Ives-Fansler Rectal.....	347

# INDEX



DESCRIPTION	PAGE #	DESCRIPTION	PAGE #
<b>J</b>		Jurasz Laryngeal Polypus Forceps .....	558
Jackson Burrows Retractor .....	276	<b>K</b>	
Jackson Retractor .....	555	Kader Retractor .....	248, 263
Jackson Tendon Seizing Forceps .....	157	Kahler Tonsillectomy Forceps .....	560
Jackson Vaginal Specula .....	365	Kallmorgen Vaginal Retractor .....	367
Jacob's Chuck .....	421	Kallmorgen Vaginal Speculum .....	367
Jacobs Tenaculum Forceps .....	376	Kalt Needle Holders T.c. ....	187
Jacobs Tonsil Forceps .....	545	Kalt Needle Holders .....	171
Jacobson Haemostatic Forceps .....	122	Kantrowitz Haemostatic Forceps .....	134
Jacobson Heavy Style Needle Holders T.c. ....	187	Kay De Bakey Vascular Clamps .....	303
Jacobson Needle Holders T.c. ....	185, 186, 173, 187	Kaye Face-Lift Scissors .....	44
Jacobson Needle Holders .....	164	Kaye Scalpel Handle .....	28
Jager Tendon & Cross Ligament Passing Forceps .....	157	Kaye-Millard Retractor .....	251
Jameson Caliper .....	11	Kelly Haemostatic Forceps .....	120
Jameson Needle Holders .....	164	Kelly Intestinal Rectal .....	348
Jamison Super Cut Scissors .....	84	Kelly Operating Scissors .....	46
Janden Ear Curette .....	498	Kelly Retractor .....	243, 258, 260, 261
Jansen Bone Curettes Double-ended .....	444	Kelly Scissors T.c. ....	91
Jansen Ear Forceps .....	507	Kelly Sponge & Dressing Forceps .....	161
Jansen Retractor .....	265	Kern Bone Holding Forceps .....	431
Jansen-Gruenwald Dressing Forceps .....	104	Kerrison Bone Punche .....	528
Jansen-Middleton Septum Forceps .....	525	Kerrison Puncher .....	412
Jatho Biopsy Forceps .....	558	Kevorkian Suction Curettes .....	377
Jatho Nasopharynx Forceps .....	558	Kevorkian Uterine Biopsy Forceps .....	392, 393
Javid Vascular Clamps .....	319	Kevorkian-Pacific Uterine Biopsy Forceps .....	390
Jean Tissue & Dressing Forceps .....	101	Key Handle .....	421
Jeweler Type, Dissecting Forceps .....	112	Key Periosteal Elevator .....	461, 463, 465
John Hopkins Haemostatic Forceps .....	140	Key Dermal Punch .....	532
John-Hopkins Bulldog Holding Forceps .....	292	Key Modif. Dermal Punch .....	532
Johns-Hopkins (Potts Modif.) Clamp .....	320	Kidney Tray (German Pattern) .....	565
Johnson Needle Holders .....	168	Kidney Tray With Cover (English Pattern) .....	565
Johnson Prostatic Needle Holder .....	358	Kielland Obstetrical Forceps .....	399
Joll (Friedman) Thyroid- & Veginel Retractor .....	276	Kielland-Luikart Obstetrical Forceps .....	400
Jones / Perforating Towel Forceps .....	148	Killian Applicator .....	198
Jorgenson Operating Scissors .....	40	Killian Elevator .....	521, 523
Joseph Alar Hooklet .....	515	Killian Nasal Speculum .....	508, 511
Joseph Hooklet .....	203	Killian Septum Forceps .....	512, 525
Joseph Nasal Saws .....	516	Killian Septum Gouge .....	517
Joseph Operating Scissors .....	45	Killian-Claus Septum Gouge .....	517
Joseph Rasp .....	527	Killner Scissors .....	48
Joseph Scissors T.c. ....	92	Kilner Alar Hooklet .....	515
Judd-Allis Intestinal Forceps .....	331	Kilner Hook .....	206
Julian Needle Holders T.c. ....	183	Kilner Hooklet .....	202



## INDEX

DESCRIPTION	PAGE #	DESCRIPTION	PAGE #
Kilner Needle Holders T.c. ....	173	Kuehne Cilia Forceps.....	113
Kilner Needle Holders.....	167	Kuemmel Retractor.....	249, 256
Kilner Operating Scissors.....	45		
Kilner-Doughty Mouth Gage.....	539	<b>L</b>	
Kirschner Retractor.....	287	La Forceps Adenotomes.....	551
Kirschner.....	478	Laborde Tongue Holding Forceps.....	554
Kirschner-Balfour Retractor.....	287	Lahey (Sweet) Haemostatic Forceps.....	137
Kirstein Nasal Scissors.....	514	Lahey Clinic Nerve Hooks.....	416
Klapp Retractors.....	229	Lahey Goiter Retractor.....	227
Kleinert Kutz Elevator & Dissector.....	452	Lahey Retractors.....	227
Kleinert-Kutz Bone Rongeurs.....	483	Lahey Tonsil Forceps.....	542
Klinikum Berlin Tubing Clump.....	150	Lambert-Kay Vascular Clamps.....	304
Klinkenbergh-Loth Vascular Scissors.....	61	Lambotte Bone Holding Forceps.....	431
Knapp Iris Scissors.....	49	Lambotte Hooklets.....	212
Knee Retractor.....	224	Lambotte Osteotome.....	457, 459, 519
Knight Nasal Scissors.....	63	Lambotte Periosteal Elevators.....	464
Knight Septum Forceps.....	513	Landau Retractor.....	369
Knighthon Retractor.....	266	Landau Trocar.....	22
Knowles Scissors.....	79	Landolt Laminectomy Rongeur.....	407
Knutson Urethrographie-Instrument.....	359	Landolt Operating Scissors.....	65
Kocher Haemostatic Forceps.....	128	Landolt Scissors.....	66
Kocher Hooklets.....	211	Landolt Suction Tube.....	23
Kocher Intestinal Clamps.....	336, 338	Landolt Suction Tubes.....	24
Kocher Retractor.....	219, 220, 222, 253	Landon Vaginal Retractor.....	367
Kocher Tonsil Dissector.....	547	Lane Bone Holding Forceps.....	431
Kocher-Langenbeck Retractors.....	221	Lane Intestinal Clamp Forceps.....	344
Kocher-Ochsner Haemostatic Forceps.....	127	Lane Intestinal Forceps.....	335
Kocher-Wagner Retractor.....	222	Lane Periosteal Elevators.....	462
Koenig Tuning Forks.....	496	Lane Tissue Forceps.....	102
Koerte Retractor.....	233, 256	Lange Alar Hooklet.....	515
Kogan Endo Cervical Speculum.....	374	Lange Hook.....	206
Kogan Gyne Endo Cervical Speculum.....	374	Lange Suture Forceps.....	200
Koenig Retractors.....	215	Lange Tonsillectomy Forceps.....	560
Korte-Wagner Retractors.....	233	Lange-Hohmann Retractor.....	467
Krause Nasal Polypus Snare.....	514	Langenbeck Ear Curette.....	498
Krause Tonsillectomy Forceps.....	560	Langenbeck Knife.....	34, 36
Krause Trocar.....	22	Langenbeck Needle Holders T.c.....	189
Krause-Voss Nasal Polypus Snare.....	514	Langenbeck Periosteal Elevators.....	463-465
Krayenbuhl Hooklet.....	204	Langenbeck Retractor.....	223-225
Kristeller Vaginal Specula.....	365	Langenbeck-Delicate Needle Holders T.c.....	189
Kristeller Vaginal Specula (Upper & Lower Blades).....	364	Langenbeck-Mini Retractor.....	213
Kristeller Vaginal Speculum.....	363	Langenbeck-Ryder Needle Holders T.c.....	189
Kronecker Needle.....	192	Large Countersink.....	420
Kronlein Haemostatic Forceps.....	151	Laryngeal Mirror.....	552

# INDEX



DESCRIPTION	PAGE #	DESCRIPTION	PAGE #
Laryngeal Mirror Handle .....	552	Forceps .....	152
Laryngoscope & Accessories .....	07	Lister-Excentric Bandage Scissors .....	79
Laryngoscope Conventional & Fiberoptic Set(Double Set) .....	08	Liston Bone Cutting Forceps .....	486, 487
Laryngoscope Holder .....	557	Liston Knives .....	34
Lateral Vaginal Retractor Blue Coated Leep / Lietz .....	372	Liston-Key (Horsley) Bone Cutting Forceps ....	488
Lateral Vaginal Retractor .....	372	Liston-Stille Bone Cutting Forceps .....	487
Lathbury-Farrel Applicator .....	198, 199	Littauer / Liston Bone Cutting Forceps .....	486
Lawrence Haemostatic Forceps .....	134	Littauer Cilia Forceps .....	113
Le Grange Scissors .....	66	Littauer Stitch Scissors .....	67
Lead Hand .....	473	Little Retractor .....	229, 469
Lebsche Sternum Chisel .....	327	Little Wood Tissue Forceps .....	335
Leedham Tissue & Dressing Forceps.....	101	Littler Scissors .....	48
Lees Vascular Clamps .....	304	Litwak General Utility Scissors .....	58
Legueu Retractor .....	253, 284	Litwin Angled Scissors .....	55
Leksell Bone Rongeur .....	484	Lockhart-Mummery Probe .....	196
Leksell Rongeur Forceps.....	485	Locking Pliers .....	474
Leksell-Stille Bone Rongeur .....	482	Locklin Scissors .....	51
Leland-Jones De Bakey Vascular Clamps.....	306	Lockwood Intestinal Forceps .....	333
Lempert Bone Rongeurs .....	481	Long Haemostatic Forceps.....	142
Lempert Ear Curette .....	498	Lopez-Reinke Suction Tube .....	19
Lerche Tissue Forceps .....	99	Lorenz Scissors .....	79
Leriche Retractor .....	249	Lorer-Reinke Tonsil Suction Dissector.....	547
Lewin Bone Clamp .....	432	Lorna Towel Forceps .....	149
Lewis Rasp .....	526	Loute Vise Grip Pliers .....	474
Lexer Gouge .....	455	Love Gruenwald Laminectomy Rongeur .....	409
Lexer Modif. Gouge .....	455	Love Retractor .....	216
Lexer Modif. Osteotome .....	455	Love Tonsil Snares .....	549
Lexer Operating Scissors T.c.....	87	Love-Gruenwald Laminectomy Rongeurs .....	404
Lexer Osteotome .....	455	Love-Kerrison Laminectomy Punch.....	411
Lexer Scissors .....	44	Lower Haemostatic Forceps.....	137
Lexer-Baby Scissors.....	44	Lowman-Hoglund Bone Clamp.....	432
Leyla Self-Retaining Brain Retractor .....	401	Lowmann Bone Clamp .....	432
Lichtenberg Needle Holders T.c.....	188	Lubet-Barbon Septum Forceps .....	512
Lichtenberg Needle Holders .....	170	Luc Septum Forceps .....	513
Lichtwitz Antrum Trocar .....	20	Lucae / Ent Dressing Forceps .....	104
Lichtwitz Trocar.....	22	Lucae Ear Forceps .....	507
Ligature Needles .....	192-194	Lucae Ear Hooklet .....	500
Lightweight-Adson Tissue Forceps.....	107	Lucae Hooklet.....	205
Lincole Vascular Scissors .....	61	Lucae Mallets .....	440
Lister Bandage Plaster Scissors T.c. ....	92	Lucae Tuning Forks .....	495, 496
Lister Bandage Scissors.....	77, 79	Lucae Tympanum Needle.....	497
Lister Bougies Catheter .....	354	Lucas Bone Curettes Double-ended .....	443
Lister Sinus Forceps Sponge & Dressing		Luer Bone Rongeur .....	479, 480
		Luer Retractor.....	555
		Luer Retractors .....	230



## INDEX

DESCRIPTION	PAGE #	DESCRIPTION	PAGE #
Luer Suction Tubes.....	20	Masson-Luethy Needle Holders .....	166
Luer Tracheal Tubes.....	553	Masson-Lutti-Bozeman Needle Holders T.c .....	184
Luethy-Beck Needle Holders T.c .....	189	Mathieu Needle Holders .....	169
Lukens Hooklets .....	213	Mathieu Rectal.....	347
Lukens Retractor .....	555	Mathieu Retractors .....	230
Lumbar Lamina Spreader.....	419	Mathieu Vaginal Retractor .....	367
Lumbar, Cervical Impactors & Drivers .....	447	Mathieu Vaginal Speculum .....	366
Luniatscheck Tonsil Dissector .....	546	Mathieu-Ryder Needle Holders T.c.....	188
<b>M</b>		Mathieu-Ryder Vascular Needle Holders T.c. ....	188
M.G.H (Mass. General Hospital)		Mathieu-Stille Needle Holders T.c.....	186
Needle Holders .....	165	Matin Tonsil Snares .....	549
Mac + Miller Combo Laryngoscope Set.....	08	Matson Retractor .....	467
Mac + Miller Combo Laryngoscope .....	08	Maurer-Collin Cutting Forceps.....	328
Mac Disposable Laryngoscope Set.....	09	Mayfield Bone Rongeur .....	482, 484
Mac Laryngoscope Set.....	09	Mayo Abdominal Retractor .....	261
Macdonald Dissector .....	521	Mayo Dissecting Scissors .....	41
Macphail Needle Holders .....	169	Mayo Operating Scissors T.c.....	86
Magill Catheter Forceps .....	04	Mayo Rochester Needle Holders.....	169
Maier Sponge & Dressing Forceps.....	155	Mayo Super Cut Scissors .....	84
Malleable Retractor .....	264	Mayo Uterine Sounds .....	383
Malleolar Bone Holding Forceps .....	434	Mayo-Adams Retractor.....	269
Malleolar Countersink.....	420	Mayo-Adams Retractor.....	273
Mallets .....	439	Mayo-Blake Gall Stone Forceps .....	356
Maltz Rasp.....	526	Mayo-Collin Retractors .....	232
Mannerfelt Hooklet .....	205, 218	Mayo-Harrington Dissecting Scissors.....	58
Mannerfelt-Langenbeck Hooklet .....	205	Mayo-Hegar Needle Holders T.c.....	175
Marbach Bandage Scissors.....	78	Mayo-Hegar Needle Holders .....	162
Markham/Meyerding Retractor .....	268	Mayo-Noble Dissecting Scissors .....	41
Markwalder Bone Cutting Forceps .....	486	Mayo-Robson Intestinal Clamps.....	336
Marquardt Bone Rongeur .....	484	Mayo-Russian Tissue Forceps .....	103
Marschik-Krone Tonsil Holding Forceps .....	541	Mayo-Stille Dissecting Scissors .....	41
Martel Haemostatic Forceps.....	154	Mayo-Stille Operating Scissors T.c.....	87
Martin Applicator.....	199	Mc Indoe Bone Cutting Forceps .....	487
Martin Obstetrical Measuring Forceps.....	398	Mc Indoe Scissors .....	62
Martin Retractor.....	250	Mc Kenzie Clip Applying Forceps .....	418
Martin Uterine Sounds .....	383	Mc Kenzie Hand Drills .....	402
Martin Vaginal Specula .....	370	Mcgee Micro Ear Forceps .....	506
Martin-Cartilage Scissors .....	62	Mcindoe Tissue & Dressing Forceps .....	101
Martini Bone Curettes Double-ended .....	444	Mcintosh Laryngoscope Set .....	06
Masing Alar Hooklet.....	515	Mcivor Mouth Gage .....	537
Masing Osteotome .....	517	Mclean Obstetrical Forceps .....	399
Masson Needle Holders T.c.....	184	Mead Bone Rongeur .....	480
Masson Needle Holders .....	166	Mead Mallets .....	440
		Measuring Jug .....	566
		Medicine Cup Graduated.....	566

# INDEX



DESCRIPTION	PAGE #	DESCRIPTION	PAGE #
Meeker Haemostatic Forceps.....	124	Millin's Suction Tube .....	13
Mesh Basket .....	568	Mills Scissors .....	53
Metal Nasal Tips .....	494	Mills Vascular Needle Holders T.c .....	185
Metzenbaum Delicate Scissors T.c. ....	89, 90	Milne Murray Obstetrical Forceps.....	400
Metzenbaum Dissecting Scissors .....	42, 43	Mini Countersink .....	420
Metzenbaum Needle Holders T.c.....	186	Mini Drill Sleeve .....	427
Metzenbaum Needle Holders .....	168	Mini Lambotte Osteotomes.....	457
Metzenbaum Super Cut Scissors .....	83	Mini Lexer Gouge .....	455
Metzenbaum-Baby Dissecting Scissors .....	43	Mini Otoscope Set .....	05
Metzenbaum-Jamison Dissecting Scissors .....	43	Mini-Gemini Haemostatic Forceps .....	133
Metzenbaum-Lahey Scissors T.c.....	91	Mini-Roux Retractors .....	231
Meyerding Retractor .....	229, 251, 468	Mini-Townsend Uterine Biopsy Forceps .....	392
Michel Suture Forceps.....	200	Mirco Cup Forceps .....	415
Micro Alligator Forceps .....	415	Miskimon Retractor.....	269, 270
Micro Alligator Scissors .....	415	Mixer Gall Stone Forceps .....	357
Micro Derf Needle Holders T.c.....	181	Mixer Haemostatic Forceps.....	132, 137
Micro Dissecting Scissors.....	75	Mixer Operating Scissors .....	40
Micro Ear Forceps & Mastoid Rongeurs .....	504	Mixer-O'Shaugnessy Haemostatic Forceps ....	132
Micro Ear Forceps .....	503, 506	Moberg Retractor .....	209
Micro Forceps .....	109, 110	Mod. Martin Dressing Forceps .....	96
Micro Grasping Forceps .....	415	Mod. Michel Suture Forceps.....	200
Micro Hook .....	471	Mod. USA Tissue Forceps .....	100
Micro Needle Holders .....	171	Mod-bonn Operating Scissors .....	65
Micro Ryder Needle Holders T.c. ....	172	Model USA Spreader .....	81
Micro Scissors .....	71-76	Model USA Vise Grip Pliers .....	474
Micro-Adson Haemostatic Forceps .....	124	Modell Piccolo Applicator.....	198
Micro-Halsted Haemostatic Forceps .....	120	Modell Tubingen Retractor .....	250
Microsurgery Needle Holders T.c.....	184, 186	Modell USA Dressing Forceps.....	107
Microvascular Needle Holders T.c. ....	172, 177	Modell Wurzburg Mouth Gage.....	537
Middeldorpf Cheek Retractor.....	540	Modified Wien Nasal Speculum.....	508, 511
Middeldorpf Retractors .....	227, 228	Modified-USA Gynecology Scissors .....	78
Mikulicz Haemostatic Forceps.....	129, 143	Mogen Circumcision Clamp.....	359
Mikulicz Retractors .....	243, 245	Mollinson Tonsil Dissector .....	546
Miller Alveotomy File.....	453	Mollison Retractor .....	267, 273
Miller Disposable Laryngoscope Set .....	09	Molt Mouth Gag .....	535
Miller Dressing Forceps .....	104	Möltgen Caliper.....	11
Miller Laryngoscope Set .....	09	Morris Retractor .....	260
Miller Rasp.....	526	Morris-De Bakey Vascular Clamps .....	298
Miller Retractor .....	209	Morse Scissors .....	58
Miller-Colburn Bone File .....	453	Morse-Favaloro Sternal Retractor .....	323
Miller-Colburn Rasp .....	526	Mouth Gag, Lip & Cheek Retractors.....	536
Milligan Cranial Rongeurs .....	417	Mouth Gage.....	538, 539
Milligan Retractor.....	268	Moynihan Gall Duct Dilator .....	353
Millin Bladder Neck Spreader .....	359	Moynihan Haemostatic Forceps .....	129
Millin Capsule Forceps .....	358	M-Schmidt Tongue Depressor .....	534





## INDEX

DESCRIPTION	PAGE #	DESCRIPTION	PAGE #
Murphy Retractors .....	212	Non-Perforating Towel Forceps .....	148
Museux Tenaculum Forceps .....	375	Norfolk & Norwich Retractor .....	274
Museux Tonsil Forceps .....	545	Northbent Stitch Scissors .....	67
<b>N</b>			
Nabatoff Varicose Vein Probe Complete Set .....	330	Noto Sponge & Dressing Forceps .....	161
Naegele Obstetrical Forceps .....	399	Nott Vaginal Speculum .....	362
Naegele Perforator Forceps .....	395	Novak Suction Cannula Curette .....	384
Nager Tonsil Snares .....	549	Noyes Micro Scissors .....	71, 73
Nail Extracting Forceps .....	472	Nussbaum Intestinal Clamp Forceps .....	345
Nail Extractor .....	476	Nussbaum Intestinal Clamps .....	340
Nail Nipper .....	201	<b>O</b>	
Nail Scissors .....	70	O'Brien Needle Holders T.c .....	184
Nail Splitting Forceps .....	472	O'Brien Vascular Scissors .....	54
Nasal Scissors & Nasal Tompon .....	514	O'Shaughnessy Haemostatic Forceps .....	123
Nasal Speculum .....	508-511	O'Sullivan - O'connor Retractor .....	282, 373
Nasal Suction Tube .....	531	Ochsner Suture Forceps .....	200
Naunton Morgan Needle Holders .....	164	Ochsner Trocar .....	22
Needle Case .....	564, 566	Ochsner Vascular Clamps .....	293
Needle Holders T.c .....	172-175, 177-189	Oldberg Laminectomy Rongeur .....	407
Needle Holders .....	162-171, 176	Olivecrona Knives .....	33
Needle Nose Pliers .....	473, 476	Olivecrona Vascular Scissors .....	61
Negus Chest Support For Mouth Gag .....	539	Olivecrona Dura Dissectors .....	470
Negus Haemostatic Forceps .....	129	Olivecrona Nasal Scissors .....	514
Negus Suction Dissector .....	521	Ollier Retractors .....	227, 235
Neivert Chisel .....	518	Olsen-Hegar Needle Holders T.c .....	174, 179
Neivert Hooklets .....	213	Olsen-Hegar Needle Holders .....	166, 176
Neivert Needle Holders T.c .....	182	Ombredanne Mallet .....	441
Neivert Needle Holders .....	167	Operating Fine Scissors .....	65
Nelaton Probe .....	196	Operating Laryngoscope .....	557
Nelson Lung Dissecting Scissors .....	57	Operating Scissors .....	65
Nelson Tissue Forceps .....	102	Operating, Dissecting Scissors T.c .....	91
Nelson Trocar .....	21	Operating, Dissecting Scissors .....	39, 40, 42, 45, 46
Nelson Trocar .....	22	Ortho / With Plastic Caps Mallet .....	441
Nerve Probe Endoscopic .....	451	Ortho Bone Clamp .....	432
Neumann Vascular Scissors .....	59	Ortho Mallet .....	441
Neuro-Duoflex Hammer .....	01	Orthopaedic Mallet .....	441
Neutral & Load Drill Guide .....	427	Orthopaedics Wire Cutter .....	490
New Orleans Needle Holders T.c .....	172, 179	Osteotomes .....	519
New Orleans Needle Holders .....	165, 176	Otoscope / Ophthalmoscope Set .....	05
New Port Vaginal Retractor .....	372	Otoscope Set .....	05
News Hooklet .....	555	Overholt Haemostatic Forceps .....	131
Niro Hooklet .....	203	Overholt-Geissendoerfer Haemostatic Forceps .....	131
Nissen Haemostatic Forceps .....	125	Overholt-Mixer Haemostatic Forceps .....	125

# INDEX



DESCRIPTION	PAGE #	DESCRIPTION	PAGE #
<b>P</b>			
Parametrium Haemostatic Forceps .....	139	Plaster Scissors .....	77-79
Parametrium Operating Scissors T.c. ....	87	Plaster Shears .....	80
Parker Retractors .....	232	Plester Retractor .....	269, 271
Parker-Langenbeck Retractors .....	232	Plester Suction Tube .....	18, 19
Parker-Mott Retractors .....	232	Plester Suction Tube .....	531
Partsch Gouges .....	458	Plester Tympanum Needle .....	499
Partsch Mallets .....	440	Ploitzer Ear Specula .....	493
Patella Bone Holding Forceps .....	434	Politzer Air Douche .....	494
Paul Hooklet .....	209	Politzer Tympanum Needle .....	497
Payr Intestinal Clamp .....	343	Pool Suction Tube .....	16
Payr-Baby Intestinal Clamp .....	343	Poots-Smith Dressing Forceps .....	98
Pean Haemostatic Forceps .....	125, 128, 129, 151	Potts Tenotomy Scissors .....	49
Pederson Vaginal Speculum Leap / Lietz .....	360	Potts Vascular Clamps .....	295
Pederson Vaginal Speculum .....	360	Potts-De Martel Scissors .....	53
Peers-Bertman Towel Forceps .....	149	Potts-Reynolds Tenotomy Scissors .....	49
Peet Splinter Forceps .....	115	Potts-Smith Dressing Forceps T.c. ....	118
Pelkmann Sponge Forceps .....	159	Potts-Smith Scissors T.c. ....	93
Pelvic Instruments .....	437	Potts-Smith Scissors .....	53, 62
Pelvic Reduction Forceps Asymmetric .....	436	Potts-Smith Super Cut Scissors .....	84
Pelvic Reposition Forceps .....	435-437	Potts-Smith Tissue Forceps .....	98
Penfield Dura Dissectors .....	417	Potts-Smith Vascular Scissors .....	52, 57
Penfield Elevator Endoscopic .....	451	Pozzi Gyne Tenaculum Forceps .....	374
Penfield Elevators .....	452	Pozzi Tonsil Forceps .....	543
Pennington / Siezing Haemostatic Forceps .....	154	Pratt Etmoid Curettes .....	550
Pennington Raspatory .....	522	Pratt Gyne Uterine Dilators .....	387
Pennybacker Periosteal Elevators .....	463	Pratt Haemostatic Forceps .....	154
Penzuoli Vascular Clamps .....	311	Pratt Rectal .....	347
Percussion Hammers .....	01, 02	Pratt Tenaculum Forceps .....	375
Percy Retractor .....	438	Presbyterian Tubing Clump .....	150
Perforated Baskets .....	568	Price Thomas De Bakey Vascular Clamps .....	319
Perforated Box .....	562	Price-Thomas De Bronchus Clamp .....	319
Perforated Tray .....	563	Prince Scissors .....	64
Periosteal Elevator .....	461, 466	Probes .....	197
Perkins Retractor .....	271	Prostatic Retractor .....	352
Perthes Reamer .....	453	Providence-Hospital Haemostatic Forceps .....	120
Phaneuf Haemostatic Forceps .....	142	Pryor-Pean Retractor .....	255
Phaneuf Haemostatic Forceps .....	144	Putti Elevators .....	453
Pierce Trocar .....	22		
Pin Wrench .....	425	<b>Q</b>	
Pinard Aluminium Stethoscopes .....	03	Quinby Vascular Scissors .....	60
Pinard Wooden Stethoscopes .....	03	Quire Ear Polypus Forceps .....	501
Piper Obstetrical Forceps .....	399		
Pituitary Rongeur .....	413		



## INDEX

DESCRIPTION	PAGE #	DESCRIPTION	PAGE #
<b>R</b>			
Rabiner Hammer .....	02	Richardson Retractor.....	259
Ragnell Scissors T.c. ....	92	Richardson Retractors .....	258
Ragnell-Davis Retractors .....	215	Richardson/kelly Retractor .....	251
Ralk Bone Drills .....	422	Richardson-Eastman Retractor .....	259
Ralk Splinter Forceps.....	115	Richter Operating Scissors .....	40
Ramathibodi Tubal Hook .....	372	Richter Retractor .....	266
Ramathibodi Uterine Manipulator .....	372	Richter-Heath Suture Forceps .....	200
Ramplsey Sponge Forceps .....	160	Righby Retractor.....	270
Ramsay Tissue & Dressing Forceps .....	101	Ring Cutter .....	472
Ramsay Tissue & Dressing Forceps .....	101	Roberts Haemostatic Forceps .....	135
Randall Kidney Stone Forceps .....	350	Robinson's Periosteal Elevators .....	462
Raney Clip Applying Forceps .....	418	Rochard Retractor .....	284
Rankin Haemostatic Forceps .....	121, 122	Rochester Needle Holders T.c .....	183
Raspatory .....	471	Rochester-Carmalt Haemostatic Forceps 128, 129	
Ratchet Fixation Bone Holding Forceps .....	434	Rochester-Pean Haemostatic Forceps.....	126
Ray Pituitary Curette .....	446	Roder Tonsil Snares .....	549
Razor .....	36	Roeder Towel Forceps.....	148
Recamier Uterine Curette.....	379, 380	Rogge Sterilizing Forceps .....	569
Reduction Bone Holding Forceps .....	434	Rollet (Blair) Hook .....	209
Reduction Forceps .....	434	Rollet Hook .....	209
Rees Scissors T.c .....	91	Rollet Hooklet .....	202
Reil Bone Holding Forceps .....	434	Roosevelt Intestinal Clamp Forceps .....	346
Reiner Ear Syringe .....	502	Rose Retractor .....	230, 555
Renal Artery Clamng Forceps .....	318	Rosen Ear Specula.....	493
Resano Dressing Forceps T.c.....	117	Rosen Tympanum Needle .....	499, 500
Resano Intestinal Forceps .....	337	Rosenbrg Tonsillectomy Forceps.....	560
Resano Vascular Scissors .....	57	Roser-Konig Mouth Gag .....	535
Resection Knife .....	36	Ross Retractor.....	252
Retractor .....	224	Round Badpan.....	567
Retractor For Knee .....	467	Round Cut Scissors .....	66
Retractor.....	213-216	Roux Cheek Retractor .....	540
Retractors ....219-223, 225-226, 228-236, 239-247		Roux Retractors.....	231
Retractors, Vein Hooks.....	251	Roux-Magnus Retractors.....	231
Reverdin Needles .....	190, 191	Rubio Wire Twister T.c. ....	180
Reverdin Retractor .....	264	Rumel Haemostatic Forceps .....	132
Reynolds Operating Scissors .....	45	Ruskin Bone Rongeur .....	484
Rhoton Micro Dissection Instruments .....	450	Ruskin Bone Rongeurs.....	483
Rhoton-Merz Brain Retractor Set .....	401	Ruskin Bone Splitting Forceps .....	488
Rib Elevator Endoscopic .....	449	Ruskin-Liston Bone Cutting Forceps .....	487
Rib Retractors.....	323	Ruskin-Mini Bone Rongeurs .....	483
Ribbon Retractor .....	264	Russel-Davis Mouth Gage.....	538
Ricard Retractor .....	285	Russian-Modell Tissue Forceps .....	103
Richardson Eastman Retractors.....	230	Rydel-Seiffer Tuning Forks .....	496
		Ryder French-Eye/Standard/Micro Needle Holders T.c.....	178

# INDEX



DESCRIPTION	PAGE #	DESCRIPTION	PAGE #
Ryder Needle Holders T.c.....	177	Schaedel Towel Forceps.....	148
<b>S</b>		Scheinmann Tonsillectomy Forceps .....	560
Saalfeld Milium Knife & Comedone Extractor...324		Scherback Vaginal Specula .....	371
Sachs Cranial Rongeurs.....	417	Schindler Haemostatic Forceps.....	140
Sachs Hooklet .....	203	Schlesinger Laminectomy Rongeur.....	406
Sachs Nerve Elevator .....	452	Schmeden Nasal Cutting Forceps .....	529
Sachs Nerve Hooks .....	416	Schmieden Needle .....	191
Sachs Nerve Separator & Spatula.....	416	Schmieden-Dick Needle .....	191
Saenger Placenta Forceps .....	396	Schmieden-Taylor Vascular Scissors.....	61
Safety Super Cut Scissors.....	82	Schmieden-Taylor .....	60
Sairges Tenaculum Forceps .....	375	Schnidt / Sawtell Haemostatic Forceps .....	124
Samii.....	105	Schoemaker-Loth Scissors.....	66
Sanvenero Operating Scissors .....	45	Schoenbore Retractors .....	215, 229, 555
Saroot Haemostatic Forceps .....	123	Schröder Gyne Tenaculum Forceps .....	374
Sarot Needle Holders T.c.....	182	Schröder Tenaculum Forceps.....	374
Sarot Needle Holders T.c.....	174	Schroeder Tonsil Forceps.....	542-544
Sarot Needle Holders T.c.....	178	Schroeder Uterine Scoops .....	377
Sarot Needle Holders .....	163	Schuardt Rib Sternum Shears .....	329
Satinsky De Bakey Vascular Clamps.....	310	Schubert Biopsy Forceps .....	394
Satinsky Vascular Scissors.....	61	Schuhknecht Retractor .....	270
Satterlee Saw .....	36	Schuknecht Tympanum Needle.....	499
Satterlee Saw .....	438	Schuknecht Wire Cutting Scissors .....	69
Sauerbruch Retractors .....	235, 236, 239	Schulze Uterine Flushing Tube.....	386
Sauerbruch Rib Sternum Shears.....	329	Schulze-Bergmann Intestinal Rectal .....	348
Sauerbruch Rongeur Forceps .....	485	Schumacher Bandage Scissors .....	78
Sauerbruch-Frey Bone Nibblers .....	327	Schumacher Sternum Shears .....	327
Sawtell Haemostatic Forceps .....	123	Schumacher Uterine Biopsy Forceps .....	390
Sawyer Retractors .....	258	Schumacher-Nan-Doren Biopsy Forceps .....	395
Scaler Box .....	564	Schweckendiek Tonsil Scissors .....	533
Scaler Tray .....	564	Scoville Bone Curettes .....	445
Scalp-Contour Retractor .....	266	Scoville Nerve Hooks .....	416
Scalpel Handle .....	25, 26, 28	Scoville Retractor .....	216, 468
Scalpel Handle #3 .....	25	Scoville Ruptured Disc Curette.....	445
Scalpel Handle #3 / Graduated .....	25	Scoville-Richter Retractors .....	283
Scalpel Handle #3 Long Angled .....	26	Screw Driver .....	424
Scalpel Handle #4 .....	25	Screw Forceps .....	425
Scalpel Handle 3l Long.....	26	Screw Nut Wrench .....	478
Scalpel Handle 4l .....	25	Scudder Intestinal Clamps.....	340
Scalpel Handle 4l Long.....	26	Sebileau Elevator .....	460
Scalpel Handle, #7 .....	26	Sedillot Periosteal Elevators .....	462
Scalpel Handle, #3, #4 .....	26	Segond Knives .....	33
Scalpel Handles .....	27	Segond Myoma Knife .....	376
Scalpel Plastic Handle .....	25, 26	Segond-Landau Haemostatic Forceps .....	140
		Seiffert Applicator.....	198
		Self - Centering Bone Holding Forceps .....	430



## INDEX

DESCRIPTION	PAGE #	DESCRIPTION	PAGE #
Sellers Rib Contractor .....	320	Sims Suction Curettes .....	377
Semb Bone Cutting Forceps .....	488	Sims Uterine Curette .....	381-384
Semb Bone Holding Forceps .....	328, 430	Sims-Kelly Retractor .....	261
Semb Bone Rongeurs .....	483	Sims-Maier Sponge & Dressing Forceps .....	156
Semken Dressing Forceps .....	97	Sims-Special Uterine Sounds .....	383
Semken Tissue Forceps .....	99	Singley-Tuttle Intestinal Tissue Forceps .....	103
Semm Retractor .....	286	Singley-Tuttle Tissue Forceps .....	103
Semm Vaginal Speculum.....	362	Sinus & Ethmoid Curettes .....	550
Senn Mallow Retractor .....	214	Skene Tonsil Forceps .....	543
Senn Retractor .....	469	Skull Traction Tongs.....	403
Senn-Green Retractors .....	215	Sleeve Holding .....	424
Senning Needle Holders T.c. ....	173	Slip Joint Vise Grip Pliers .....	474
Senning Needle Holders.....	165	Sluder-Ballenger Tonsil Snares .....	549
Senn-Mueller Retractors.....	214	Small Countersink .....	420
Septum & Periosteal Elevators .....	523	Smellie Decapitating Hook .....	395
Septum Chisels, Septum Gouges .....	517	Smellie Perforator Forceps .....	395
Septum Elevators & Periosteal Elevators .....	520	Smith (Mod. USA) Scissors .....	79
Septum Elevators, Periosteal Elevators .....	521	Smith Peterson Gouges .....	456, 458
Septum Forceps .....	512, 513, 525	Smith Peterson Osteotomes.....	456
Septum Osteotome.....	519	Smith Wire Cutting Scissors .....	69
Septum, Periosteal Elevators .....	522	Smith-Blue Intestinal Rectal .....	348
Seutin Shears .....	489	Smith-Peterson Gouge .....	459
Sexton Tympanum Needle .....	497	Smith-Peterson Osteotome .....	459
Seyffert Vaginal Speculum.....	361	Smithwick Hook & Dissector.....	451
Shapleigh Ear Curette .....	498	Snellen Curette .....	499
Sharp Hook.....	425	Socket Wrench .....	425
Shaving Mug.....	567	Somer Kidney Stone Forceps.....	351
Shortbent Stitch Scissors .....	67	Spatula .....	198
Siebold Scissors .....	47	Speaking Tube.....	553
Siegle Diagnostic Head Complete Set .....	494	Spencer / Delicate Stitch Scissors .....	67
Silver Chisel .....	518	Spencer Coronary Needle Holders T.c .....	186
Simon / Schroder Uterine Scoops .....	378	Spencer Stitch Scissors .....	67
Simon Bone Curettes .....	443	Spencer-Wells Haemostatic Forceps .....	125
Simon Bone Curettes .....	446	Sphenoid Bone Punches .....	528
Simon Hook .....	206	Splinter Forceps.....	114
Simon Knives .....	34	Split Lamp.....	565
Simon Retractor.....	250	Spratt Bone Curettes .....	442
Simon Vaginal Speculum.....	366	Spratt Bone Curettes .....	445
Simplex Tongue Depressor.....	540	Sprit Lamp .....	566
Simpson Obstetrical Forceps .....	399	Spurling Laminectomy Rongeur .....	406
Simpson Uterine Sounds.....	383	Sputum Mug .....	567
Simpson-Braun Obstetrical Forceps.....	399	S-Shaped Retractors .....	242
Sims Operating Scissors T.c.....	88	St Clair Thompson Elevator.....	522
Sims Rectal .....	347	St. Clair-Thomson Adenoid Curettes .....	551
Sims Scissors .....	47	St. Marks Retractor.....	254

# INDEX



DESCRIPTION	PAGE #	DESCRIPTION	PAGE #
St. Thomas Periosteal Elevators .....	462	Strandell-Stille Retractors .....	215, 229
Stacke Applicator .....	198	Strassmann Kidney Stone Forceps .....	351
Standard Curved Dressing Forceps .....	96	Stratte Needle Holder .....	358
Standard Dressing Forceps T.c.....	116	Stratte Needle Holders T.c .....	183
Standard Dressing Forceps .....	95, 96	Stratte Needle Holders .....	164, 176
Standard Mod. USA Dressing Forceps.....	96	Strully Vascular Scissors .....	59
Standard Narrow Dressing Forceps .....	96	Strümpel Alligator Ear Forceps .....	502
Standard Operating Scissors .....	38	Struycken Nasal Cutting Forceps .....	529
Standard Operating Scissors T.c. ....	85, 86	Struycken Septum Forceps .....	512
Standard Operating Scissors.....	37	Struycken Tonsillectomy Forceps .....	560
Standard Straight Dressing Forceps .....	96	Subramanian De Bakey Vascular Clamps.....	315
Standard Super Cut Scissors .....	83	Suction Tube .....	13-15
Standard Tissue & Dressing Forceps T.c.....	116	Suction Tube .....	16-19, 23, 24
Standard Tissue Forceps T.c. ....	116	Sullivan Scissors .....	64, 82-84
Standard Tissue Forceps.....	95	Sweet Esophageal Scissors .....	56
Standard Trocar .....	21	Syme Tonsil Dissector .....	546
Staude-moore Tonsil Forceps.....	543		
Stellbrink Synovectomy Rongeur .....	480	<b>T</b>	
Sterilizing Drums .....	561	Takahashi Laminectomy Rongeur .....	408
Sternberg Retractors .....	214	Takahashi Tonsil Punch Forceps .....	529
Sternberg Tongue Depressor.....	540	Tap Handle .....	437
Sternum Needle Holders T.c.....	180	Tap Sleeve .....	427
Stethoscopes .....	03	Taps .....	420
Stevens Micro Forceps .....	110	Tarnier Obstetrical Forceps .....	400
Stevens Tenotomy Super Cut Scissors .....	82	Tauber Vaginal Spatula.....	262
Stevens Tissue Forceps T.c .....	111	Tay-Bronson Pituitary Curette.....	446
Stieglitz Forceps .....	115	Taylor Dressing Forceps .....	97
Stieglitz Splinter Forceps .....	115	Taylor Hammer .....	01
Stille Bone Rongeurs .....	483	Taylor Retractor .....	230, 468
Stille Dressing Forceps.....	96	Taylor Tissue Forceps.....	99
Stille Gouges .....	456, 458	Teale Tenaculum Forceps.....	375
Stille Haemostatic Forceps .....	136	Teale Tonsil Forceps .....	544
Stille Osteotomes .....	456	Tendon Forceps .....	473
Stille Plaster Shears .....	80, 489	Tendon Hooks Retractors .....	229
Stille Rongeur Forceps .....	485	Tenotomy Dissecting Scissors .....	50
Stille Tissue Forceps .....	100	Tenotomy-Stevens Dissecting Scissors.....	50
Stille-Barraya Tissue Forceps.....	102	Thole Obstetrical Measuring Forceps.....	398
Stille-Listo Bone Cutting Forceps .....	487	Thoms-Gaylor Biopsy Forceps .....	394
Stille-Luer Bone Rongeur .....	482	Thomson Walker Needle Holders.....	164
Stille-Luer Rongeur Forceps.....	485	Thomson-Walker Needle Holders T.c .....	184
Stille-Ruskin Bone Rongeur .....	482	Thomson-walker's Penile Clamps .....	148
Stitch Scissors .....	67	Thoracic / Cardiovascular .....	309
Stone Tissue Forceps .....	99	Thoracic Rib Retractor.....	324
Strabismus Scissors T.c.....	94	Thoracic/Cardiovascular .....	310
Strabismus Scissors .....	48		



## INDEX

DESCRIPTION	PAGE #	DESCRIPTION	PAGE #
Thorek Scissors .....	44	Trousseau Tongue Holding Forceps .....	554
Thorek-Feldman Scissors .....	44	Troutman Micro Scissors .....	72
Thudichum (Golfsmith) Nasal Speculum .....	509	Troutman-Chris Blade Holder .....	28
Tieck-halle Nasal Speculum .....	510	Tubbs Dilator Forceps .....	321
Tischler Biopsy Forceps .....	394	Tubing Clump .....	150
Tischler Uterine Biopsy Forceps .....	389, 392, 393	Tuebinger Modell Retractor .....	269
Tischler-Kevorkian Uterine Biopsy Forceps .....	389	Tuffier / Haberer Retractor .....	264
Tischler-Morgan Uterine Biopsy Forceps .....	393	Tuffier Haemostatic Forceps .....	154
Tissue & Dressing Forceps T.c .....	111, 118	Tuffier Intestinal Forceps .....	332
Tissue & Dressing Forceps .....	95	Tuffier Retractor .....	244, 245
Tissue Forceps .....	119	Tuffier Rib Retractor .....	323, 324
Tissue Lifter .....	471	Tumarkin Ear Specula .....	493
Tivnen Tonsil Seizing Forceps .....	507	Tuning Forks .....	495, 496
Tobold Laryngeal Polypus Forceps .....	558	Turner-Doyen Retractors .....	252
Tobold Tongue Depressor .....	534	Tyding Tonsil Snares Forceps .....	548
Toenis Dissecting Scissors .....	58	Tydings Tonsil Seizing Forceps .....	507
Toennis Dura Dissectors .....	470	Tympanum Needle & Ear Curettes .....	498
Toennis Hooklet .....	202	Tympanum Needle .....	497
Toennis Needle Holders T.c .....	186		
Toennis Needle Holders .....	170	<b>U</b>	
Toennis Nerve Hooks .....	416	Uckermann Tracheotomy Trocar .....	554
Toennis Vascular Scissors .....	60	Uffenorde bone Curettes .....	443
Toennis-Adson Scissors T.c .....	94	Ulrich Bone Holding Forceps .....	430, 431
Toennis-Adson Vascular Scissors .....	60	Ulrich Sponge Forceps .....	158
Tohoku Towel Forceps .....	149	Univ. Minnesota Tongue Depressor .....	540
Tongue Depressor .....	534	Universal (Colour Available) .....	77
Tonsil Forceps .....	545	Universal Bandage Scissors .....	77
Tonsil Grasping Forceps .....	542	Universal Bone Rongeurs .....	479
Tonsil Snares .....	548, 549	Universal Laryngeal .....	557
Tonsil, Nasal Scissors .....	63	Universal Scissors T.c .....	492
Tonsillectomy Forceps Exchangeable Tips .....	560	Universal Scissors .....	477
Townley Caliper .....	11	Universal Trocar .....	20
Tracheotomy Set .....	556	Unna Comedone Extractor .....	324
Traction Cable .....	330	Urinal - Female .....	567
Traube Hammer .....	02	Urinal - Male .....	567
Travers Retractor .....	270	Uro-Tangential Gall Stone Forceps .....	357
Trelat Vaginal Speculum .....	362	Usa Retractors .....	230
Trethowan's Periosteal Elevators .....	462	Us-Army Retractors .....	230
Treves Tissue & Dressing Forceps .....	101	Uterine Biopsy Forceps .....	389
Trocar .....	15	Utility Shears .....	489
Trocars / Suction Tubes .....	20	Utility Sterilizing Forceps .....	569
Trocars .....	21, 22		
Troeltsch Ear Forceps .....	507		
Troemner Hammer .....	01		
Troemner-Simplex Hammer .....	01		

# INDEX



DESCRIPTION	PAGE #	DESCRIPTION	PAGE #
<b>V</b>			
Vacuum Curettes .....	385	Wangensteen Dressing Forceps T.c. ....	118
Vaginal Specula & Retractors .....	369	Wangensteen Dressing Forceps .....	98
Vaginal Specula, Vaginal Retractors.....	367	Wangensteen Needle Holders T.c. ....	175
Vaginal Speculum .....	366	Wangensteen Needle Holders .....	166, 168
Valleix Uterine Sounds.....	383	Wangensteen Tissue Forceps T.c. ....	118
Van Buren Dilator.....	354	Wartenberg Pinwheel .....	02
Van Doren Biopsy Forceps .....	395	Wash Basin.....	565
Vascular Scissors .....	52-61	Wassmund Retractors .....	229
Vascular, Dissecting & Plaster Scissors T.c. ....	92	Watron-Ceyne Raspatory .....	521
Vascular, Dissecting Scissors T.c. ....	93	Watson-Williams Bone Punche .....	528
Vascular, Enterotomy Scissors .....	62	Watson-Williams Tonsil Punch Forceps.....	529
Vein Artery Clamp Forceps .....	289	Weber Aesthesiometer .....	03
Verbrugge Bone Holding Forceps .....	433	Weber Vascular Clamps .....	297
Vernier Caliper .....	11	Webster Needle Holders T.c. ....	182
Vezien Operating Scissors .....	46	Webster Needle Holders.....	162
Vickers Mallets.....	440	Wecker Micro Scissors .....	71
Vienna Nasal Speculum.....	511	Weider Tongue Depressor .....	534
Virchow Dissecting Knives.....	35	Weil - Blakesley Laminectomy Rongeur .....	414
Vise Grip Pliers .....	475	Weil-blakesley Bone Punche .....	528
Vogel Trocar .....	22	Weil-Blakesley Laminectomy Rongeur .....	408
Volkman Retractor .....	214	Weinberg Vagotomy Retractor (Joe's Hoe) .....	252
Volkman Bone Curettes Double-ended .....	444	Weingärtner Alligator Ear Forceps.....	502
Volkman Bone Curettes .....	442	Weissbarth Vaginal Specula .....	369
Volkman Hooklets .....	212	Weitlaner Retractor.....	271, 272
Volkman Retractors .....	212, 233, 234	Wertheim Haemostatic Forceps .....	144, 146, 147
Voltolini (Dplay) Nasal Speculum .....	509	Wertheim Needle Holders T.c. ....	173
<b>W</b>			
Wachenfeldt Suture Forceps .....	200	Wertheim Needle Holders.....	166
Wagener Ear Hooklet .....	500	Wertheim Parametrium Clamps.....	145, 146
Wagener Hooklet .....	205	Wertheim-Cullen Haemostatic Forceps .....	147
Wagner Gum Scissors .....	64	Westcott Micro Scissors .....	72, 73
Wagner Laminectomy Rongeur .....	408	Westermark Haemostatic Forceps .....	141
Walb Dissecting Knives .....	35	Westmacott Septum Forceps .....	512
Waldmann Bandage Scissors.....	78	Wetheim Operating Scissors .....	46
Wallich Ovum Forceps.....	396	White Tonsil Forceps .....	542
Walsham Septum Forceps .....	530	Whitehead Mouth Gag.....	536
Walter Chisel .....	518	Whitehead-Jennings Mouth Gag .....	536
Walton Operating Scissors .....	65	Wickham Bulldog Holding Forceps.....	292
Walton Retractor.....	266	Wickham Mini Bulldog Holding Forceps .....	292
Walton-Liston Bone Cutting Forceps .....	487	Wiener Hook.....	202
		Wikstroem Haemostatic Forceps.....	136
		Wilde Intervertebral Disc Laminectomy Rongeur .....	414
		Wilde Nasal Polypus Snare .....	514
		Willet-Martel Haemostatic Forceps.....	154
		Willett Obstetrical Forceps.....	397





## INDEX

DESCRIPTION	PAGE #	DESCRIPTION	PAGE #
William Lacrimal Probes .....	195	Yasargil .....	105
Williams Intestinal Forceps .....	331	Yasargil-Sami Tissue Forceps .....	104
Williams Screw Driver .....	424	Yeomann Biopsy Punching Forceps .....	341
Williger Bone Curettes Double-ended .....	444	Young Needle .....	191
Williger Bone Curettes .....	442	Young Prostatic Retractor .....	352
Williger Mallets.....	440	Young Retractor .....	256
Williger Periosteal Elevators .....	462	Young Tongue Holding Forceps.....	554
Williger Retractor .....	273		
Wilmer Iris Scissors .....	49		
Winkelmann Circumcision Clamp .....	359		
Winter Placenta Forceps .....	396		
Winterton Vaginal Speculum.....	362		
Wire Bending Pliers .....	477		
Wire Cutter .....	477		
Wire Cutter T.c.....	492		
Wire Cutters.....	491		
Wire Cutting Pliers T.c .....	492		
Wire Cutting Scissors .....	68, 69		
Wire Cutting Scissors T.c.....	94		
Wire Forceps .....	476		
Wire Instruments .....	477		
Wire Retaining Retractor .....	265		
Wire Tightening Pliers .....	475		
Wire Tightening Pliers T.c. ....	180		
Wire Twisters T.c.....	180		
Wittner Uterine Biopsy Forceps.....	391		
Wolff Plaster Shears .....	489		
Wolff Saw.....	81		
Woodson Dural Separator/packer .....	452		
Woodson Elevator/spatula.....	452		
Wrigley Obstetrical Forceps.....	400		
Wuaugh Tissue & Dressing Forceps .....	101		
Wullstein Micro Ear Forceps.....	505		
Wullstein Retractor .....	270		
Wullstein Suction Tube .....	23		

## Y

Yankauer Hooklet .....	203
Yankauer Suction Tube.....	17, 20
Yasargil Haemostatic Forceps .....	125
Yasargil Laminectomy Rongeur.....	407
Yasargil Lure-Lock Cone Suction Tubes.....	24
Yasargil Suction Tube .....	23
Yasargil Tissue Forceps.....	104

## Z

Zaikind Lung Retractor .....	261
Zaufal Ear Hooklet.....	500
Zaufal-Jansen Bone Rongeurs .....	483
Zenker Haemostatic Forceps .....	134
Zenker Retractor.....	226, 263
Ziegler Cilia Forceps .....	113
Zöllner Ear Polypus Forceps .....	501
Zollner Ear Specula .....	493
Zweifel Needle Holders T.c.....	189

*Certified:*

- ✧ ISO 9001-2008 U.K.    ✧ ISO 13485-2003 U.K.  
✧ CGMP-FDA U.S.A.    ✧ CE Mark Registered MDA U.K.  
✧ Hygenically Approved (Instruments)  
Certified By Our Government



## ***Raiz & Sajjad Surgical (PVT) LTD.***

***Manufacturers - Exporters & Importers of Surgical, Dental, Laparoscopic,  
Veterinary Instruments & all sort of Scissors***

Postal Add:- P.O. Box 2947, Sialkot-1, Pakistan.  
Head Office Factory:- Jail Road, Sialkot-1 Pakistan.  
E-mail: [msmughal@raizent.com](mailto:msmughal@raizent.com)  
[rsent@brain.net.pk](mailto:rsent@brain.net.pk)  
Web : [www.raizent.com](http://www.raizent.com)

TEL : +92-52-4274284-4293451  
DIR. : +92-52-8104409  
FAX : +92-52-4264284-4293450